

PRODUCT NUMBER
SEE TABLE

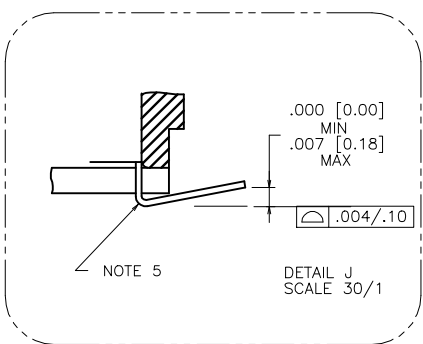
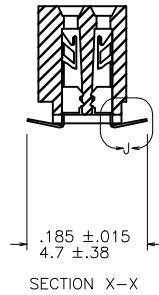
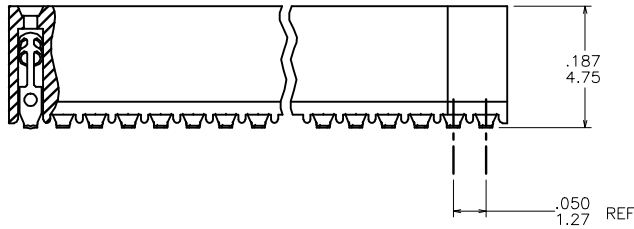
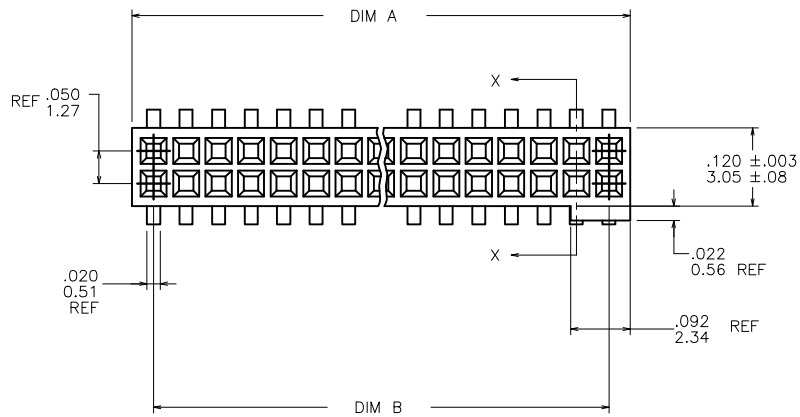

mat'l. code		surface		tolerance		projection		product family	
-		ISO 1302		ISO 406 ISO 1101		1st angle		RIBCAGE	
itr		ecn no		dr		date		title	
T		V10994		DLW		03/09/01		.050 CC VERT. C.C. ASS'Y.	
U		V11874		CRG		08/22/01		SUR. MOUNT-POL.	
V		M05-0123		MHT		06/06/05		scale 4:1	
W		M06-0225		ERE		06/12/08		dwg no	
X		M06-0370		MHT		09/26/08		sheet 1 of 3	
Y		M08-0053		CMR		02/27/08		size	
AA		M09-0058		CMR		4/06/09		A3	
sheet		revision		AA		AA		type	
index		sheet		1		2		Product Customer Drawing	

FCJ
FCconnect.com
Copyright FCJ

form A3

PRODUCT NO. NOTE 9	SIZE	DIM A	DIM B	SPECIAL PACKAGING	TAPE WIDTH		PCS. PER REEL
						PITCH	
87022-605	2 X 5	.266/6.76	.200/5.08	NOTE 7	16mm	12mm	750
-610	2 X 10	.516/13.11	.450/11.43	NOTE 7	24mm	12mm	750
-615	2 X 15	.766/19.46	.700/17.78	NOTE 7	32mm	12mm	500
-620	2 X 20	1.016/25.81	.950/24.13	NOTE 7	44mm	12mm	500
-625	2 X 25	1.266/32.16	1.200/30.48	NOTE 7	44mm	12mm	500
-630	2 X 30	1.516/38.51	1.450/36.83	NO	---	---	---
-635	2 X 35	1.766/44.86	1.700/43.18	NO	---	---	---
-640	2 X 40	2.016/51.21	1.950/49.53	NO	---	---	---
-645	2 X 45	2.266/57.56	2.200/55.88	NO	---	---	---
87022-650	2 X 50	2.516/63.91	2.450/63.23	NO	---	---	---
87022-625 MIL.	2 X 25	1.266/32.16	1.200/30.48	NO	---	---	---

NOTE 6

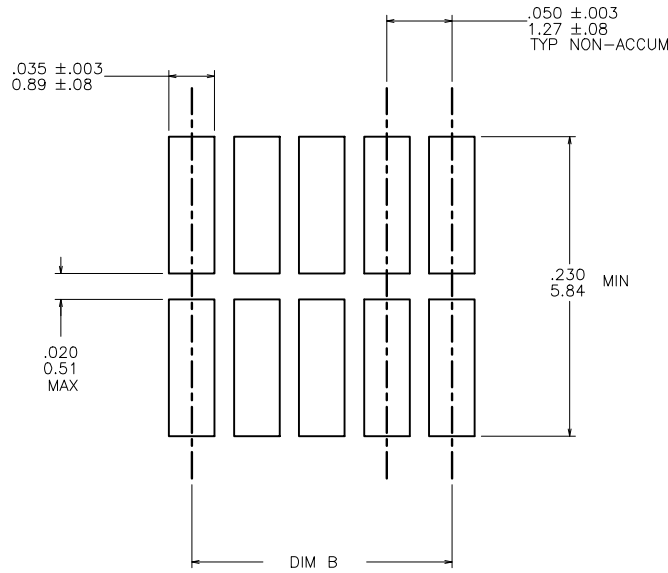
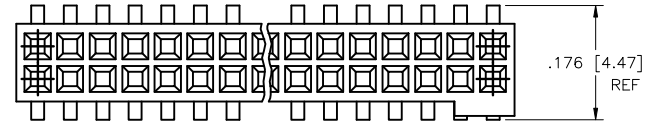

FIGURE "A"
RECOMMENDED PCB
MOUNTING PAD PATTERN

NOTES :

- HOUSING MATERIAL :
LCP GLASS FILLED . FLAME RETARDANT PER UL94V-0.
COLOR : NATURAL
- TERMINAL MATERIAL : BeCu
- TERMINAL PLATING :
30u"/.76u MIN HARD GOLD OVER Ni ON CONTACT ZONES.
100u"/2.54u MIN Sn. OVER Ni IN SOLDERING ZONES.
OTHERWISE GOLD FLASH OR UNPLATED. MATTE TIN FINISH
AT SOLDERING ZONE.
- APPLICATION INFORMATION:
A. RECOMMENDED MOUNTING PAD PATTERN IS
SHOWN IN FIGURE "A".
B. MATING PINS TO BE .0176/.447 TO .0181/.459 DIA.
C. MATING PIN TIPS TO BE IN TRUE POSITION TO MATING
GRID WITHIN .008/.20 DIA.
D. SUGGESTED MATING PIN LENGTH .130/3.30
 $\pm .010/.25$.
- LEAD TIPS TO BE ABOVE HEEL, UP TO .007/.18 MAX.
COPLANARITY TO BE MEASURED AT LOWEST POINT (HEEL).
- SOLDERTAIL SHALL BE FINISHED IN ACCORDANCE WITH MIL-STD-1276.
HOT SOLDER DIP (FINISH 51) OR FUSED (REFLOWED) TIN LEAD PLATE
(FINISH 34). 100u"/2.54u MIN.



- ADD "TR" TO END OF DASH NUMBER FOR TAPE AND REEL PACKAGING
WITH CAP. TOOLED ONLY FOR NOTED CONNECTORS.
- ADD "CT" TO END OF DASH NUMBER FOR CONNECTOR WITH
VACUUM CAP IN TUBE.
- ADD "LF" SUFFIX AT THE END OF PART NUMBER FOR LEAD FREE OPTION.
- THIS PRODUCT MEETS EUROPEAN UNION DIRECTIVES AND OTHER
COUNTRY REGULATION AS DESCRIBED IN GS-22-008.
- THE HOUSING WILL WITHSTAND EXPOSURE TO 260°C PEAK TEMPERATURE
FOR 20 SECONDS IN A CONVECTION, INFRA-RED OR VAPOR PHASE REFLOW
OVEN. SEE APPLICATION NOTES/PROCEDURES IF THEY ARE AVAILABLE.

mat'l. code	surface	tolerance	projection	product family
-	ISO 1302	ISO 406	INCH/MM	RIBCAGE
ltr	ecp no	dr	date	title
AA				.050 CC VERT. C.C. ASS'Y. SUR. MOUNT-POL.
	angles	linear	scale	dwg no
	0'±2'	.XX±.01/0.3	4:1	87022
		.XXX±.005/0.13		sheet 2 of 3
		.XXXX±.0020/0.051		size
	dr	D. SHEAFFER	12/6/88	A3
	engr	J. OSWALD	12/6/88	
	chr	J. OSWALD	12/6/88	
	appd	J. OSWALD	12/6/88	
sheet	revision			type
index	sheet			Product Customer Drawing

PRODUCT NUMBER
SEE TABLE

REFERENCE ONLY

TAPE WIDTH'S 32mm AND ABOVE HAS BOTH FEED TRACKS,
BELOW 32mm HAS TOP FEED TRACK ONLY.

UNREELING
DIRECTION

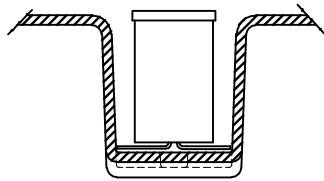
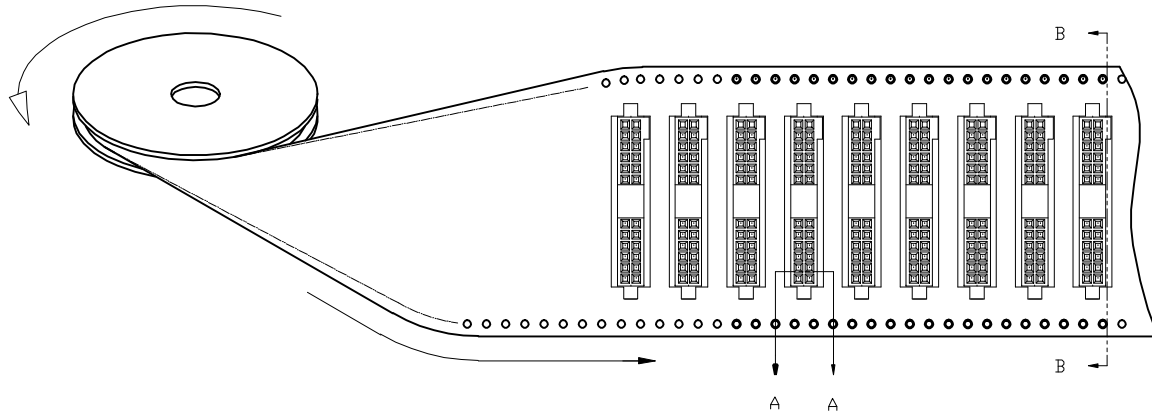

SECTION A-A

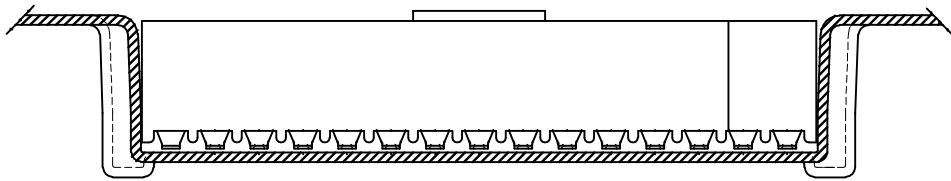

SECTION B-B



Copyright FCJ

mat'l. code		surface		tolerance		projection		product family	
-		ISO 1302		ISO 406				RIBCAGE	
ltr		ecn no		dr		date		title	
AA								.050 CC VERT. C.C. ASS'Y. SUR. MOUNT-POL.	
		angles		linear		INCH/MM		dwg no	
		0°±2'		.XX±.01/0.3		Scale 4:1		sheet 3 of 3	
				.XXX±.005/0.13				size	
				.XXX±.0020/0.051				A3	
dr		D. SHEAFFER		12/6/88				type	
engr		J. OSWALD		12/6/88				Product Customer Drawing	
chr		J. OSWALD		12/6/88					
appd		J. OSWALD		12/6/88					
sheet		revision							
index		sheet							

form A3