

PLEASE CHECK WWW.MOLEX.COM FOR LATEST PART INFORMATION

Part Number: [0877153918](#)

Status: **Active**

Overview:

Description: 1.00mm (.039") Pitch, PCI Express* Connector, 280 Circuits, Nylon 4/6 Glass-filled, Black Housing, Phosphor Bronze, 0.38µm (15µ") Gold (Au) Plating, with Plastic Pegs, 2.54mm (.100") Solder tail, Lead Free

Agency Certification

CSA LR19980

General

Product Family Edge Card Connectors
Series 87715
Component Type Edgecard to PCB
Overview pci_express_card_edge_connector
Product Name PCI Express*

Physical

Circuits (Loaded) 280
Circuits (maximum) 280
Circuits Detail All Signal
Durability (mating cycles max) 50
Entry Angle Vertical (Top Entry)
Flammability 94V-0
Keying to Mating Part Yes
Material - Plating Mating Gold
Material - Plating Termination Tin
PC Tail Length (in) 0.100 In
PC Tail Length (mm) 2.54 mm
PCB Locator Yes
PCB Retention Yes
PCB Thickness Recommended (in) 0.062 In
PCB Thickness Recommended (mm) 1.60 mm
Packaging Type Tray
Pitch - Mating Interface (in) 0.039 In
Pitch - Mating Interface (mm) 1.00 mm
Pitch - Term. Interface (in) 0.039 In
Pitch - Term. Interface (mm) 1.00 mm
Plating min: Mating (µin) 15
Plating min: Mating (µm) 0.38
Polarized to Mating Part Yes
Temperature Range - Operating -55°C to +85°C
Termination Interface: Style Through Hole

Electrical

Current - Maximum per Contact 1.1A
Voltage - Maximum 50V AC (RMS)/DC

Solder Process Data

Lead-free Process Capability Wave Capable (TH only)
Process Temperature max. C 260

Material Info

Reference - Drawing Numbers

Packaging Specification PK-87715-206
Product Specification PS-87715-206

EU RoHS

**ELV and RoHS
Compliant**

REACH SVHC

Not Reviewed

Halogen-Free

Status

Not Reviewed

China RoHS



**Need more information on product
environmental compliance?**

Email productcompliance@molex.com
For a multiple part number RoHS Certificate of
Compliance, [click here](#)

Please visit the [Contact Us](#) section for any
non-product compliance questions.

Search Parts in this Series

87715Series

Mates With

PCI Express Card

Sales Drawing
Test Summary

SD-87715-206
TS-87715-206

* PCI Express is a registered trademark of PCI-SIG®

This document was generated on 06/04/2010

PLEASE CHECK WWW.MOLEX.COM FOR LATEST PART INFORMATION

7 6 5 4 3 2 1

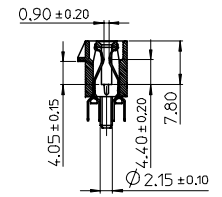
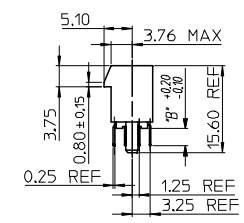
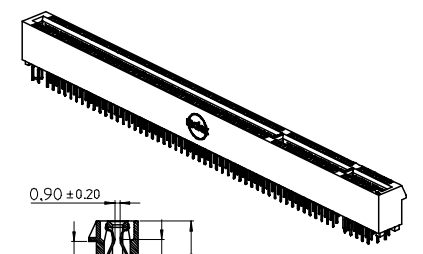
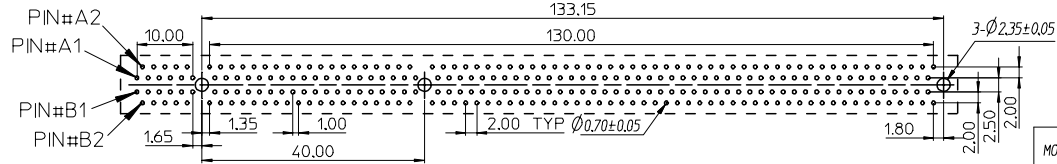
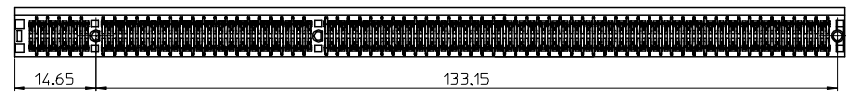
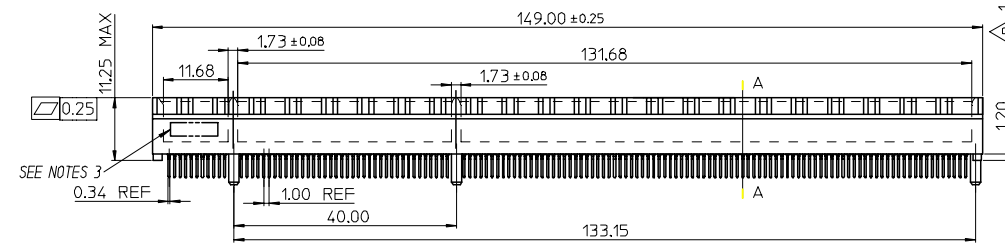
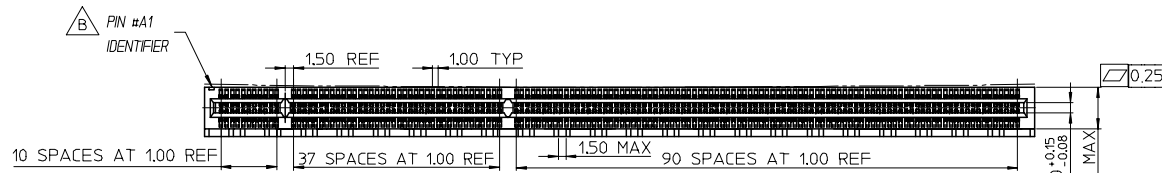

SECTION A-A

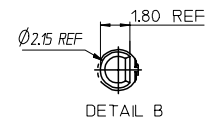

DETAIL B

- NOTES:
 1.MATERIALS:
 1-1.HOUSING:SEE TABLE GLASS FIBER FILLED UL94V-0
 COLOR:SEE TABLE
 1-2.CONTACT:SEE TABLE
 2.PLATING:
 2-1.CONTACT AREA:SEE TABLE
 2-2.SOLDER TAIL:SEE TABLE
 2-3.UNDER PLATING:SEE TABLE
 3.DATE CODE:TO BE PRINTED
 4.PRODUCT SPECIFICATION REFER TO PS-87715-200
 5.PACKAGE SPECIFICATION REFER TO PK-87715-206
 6.TEST SUMMARY:REFER TO TS-87715-206
 7.LEAD FREE AND ROHS COMPLIANT.

MOLEX PIN	CIRCUIT SIZE	HOUSING MATERIAL	HOUSING COLOR	TERMINAL MATERIAL	CONTACT PLATING	SOLDERTAIL PLATING	DIMB*
87715-3914	280	NYLON 46	BLACK	PHOSPHOR BRONZE	GOLD FLASH	100 MICRORINCH TIN OVER 50 MICRORINCH NICKEL OVERALL	3.00
87715-3915	280	NYLON 46	BLACK	PHOSPHOR BRONZE	15 MICRORINCH	100 MICRORINCH TIN OVER 50 MICRORINCH NICKEL OVERALL	3.00
87715-3916	280	NYLON 46	BLACK	PHOSPHOR BRONZE	30 MICRORINCH	100 MICRORINCH TIN OVER 50 MICRORINCH NICKEL OVERALL	3.00
87715-3917	280	NYLON 46	BLACK	PHOSPHOR BRONZE	GOLD FLASH	100 MICRORINCH TIN OVER 50 MICRORINCH NICKEL OVERALL	2.54
87715-3918	280	NYLON 46	BLACK	PHOSPHOR BRONZE	15 MICRORINCH	100 MICRORINCH TIN OVER 50 MICRORINCH NICKEL OVERALL	2.54
87715-3919	280	NYLON 46	BLACK	PHOSPHOR BRONZE	30 MICRORINCH	100 MICRORINCH TIN OVER 50 MICRORINCH NICKEL OVERALL	2.54

EWR 2006-0005 & 2006-0019 2005-0094 EC NO: SH2006-0100 DRWN:ALL IN 2006/05/15 CHKD: 2006/05/15 APPR:WWSCHANG 2006/05/16	QUALITY SYMBOLS ▽=0 ▽=0	GENERAL TOLERANCES (UNLESS SPECIFIED)		DIMENSION STYLE MM ONLY		SCALE	DESIGN UNITS	THIRD ANGLE PROJECTION		
			mm	INCH	DRAWN BY	DATE	TITLE			
		4 PLACES	± ---	± ---	TOM	2005/03/22	1.0 EDGE CARD 280 CKT VERTICAL DIP CONNECTOR (LEAD FREE VERSION)			
		3 PLACES	± ---	± ---	CHECKED BY	DATE				
2 PLACES	± 0.25	± ---	ALL IN	2005/03/22						
1 PLACE	± 0.25	± ---	APPROVED BY	DATE						
		ANGULAR ± 3 °		WWSCHANG	2005/03/22					
		DRAFT WHERE APPLICABLE MUST REMAIN WITHIN DIMENSIONS		MATERIAL NO.	DOCUMENT NO.	SHEET NO.				
				SEE TABLE	SD-87715-206	1 OF 2				
				SIZE	THIS DRAWING CONTAINS INFORMATION THAT IS PROPRIETARY TO MOLEX INCORPORATED AND SHOULD NOT BE USED WITHOUT WRITTEN PERMISSION					
				4						

6 5 4 3 2 1

7 6 5 4 3 2 1

E

D

C

B

A

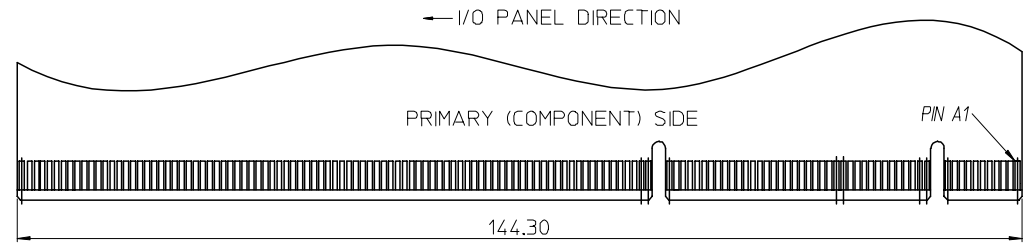
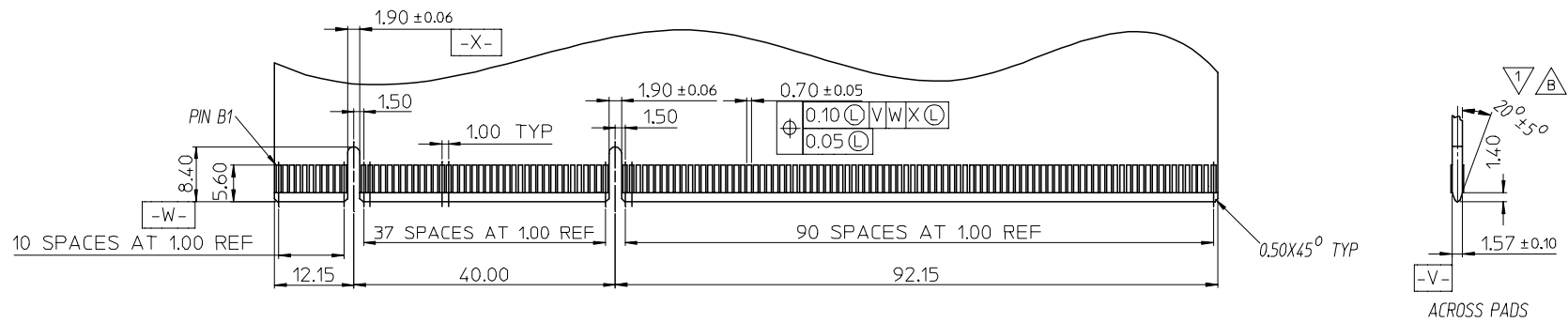

△ I/O PANEL → DIRECTION
DAUGHTER CARD
SECONDARY (SOLDER) SIDE

△ CHAMFER EDGES MUST BE FREE OF CUTTING BURRS.

SEE SHEET 1 EC NO: SH2006-0100 DRWN: ALL IN CHKD: APPR: WWSCHANG 2006/05/15 2006/05/15 2006/05/16	QUALITY SYMBOLS	GENERAL TOLERANCES (UNLESS SPECIFIED)		DIMENSION STYLE MM ONLY		SCALE 1:1	DESIGN UNITS METRIC	THIRD ANGLE PROJECTION	
	▽ = 0	mm	INCH	DRAWN BY	DATE	TITLE			
	□ = 0	4 PLACES ± ---	± ---	TOM	2005/03/22	1.0 EDGE CARD 280 CKT VERTICAL DIP CONNECTOR (LEAD FREE VERSION)			
		3 PLACES ± ---	± ---	CHECKED BY	DATE	MOLEX INCORPORATED			
		2 PLACES ± 0.25	± ---	ALL IN	2005/03/22	DOCUMENT NO. SD-87715-206			
	1 PLACE ± 0.25	± ---	APPROVED BY	DATE	SHEET NO. 2 OF 2				
		ANGULAR ± 3 °		WWSCHANG	2005/03/22	THIS DRAWING CONTAINS INFORMATION THAT IS PROPRIETARY TO MOLEX INCORPORATED AND SHOULD NOT BE USED WITHOUT WRITTEN PERMISSION			
		DRAFT WHERE APPLICABLE MUST REMAIN WITHIN DIMENSIONS		MATERIAL NO. SEE TABLE					
				SIZE 4					

ib_frame_A4_P_AM_T
Rev. D 2004/06/28

6 5 4 3 2 1