

XL CONNECTOR

5.0mm pitch/Disconnectable Crimp style connectors

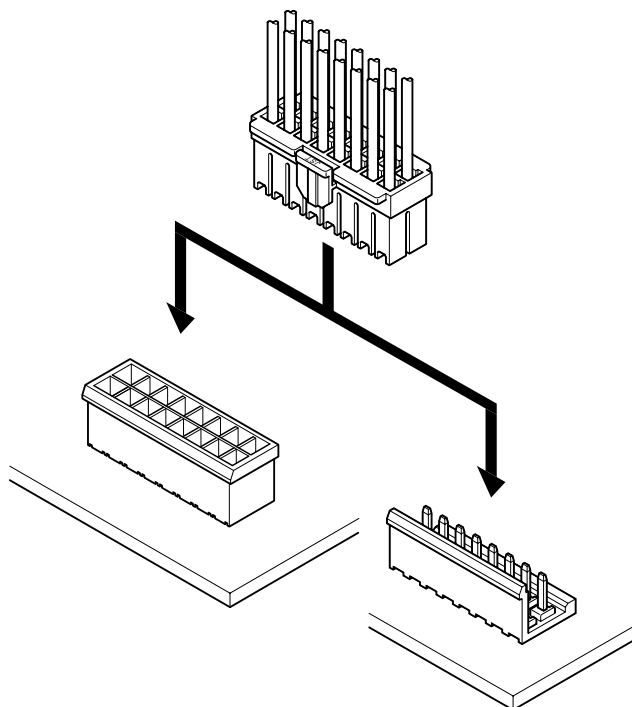

The reliable XL connectors have been developed by utilizing the technology of JST's field proven VH and SM connectors. The XL connectors are being used in electric appliances, vending machines, and office automation equipment.

- Reliable housing construction
- Easy contact insertion
- Box-shaped contact
- Two kinds of connections

Specifications

- Current rating: 10A AC, DC (Refer to the table below.)
- Voltage rating: 150V AC, DC
- Temperature range: -25°C to +90°C
(including temperature rise in applying electrical current)
- Contact resistance: Initial value/7m Ω max.
After environmental testing/10m Ω max.
- Insulation resistance: 1,000M Ω min.
- Withstanding voltage: 1,500V AC/minute
- Applicable wire: AWG #26 to #16
- Applicable PC board thickness: 1.6mm
- * Compliant with RoHS.
- * Refer to "General Instruction and Notice when using Terminals and Connectors" at the end of this catalog.
- * Contact JST for details.

Note:

The rated current varies depending on the number of circuits and the size of the wire to be connected by crimping.

Circuits	Wire size(AWG)					
	#16	#18	#20	#22	#24	#26
2	10	6	5	4	3	3
3	9	5	4	3	3	2
4	9	5	4	3	3	2
8	6	4	3	3	2	2
12	6	4	3	3	2	2
16	5	3	2	2	1	1

Current unit:A

Note:

Do not branch in parallel current which exceeds the rated current per circuit listed below. (Example: more than 10A in the case of a 2-circuit connector using AWG #16 wires.) If branched in parallel, current imbalance or other problems may develop.

Standards

Recognized E60389

Certified LR20812

R75150

Locking header PC board layout (viewed from soldering side) and Assembly layout

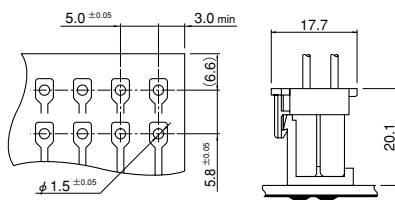

Note: 1. Tolerances are non-cumulative: ±0.05mm for all centers.

2. Hole dimensions differ according to the kind of PC board and piercing method. The dimensions above should serve as a guideline. Contact JST for details.

Shrouded header PC board layout (viewed from component side)

[HDS type]
Top entry type

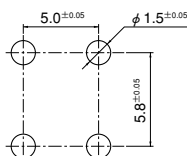

[HDS type]
Side entry type

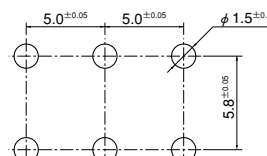

XL CONNECTOR

Shrouded header PC board layout (viewed from component side)

[HDB type] Top entry type

(2 circuits)

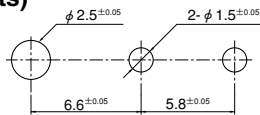

(4 circuits)

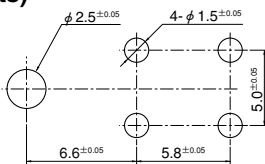

(3 circuits)

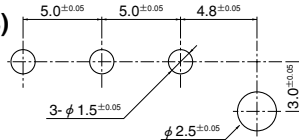

(6 circuits)

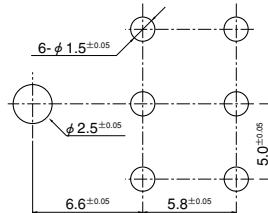

[HDB type] Side entry type

(2 circuits)

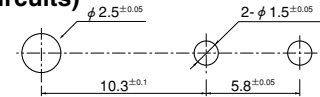

(4 circuits)

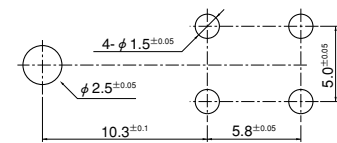

Note: 1. Tolerances are non-cumulative: ±0.05mm for all centers.

2. Hole dimensions differ according to the kind of PC board and piercing method. The dimensions above should serve as a guideline. Contact JST for details.

Contact

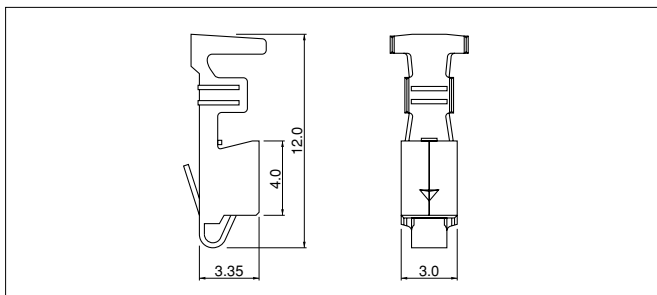

Model No.	Applicable wire		Insulation O.D. (mm)	Q'ty / reel
	mm ²	AWG #		
SXF-01T-P0.7	0.13~0.5	26~20	1.3~2.7	3,000
SXF-41T-P0.7	0.5 ~1.25	20~16	1.9~3.1	
	0.3×2~0.5×2	22×2~20×2	1.7×2~2.0×2	

Material and Finish

Phosphor bronze, tin-plated (reflow treatment)

RoHS compliance

Note: Contact JST for brass products.

Contact	Crimping machine	Applicator		
		Crimp applicator	Dies	Crimp applicator with dies
SXF-01T-P0.7	AP-K2N	MKS-L	MK/SXF-01-07	APLMK SXF01-07

Contact	Crimping machine	Applicator		
		Crimp applicator	Dies	Crimp applicator with dies
SXF-41T-P0.7	AP-K2N	MKS-L	MK/SXF-41-07	APLMK SXF41-07

Housing

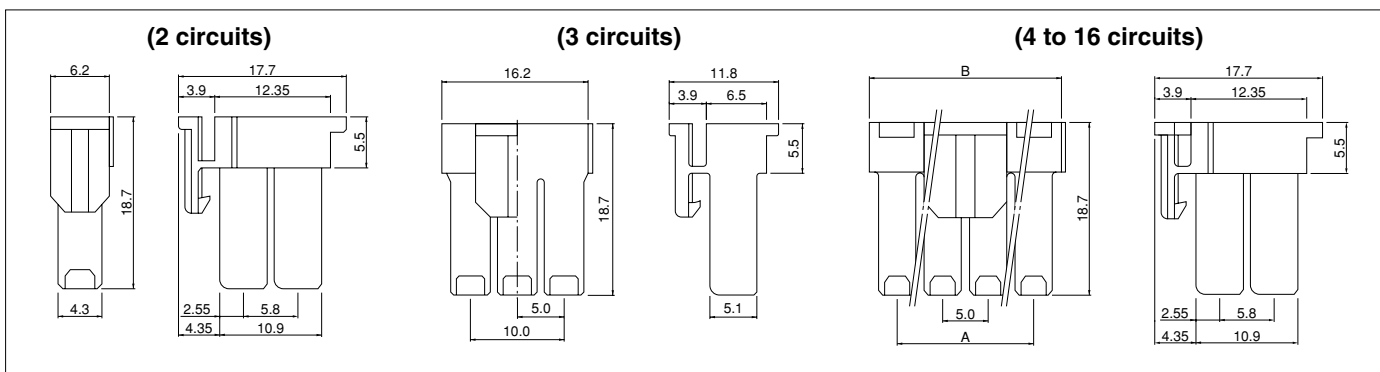

Circuits	Model No.	Dimensions (mm)		Q'ty / bag
		A	B	
2	XLP-02V	—	—	500
3	XLP-03V	—	—	500
4	XLP-04V	5.0	11.2	500
8	XLP-08V	15.0	21.2	500
12	XLP-12V	25.0	31.2	200
16	XLP-16V	35.0	41.2	200

Material

PA 66, UL94V-0, natural (white)

<For reference> As the color identification, the following alphabet shall be put in the underlined part. For availability, delivery and minimum order quantity, contact JST.

ex. **XLP-02V-oo**
(blank)...natural (white)
K...black R...red E...blue Y...yellow

XL CONNECTOR

Locking header

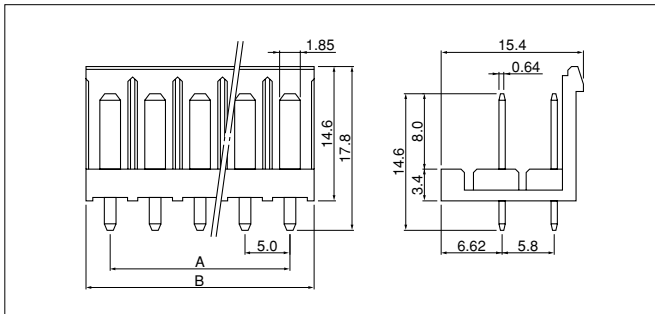

Circuits	Model No.	Dimensions (mm)		Q'ty / box
		A	B	
2	B02P-XL	—	5.0	250
4	B04P-XL	5.0	10.0	200
8	B08P-XL	15.0	20.0	100
12	B12P-XL	25.0	30.0	50
16	B16P-XL	35.0	40.0	50

Material and Finish

Post: Brass, copper-undercoated, tin-plated (reflow treatment)
Wafer: PA 66, UL94V-0, natural (white)

RoHS compliance This product displays (LF)(SN) on a label.

<For reference> As the color identification, the following alphabet shall be put in the underlined part. For availability, delivery and minimum order quantity, contact JST.

ex. **B02P-XL-oo**
(blank)...natural (white) K...black R...red E...blue Y...yellow

Shrouded header <HDB type>

Top entry type

(2 circuits)

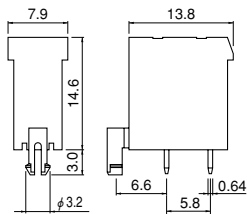

(3 circuits)

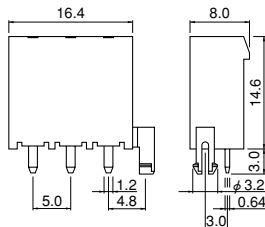
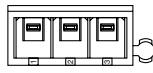

(4 circuits)

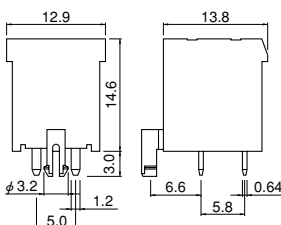
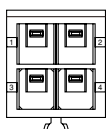

(6 circuits)

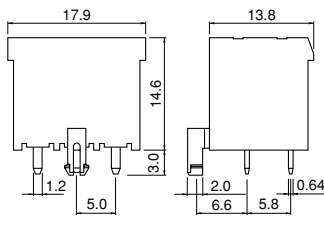
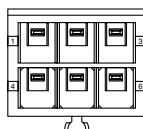

Side entry type

(2 circuits)

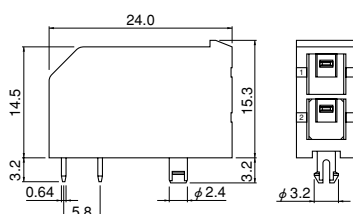
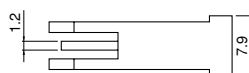

(4 circuits)

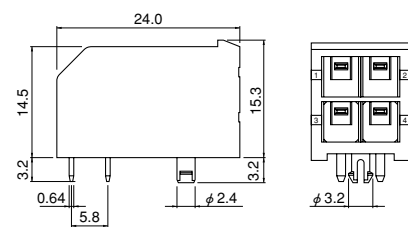
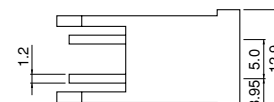

Circuits	Model No.		Q'ty / box	
	Top entry type	Side entry type	Top entry type	Side entry type
2	B02P-XL-HDB	S02P-XL-HDB	200	100
3	B03P-XL-HDB	—	200	—
4	B04P-XL-HDB	S04P-XL-HDB	200	100
6	B06P-XL-HDB	—	100	—

Material and Finish

Post: Brass, copper-undercoated, tin-plated (reflow treatment)
Wafer: PA 66, UL94V-0, natural (white)

RoHS compliance This product displays (LF)(SN) on a label.

<For reference> As the color identification, the following alphabet shall be put in the underlined part. For availability, delivery and minimum order quantity, contact JST.

ex. **B02P-XL-HDB-oo**, **S02P-XL-HDB-oo**
(blank)...natural (white)
K...black R...red E...blue Y...yellow
M...green H...gray N...brown D...orange
L...lemon yellow

XL CONNECTOR

Shrouded header <HDS type>

Top entry type

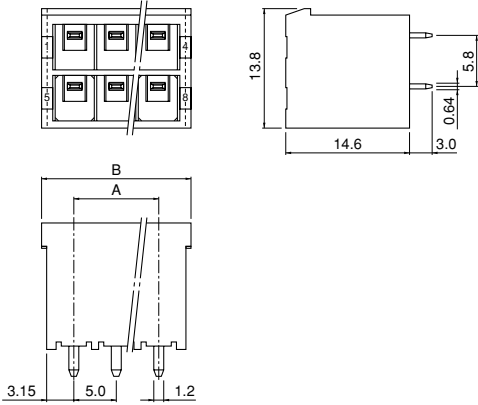

Side entry type

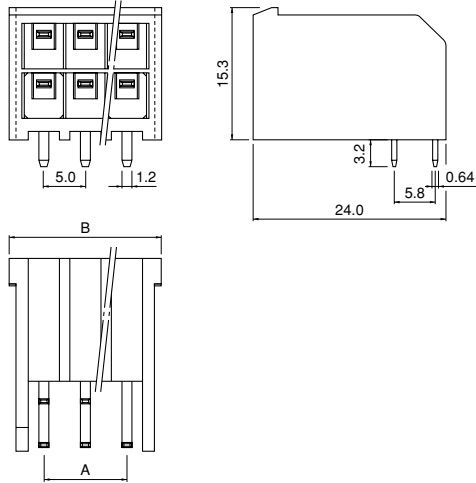

Circuits	Model No.		Dimensions (mm)		Q'ty	
	Top entry type	Side entry type	A	B	Top/bag	Side/box
2	B02P-XL-HDS	—	—	7.9	200	—
4	B04P-XL-HDS	—	5.0	12.9	200	—
8	B08P-XL-HDS	S08P-XL-HDS	15.0	22.9	100	40
12	B12P-XL-HDS	S12P-XL-HDS	25.0	32.9	50	30
16	B16P-XL-HDS	S16P-XL-HDS	35.0	42.9	40	20

Material and Finish

Post: Brass, copper-undercoated, tin-plated (reflow treatment)
Wafer: PA 66, UL94V-0, natural (white)

RoHS compliance This product displays (LF)(SN) on a label.

<For reference> As the color identification, the following alphabet shall be put in the underlined part. For availability, delivery and minimum order quantity, contact JST.

ex. **B08P-XL-HDS-oo**, **S08P-XL-HDS-oo**
(blank)...natural (white)
K...black R...red E...blue Y...yellow

Contact position location numbers

