

1000-mA, 6-MHz HIGH-EFFICIENCY STEP-DOWN CONVERTER IN CHIP SCALE PACKAGING

Check for Samples: [TPS62660](#), [TPS62665](#)

FEATURES

- 91% Efficiency at 6MHz Operation
- 31 μ A Quiescent Current
- Wide V_{IN} Range From 2.3V to 5.5V
- 6MHz Regulated Frequency Operation
- *Best in Class* Load and Line Transient
- $\pm 2\%$ Total DC Voltage Accuracy
- Automatic PFM/PWM Mode Switching
- Low Ripple Light-Load PFM Mode
- Fast Turn-On Time, <60- μ s Start-Up Time
- Integrated Active Power-Down Sequencing (Optional)
- Current Overload and Thermal Shutdown Protection
- Three Surface-Mount External Components Required (One MLCC Inductor, Two Ceramic Capacitors)
- Complete Sub 1-mm Component Profile Solution
- Total Solution Size <12 mm²
- Available in a 6-Pin NanoFree™ (CSP)

APPLICATIONS

- Cell Phones, Smart-Phones
- PDAs, Pocket PCs
- Portable Hard Disk Drives
- DC/DC Micro Modules

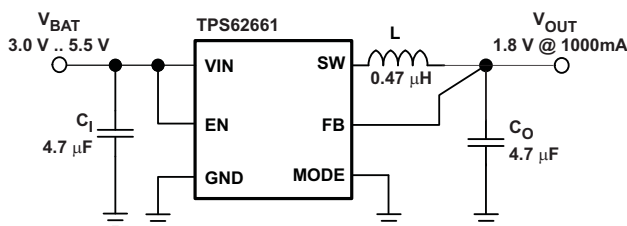
Figure 1. Smallest Solution Size Application

DESCRIPTION

The TPS6266x device is a high-frequency synchronous step-down dc-dc converter optimized for battery-powered portable applications. Intended for low-power applications, the TPS6266x supports up to 1000mA peak load current, and allows the use of low cost chip inductor and capacitors.

With a wide input voltage range of 2.3V to 5.5V, the device supports applications powered by Li-Ion batteries with extended voltage range. Different fixed voltage output versions are available from 1.2V to 2.3V.

The TPS6266x operates at a regulated 6-MHz switching frequency and enters the power-save mode operation at light load currents to maintain high efficiency over the entire load current range.

The PFM mode extends the battery life by reducing the quiescent current to 31 μ A (typ) during light load and standby operation. For noise-sensitive applications, the device can be forced into fixed frequency PWM mode by pulling the MODE pin high. In the shutdown mode, the current consumption is reduced to less than 1 μ A.

The TPS6266x is available in an 6-pin chip-scale package (CSP).

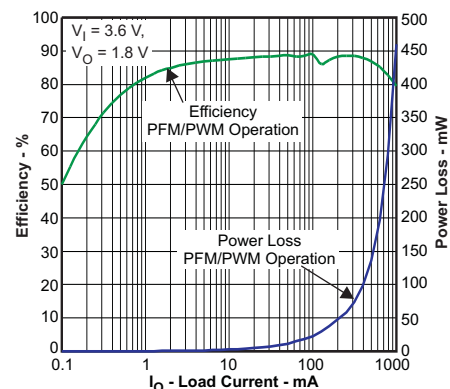
Figure 2. Efficiency vs Load Current

Please be aware that an important notice concerning availability, standard warranty, and use in critical applications of Texas Instruments semiconductor products and disclaimers thereto appears at the end of this data sheet.

NanoFree is a trademark of Texas Instruments.

PRODUCTION DATA information is current as of publication date. Products conform to specifications per the terms of the Texas Instruments standard warranty. Production processing does not necessarily include testing of all parameters.

Copyright © 2010–2011, Texas Instruments Incorporated



These devices have limited built-in ESD protection. The leads should be shorted together or the device placed in conductive foam during storage or handling to prevent electrostatic damage to the MOS gates.

ORDERING INFORMATION⁽¹⁾

| T _A | PART NUMBER | OUTPUT VOLTAGE | DEVICE SPECIFIC FEATURE | PACKAGE | ORDERING ^{(2) (3)} | PACKAGE MARKING CHIP CODE |
|----------------|-------------------------|----------------|----------------------------|---------|-----------------------------|---------------------------|
| -40°C to 85°C | TPS62660 | 1.8V | | YFF-6 | TPS62660YFF | OO |
| | TPS62661 ⁽⁴⁾ | 1.8V | Fast start-up time | | | |
| | TPS62665 | 1.2V | Output capacitor discharge | | TPS62665YFF | RS |

- (1) For the most current package and ordering information, see the Package Option Addendum at the end of this document, or see the TI website at www.ti.com.
- (2) The YFF package is available in tape and reel. Add an R suffix (TPS62660YFFR) to order quantities of 3000 parts. Add a T suffix (TPS62660YFFT) to order quantities of 250 parts.
- (3) Internal tap points are available to facilitate output voltages in 25mV increments.
- (4) Product preview.

ABSOLUTE MAXIMUM RATINGS

over operating free-air temperature range (unless otherwise noted)⁽¹⁾

| | | UNIT |
|---------------------------|--|----------------------------------|
| V _I | Voltage at VIN, SW ⁽²⁾ | -0.3 V to 7 V |
| | Voltage at FB ⁽²⁾ | -0.3 V to 3.6 V |
| | Voltage at EN, MODE ⁽²⁾ | -0.3 V to V _I + 0.3 V |
| I _O | Peak output current | 1000 mA |
| | Power dissipation | Internally limited |
| T _A | Operating temperature range ⁽³⁾ | -40°C to 85°C |
| T _J (max) | Maximum operating junction temperature | 150°C |
| T _{stg} | Storage temperature range | -65°C to 150°C |
| ESD rating ⁽⁴⁾ | Human body model | 2 kV |
| | Charge device model | 1 kV |
| | Machine model | 200 V |

- (1) Stresses beyond those listed under *absolute maximum ratings* may cause permanent damage to the device. These are stress ratings only and functional operation of the device at these or any other conditions beyond those indicated under *recommended operating conditions* is not implied. Exposure to absolute-maximum-rated conditions for extended periods may affect device reliability.
- (2) All voltage values are with respect to network ground terminal.
- (3) In applications where high power dissipation and/or poor package thermal resistance is present, the maximum ambient temperature may have to be derated. Maximum ambient temperature (T_{A(max)}) is dependent on the maximum operating junction temperature (T_{J(max)}), the maximum power dissipation of the device in the application (P_{D(max)}), and the junction-to-ambient thermal resistance of the part/package in the application (θ_{JA}), as given by the following equation: T_{A(max)} = T_{J(max)} - (θ_{JA} × P_{D(max)}). To achieve optimum performance, it is recommended to operate the device with a maximum junction temperature of 105°C.
- (4) The human body model is a 100-pF capacitor discharged through a 1.5-kΩ resistor into each pin. The machine model is a 200-pF capacitor discharged directly into each pin.

DISSIPATION RATINGS⁽¹⁾

| PACKAGE | R _{θJA} ⁽²⁾ | R _{θJB} ⁽²⁾ | POWER RATING T _A ≤ 25°C | DERATING FACTOR ABOVE T _A = 25°C |
|---------|---------------------------------|---------------------------------|---------------------------------------|--|
| YFF-6 | 125°C/W | 53°C/W | 800mW | 8mW/°C |

- (1) Maximum power dissipation is a function of T_{J(max)}, θ_{JA} and T_A. The maximum allowable power dissipation at any allowable ambient temperature is P_D = [T_{J(max)} - T_A] / θ_{JA}.
- (2) This thermal data is measured with high-K board (4 layers board according to JESD51-7 JEDEC standard).

ELECTRICAL CHARACTERISTICS

Minimum and maximum values are at $V_I = 2.3V$ to $5.5V$, $V_O = 1.8V$, $EN = 1.8V$, AUTO mode and $T_A = -40^\circ C$ to $85^\circ C$; Circuit of Parameter Measurement Information section (unless otherwise noted). Typical values are at $V_I = 3.6V$, $V_O = 1.8V$, $EN = 1.8V$, AUTO mode and $T_A = 25^\circ C$ (unless otherwise noted).

| PARAMETER | | TEST CONDITIONS | | MIN | TYP | MAX | UNIT |
|-----------------------|--|-----------------|---|-----------------------|-----------|-----------------------|------------------|
| SUPPLY CURRENT | | | | | | | |
| V_I | Input voltage range | | | 2.3 | | 5.5 | V |
| I_Q | Operating quiescent current | | $I_O = 0mA$, Device not switching | | 31 | 55 | μA |
| | | | $I_O = 0mA$, PWM mode | | 7.6 | | mA |
| $I_{(SD)}$ | Shutdown current | | $EN = GND$ | | 0.2 | 2.5 | μA |
| UVLO | Undervoltage lockout threshold | | | | 2.05 | 2.1 | V |
| ENABLE, MODE | | | | | | | |
| V_{IH} | High-level input voltage | | | 1.0 | | | V |
| V_{IL} | Low-level input voltage | | | | | 0.4 | V |
| I_{ikg} | Input leakage current | | Input connected to GND or VIN | | 0.01 | 1 | μA |
| POWER SWITCH | | | | | | | |
| $r_{DS(on)}$ | P-channel MOSFET on resistance | TPS6266x | $V_I = V_{(GS)} = 3.6V$, PWM mode | | 270 | | m Ω |
| | | | $V_I = V_{(GS)} = 2.5V$, PWM mode | | 350 | | m Ω |
| I_{ikg} | P-channel leakage current, PMOS | | $V_{(DS)} = 5.5V$, $-40^\circ C \leq T_J \leq 85^\circ C$ | | | 1 | μA |
| $r_{DS(on)}$ | N-channel MOSFET on resistance | TPS6266x | $V_I = V_{(GS)} = 3.6V$, PWM mode | | 140 | | m Ω |
| | | | $V_I = V_{(GS)} = 2.5V$, PWM mode | | 200 | | m Ω |
| I_{ikg} | N-channel leakage current, NMOS | | $V_{(DS)} = 5.5V$, $-40^\circ C \leq T_J \leq 85^\circ C$ | | | 2 | μA |
| r_{DIS} | Discharge resistor for power-down sequence | TPS62665 | | | 15 | 50 | Ω |
| | P-MOS current limit | | $2.3V \leq V_I \leq 4.8V$, Open loop | 1400 | 1500 | 1750 | mA |
| | Input current limit under short-circuit conditions | | V_O shorted to ground | | 19 | | mA |
| | Thermal shutdown | | | | 140 | | $^\circ C$ |
| | Thermal shutdown hysteresis | | | | 10 | | $^\circ C$ |
| OSCILLATOR | | | | | | | |
| f_{SW} | Oscillator frequency | TPS6266x | $I_O = 0mA$, PWM mode | 5.4 | 6 | 6.6 | MHz |
| OUTPUT | | | | | | | |
| $V_{(OUT)}$ | Regulated DC output voltage | TPS6266x | $2.3V \leq V_I \leq 2.7V$, $0mA \leq I_O \leq 600mA$ $2.7V \leq V_I \leq 3.0V$, $0mA \leq I_O \leq 800mA$ $3.0V \leq V_I \leq 4.8V$, $0mA \leq I_O \leq 1000mA$ PFM/PWM operation | $0.98 \times V_{NOM}$ | V_{NOM} | $1.03 \times V_{NOM}$ | V |
| | | | $3.0V \leq V_I \leq 5.5V$, $0mA \leq I_O \leq 1000mA$ PFM/PWM operation | $0.98 \times V_{NOM}$ | V_{NOM} | $1.04 \times V_{NOM}$ | V |
| | | | $2.3V \leq V_I \leq 2.7V$, $0mA \leq I_O \leq 600mA$ $2.7V \leq V_I \leq 3.0V$, $0mA \leq I_O \leq 800mA$ $3.0V \leq V_I \leq 5.5V$, $0mA \leq I_O \leq 1000mA$ PWM operation | $0.98 \times V_{NOM}$ | V_{NOM} | $1.02 \times V_{NOM}$ | V |
| | Line regulation | | $V_I = V_O + 0.5V$ (min 2.3V) to 5.5V, $I_O = 200mA$ | | 0.13 | | %/V |
| | Load regulation | | $V_I = 3.6V$, $I_O = 0mA$ to 1000mA | | -0.00025 | | %/mA |
| | Feedback input resistance | | | | 480 | | k Ω |
| ΔV_O | Power-save mode ripple voltage | TPS62660 | $I_O = 1mA$ | | 20 | | mV _{PP} |
| | | TPS62661 | $I_O = 1mA$ $L = 1\mu H$ (muRata LQM2MPN1R0NG0) $C_O = 10\mu F$ 4V 0402 (muRata GRM155R60G106M) | | 9 | | mV _{PP} |
| | | TPS62665 | $I_O = 1mA$ | | 24 | | mV _{PP} |
| Start-up time | | TPS62660 | $I_O = 0mA$, Time from active EN to V_O | | 120 | | μs |
| | | TPS62661 | $R_L = 2\Omega$, Time from active EN to V_O | | 55 | | μs |

PIN ASSIGNMENTS



PIN FUNCTIONS

| PIN | | I/O | DESCRIPTION |
|------|-----|-----|---|
| NAME | NO. | | |
| FB | C1 | I | Output feedback sense input. Connect FB to the converter's output. |
| VIN | A2 | I | Power supply input. |
| SW | B1 | I/O | This is the switch pin of the converter and is connected to the drain of the internal Power MOSFETs. |
| EN | B2 | I | This is the enable pin of the device. Connecting this pin to ground forces the device into shutdown mode. Pulling this pin to V_I enables the device. This pin must not be left floating and must be terminated. |
| MODE | A1 | I | This is the mode selection pin of the device. This pin must not be left floating and must be terminated. MODE = LOW: The device is operating in regulated frequency pulse width modulation mode (PWM) at high-load currents and in pulse frequency modulation mode (PFM) at light load currents. MODE = HIGH: Low-noise mode enabled, regulated frequency PWM operation forced. |
| GND | C2 | – | Ground pin. |

FUNCTIONAL BLOCK DIAGRAM

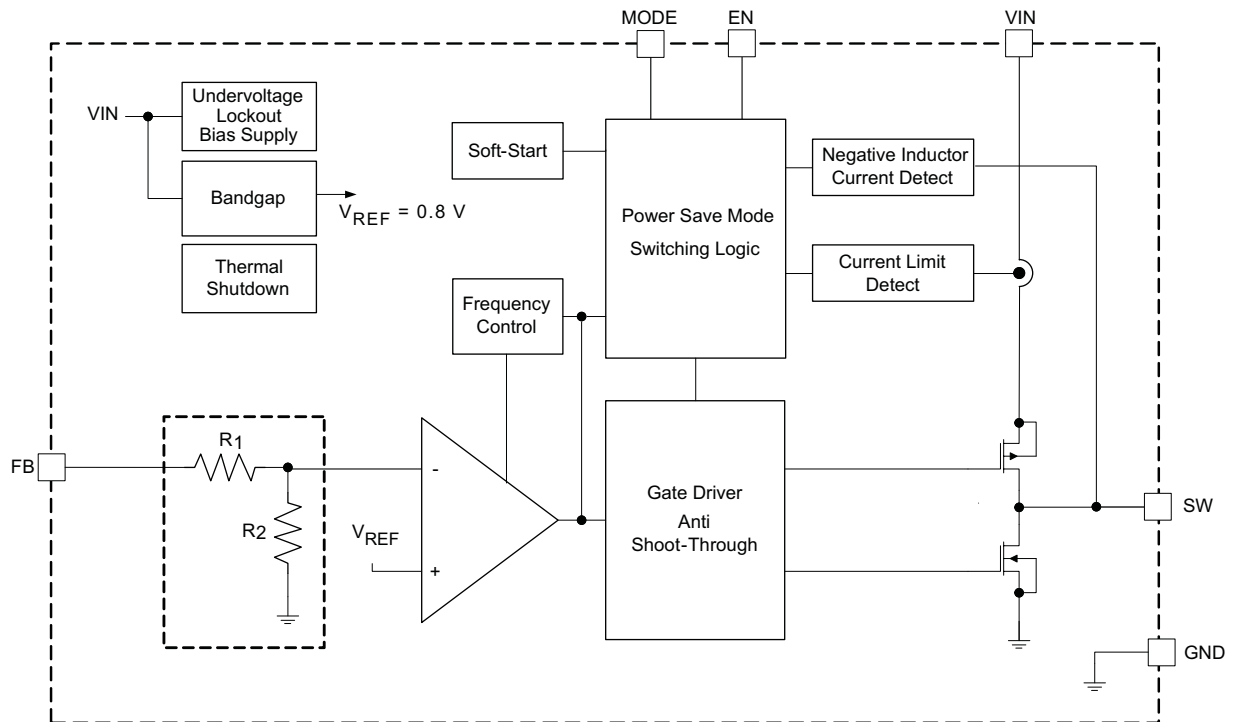

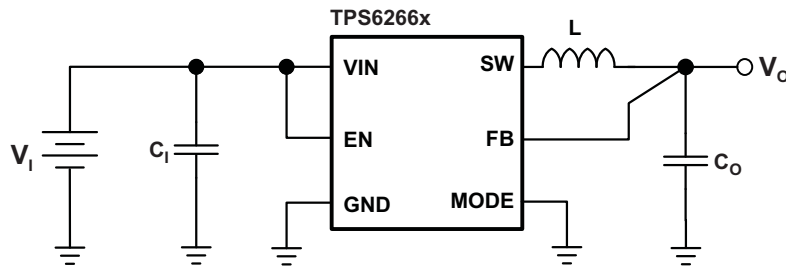
PARAMETER MEASUREMENT INFORMATION

List of components:

- L = MURATA LQM21PN1R0NGR
- C₁ = MURATA GRM155R60J475M (4.7μF, 6.3V, 0402, X5R)
- C_O = MURATA GRM155R60J475M (4.7μF, 6.3V, 0402, X5R)

TYPICAL CHARACTERISTICS

Table of Graphs

| | | | FIGURE |
|--------------|---------------------------------------|--------------------|--|
| η | Efficiency | vs Load current | 3, 4, 5, 6 |
| | | vs Input voltage | 7 |
| | Peak-to-peak output ripple current | vs Load current | 8, 9 |
| | Combined line/load transient response | | 10, 11 |
| | Load transient response | | 12, 13, 14, 15, 16, 17, 18, 19, 20, 21, 22 |
| | AC load transient response | | 23, 24, 25 |
| V_O | DC output voltage | vs Load current | 26, 27 |
| | | PFM/PWM boundaries | 28, 29 |
| I_Q | No load quiescent current | vs Input voltage | 30 |
| f_s | Switching frequency | vs Input voltage | 31 |
| $r_{DS(on)}$ | P-channel MOSFET $r_{DS(on)}$ | vs Input voltage | 32 |
| | N-channel MOSFET $r_{DS(on)}$ | vs Input voltage | 33 |
| | PWM operation | | 34 |
| | Power-save mode operation | | 35 |
| | Mode change response | | 36, 37 |
| | Over-current fault operation | | 38 |
| | Start-up | | 39, 40 |

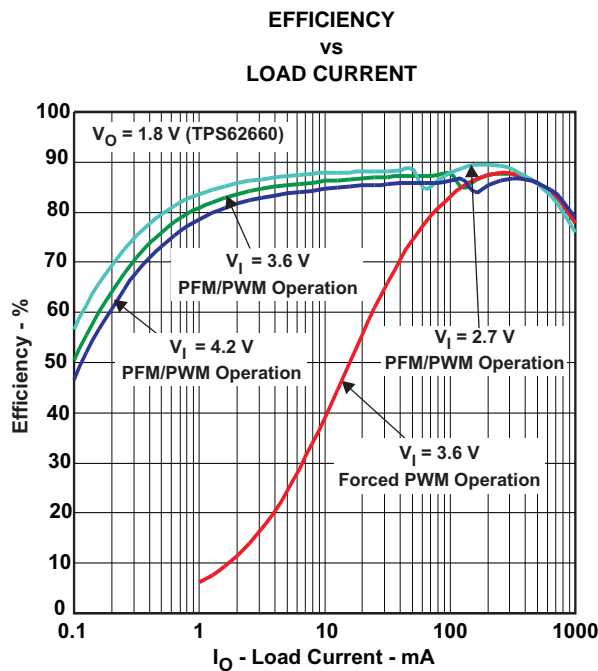

Figure 3.

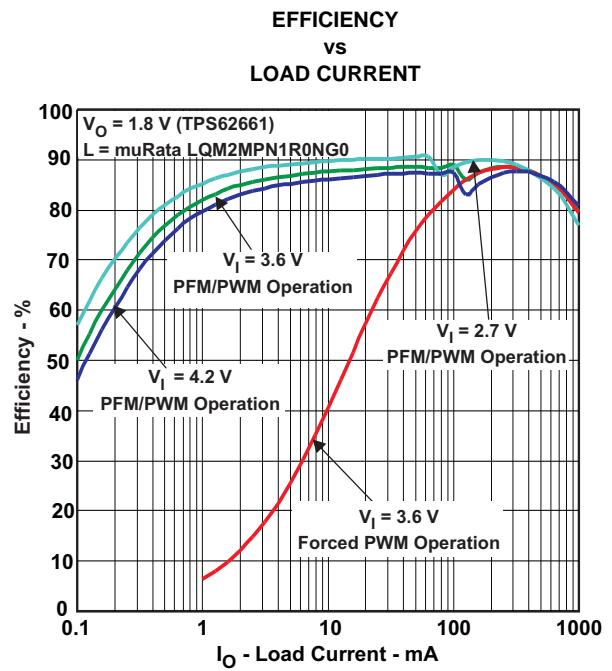

Figure 4.

TYPICAL CHARACTERISTICS (continued)

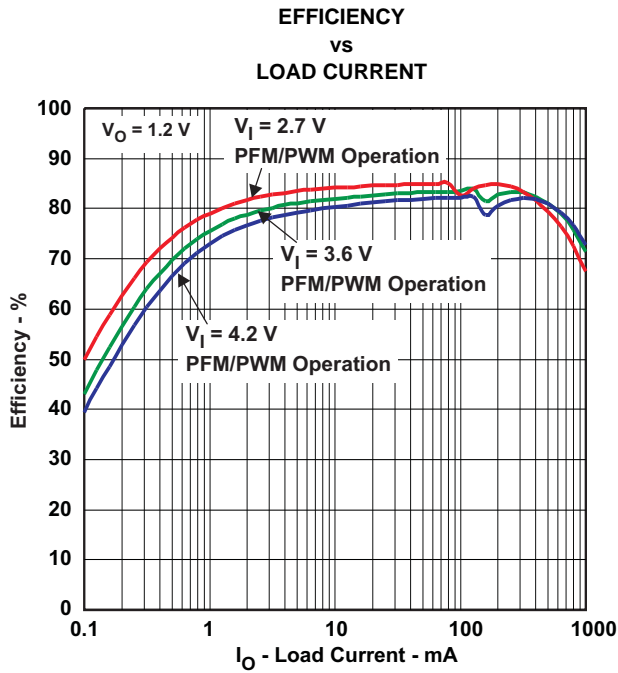

Figure 5.

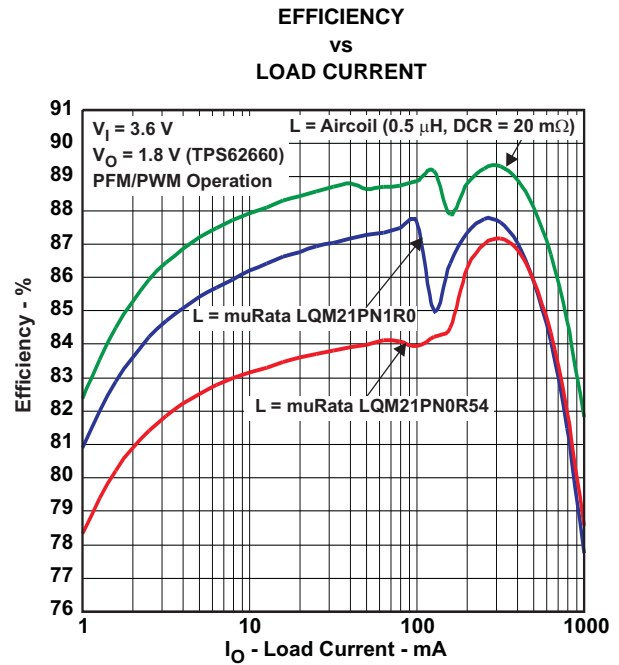

Figure 6.

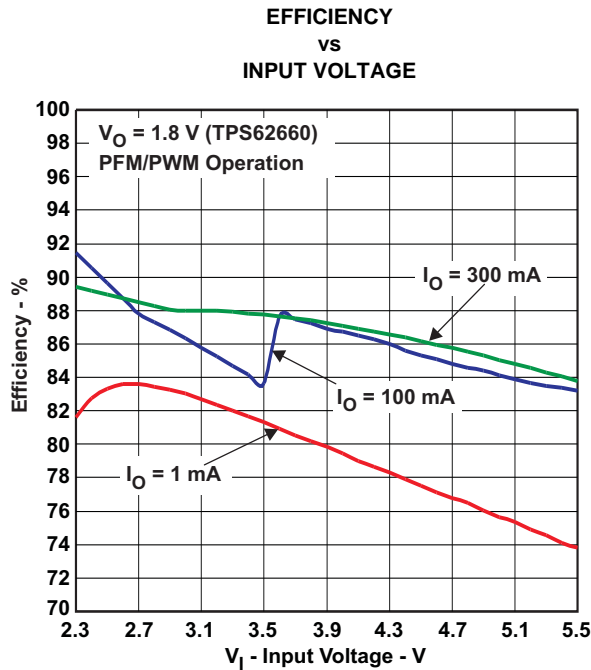

Figure 7.

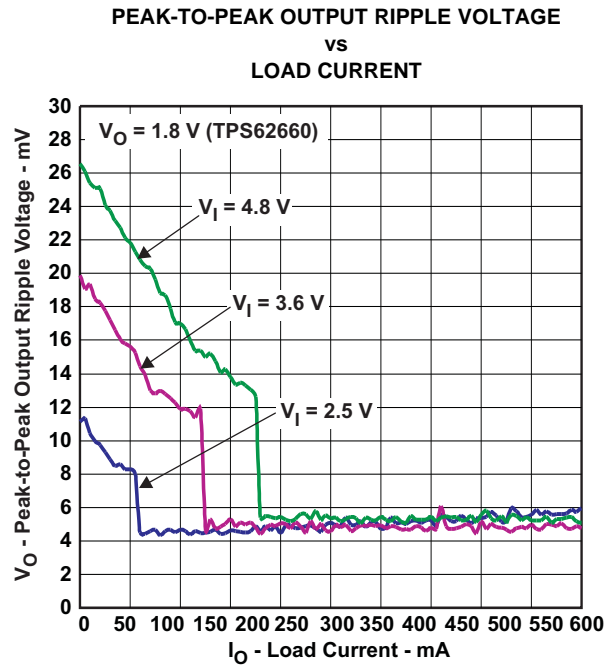

Figure 8.

TYPICAL CHARACTERISTICS (continued)

**PEAK-TO-PEAK OUTPUT RIPPLE VOLTAGE
vs
LOAD CURRENT**

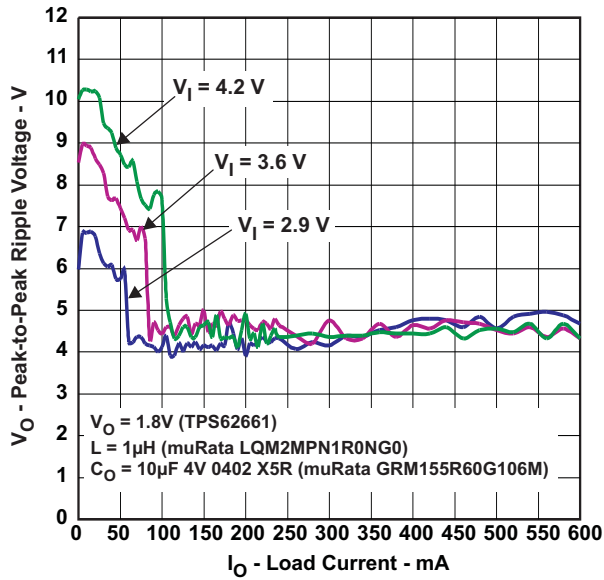

Figure 9.

COMBINED LINE/LOAD TRANSIENT RESPONSE

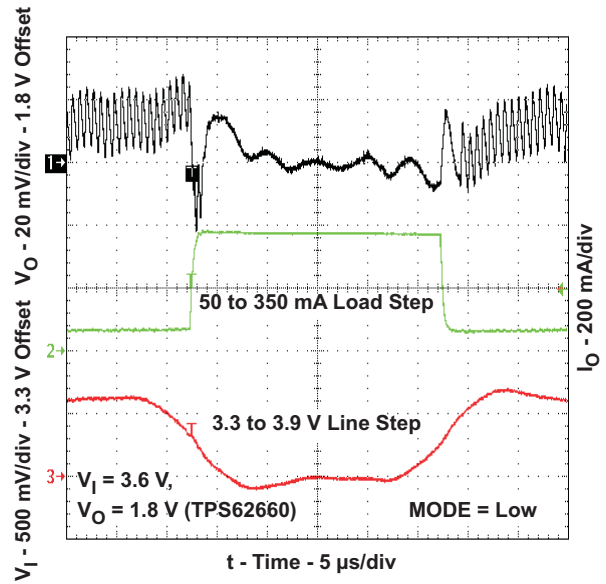

Figure 10.

COMBINED LINE/LOAD TRANSIENT RESPONSE

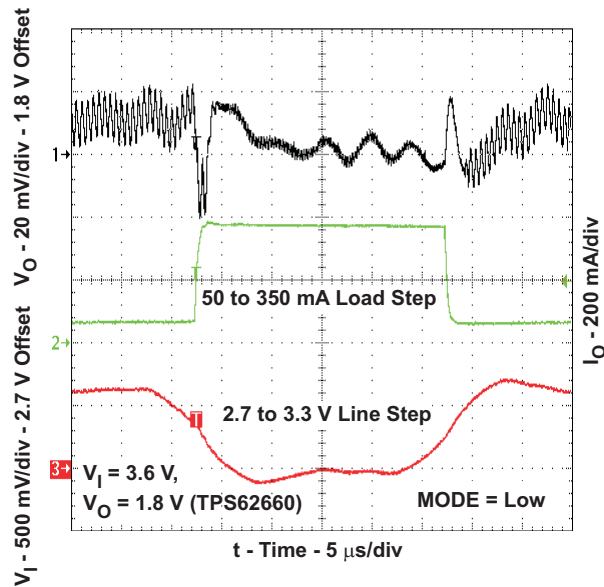

Figure 11.

**LOAD TRANSIENT RESPONSE IN
PFM/PWM OPERATION**

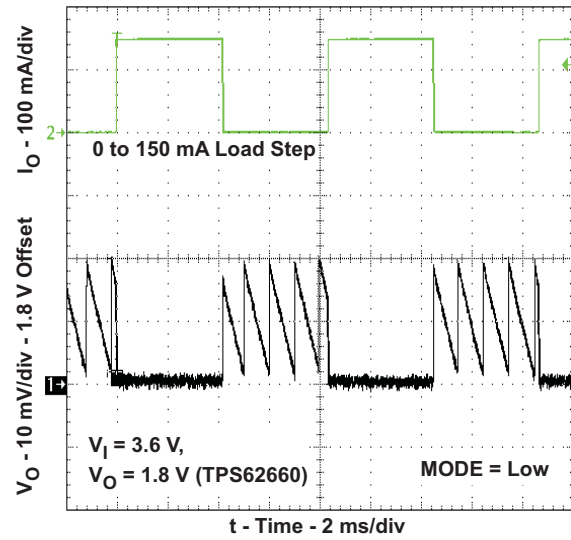

Figure 12.

TYPICAL CHARACTERISTICS (continued)

LOAD TRANSIENT RESPONSE IN PFM/PWM OPERATION

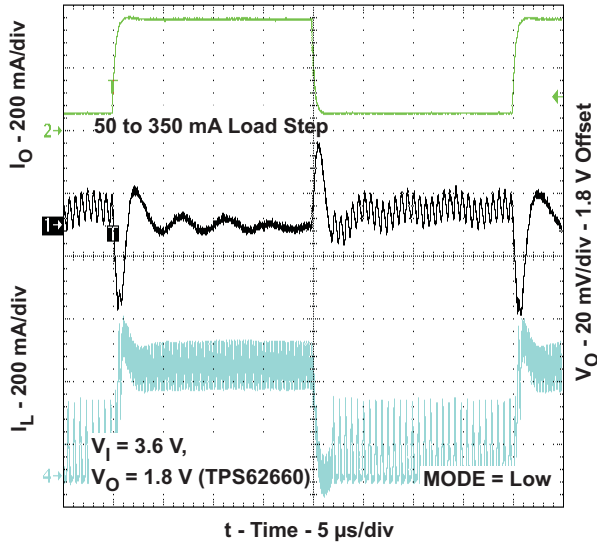

Figure 13.

LOAD TRANSIENT RESPONSE IN PFM/PWM OPERATION

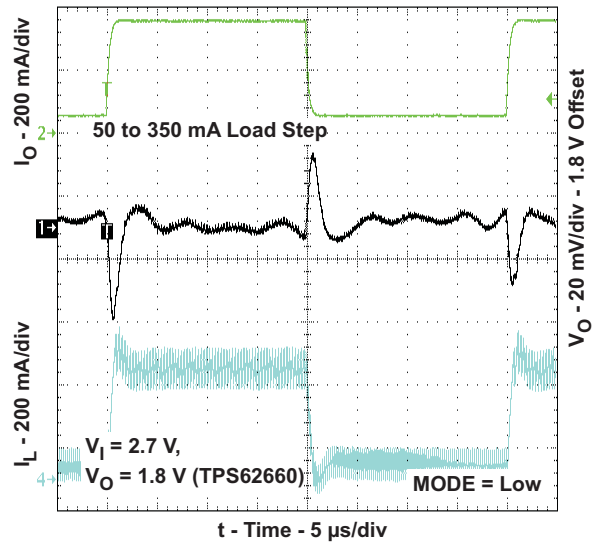

Figure 14.

LOAD TRANSIENT RESPONSE IN PFM/PWM OPERATION

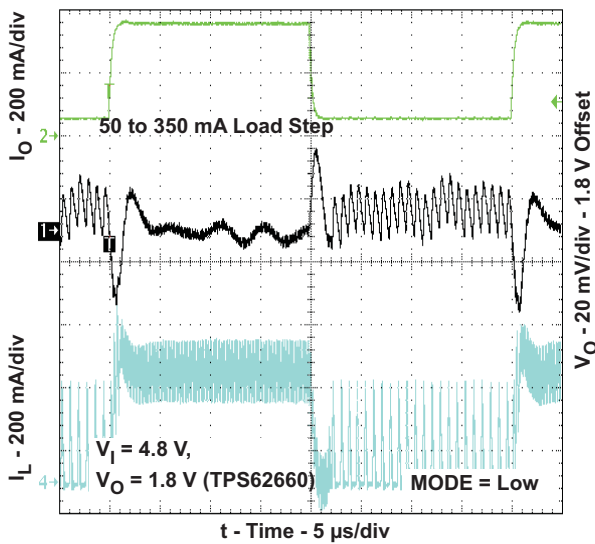

Figure 15.

LOAD TRANSIENT RESPONSE IN PFM/PWM OPERATION

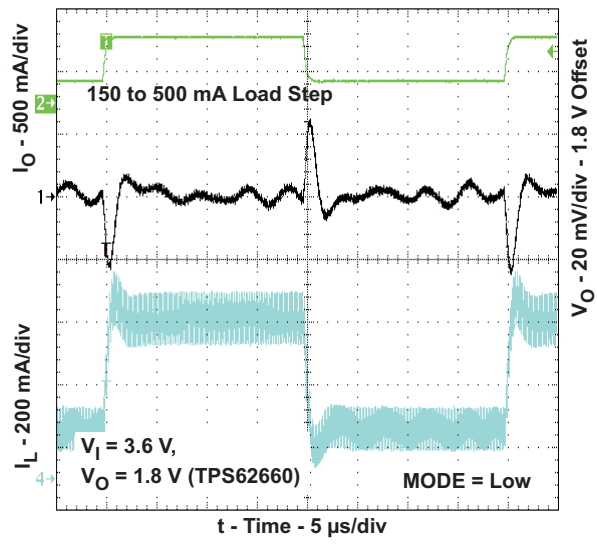

Figure 16.

TYPICAL CHARACTERISTICS (continued)

LOAD TRANSIENT RESPONSE IN PFM/PWM OPERATION

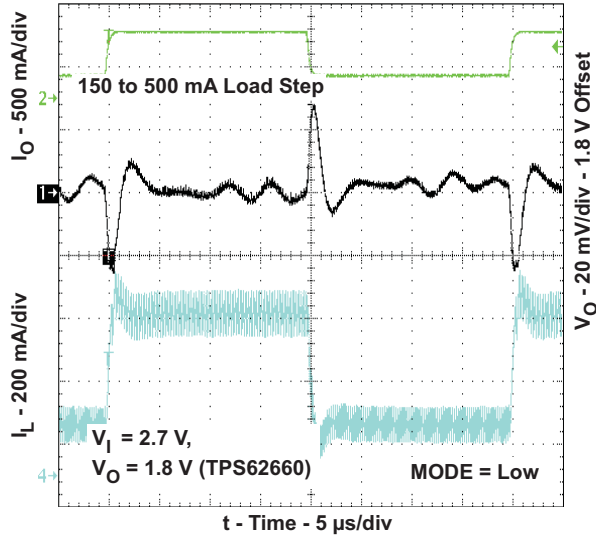

Figure 17.

LOAD TRANSIENT RESPONSE IN PFM/PWM OPERATION

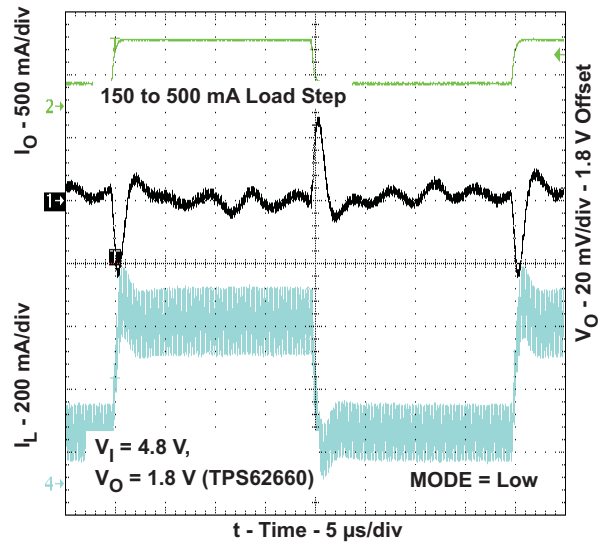

Figure 18.

LOAD TRANSIENT RESPONSE IN PFM/PWM OPERATION

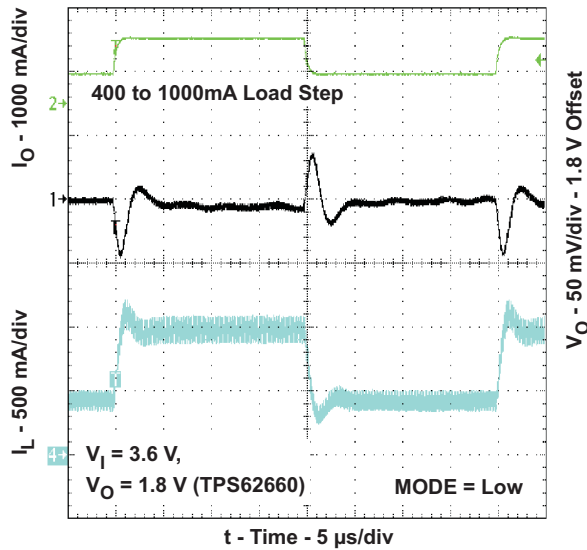

Figure 19.

LOAD TRANSIENT RESPONSE IN PFM/PWM OPERATION

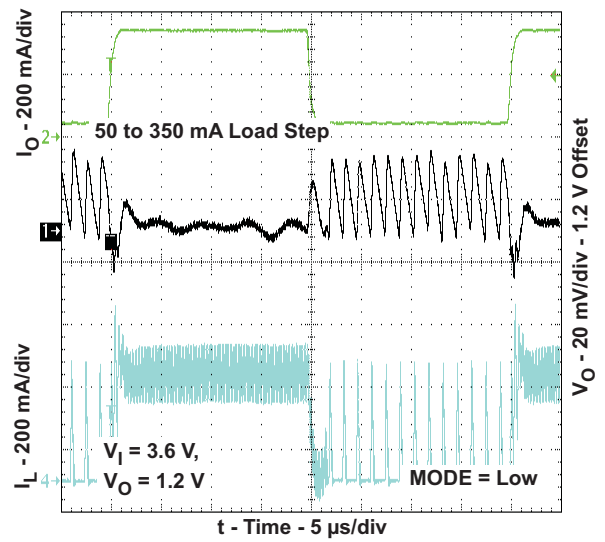

Figure 20.

TYPICAL CHARACTERISTICS (continued)

LOAD TRANSIENT RESPONSE
IN PFM/PWM OPERATION

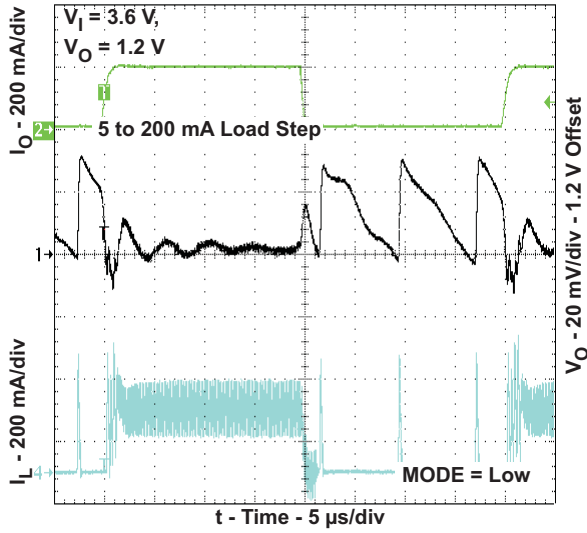

Figure 21.

LOAD TRANSIENT RESPONSE
IN PFM/PWM OPERATION

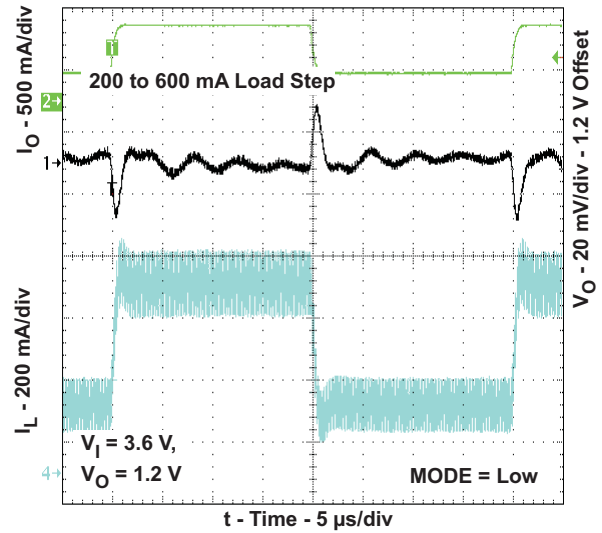

Figure 22.

AC LOAD TRANSIENT RESPONSE

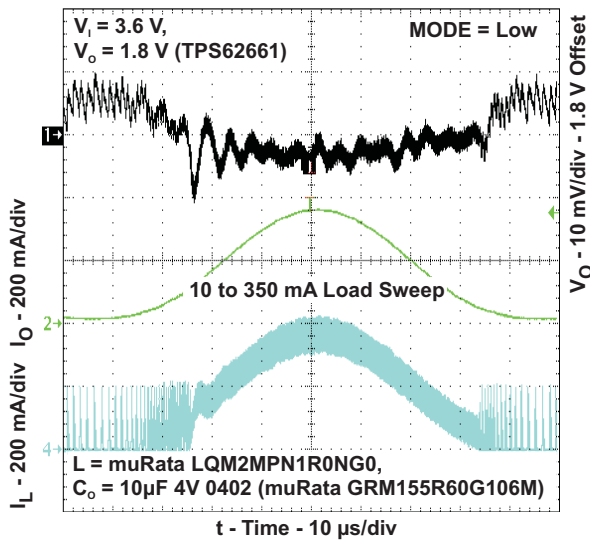

Figure 23.

AC LOAD TRANSIENT RESPONSE

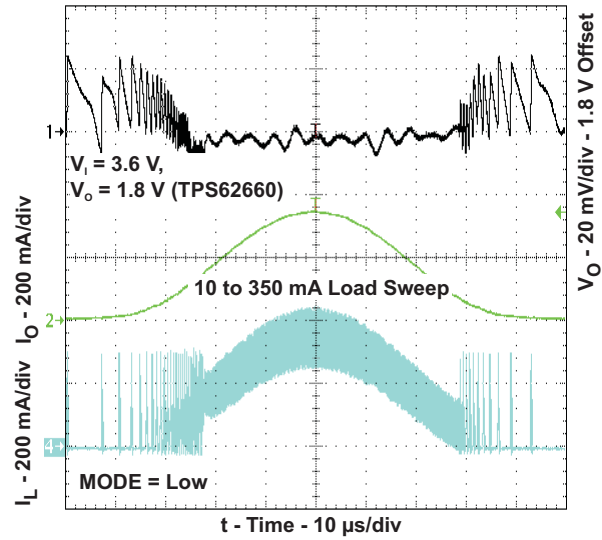

Figure 24.

TYPICAL CHARACTERISTICS (continued)

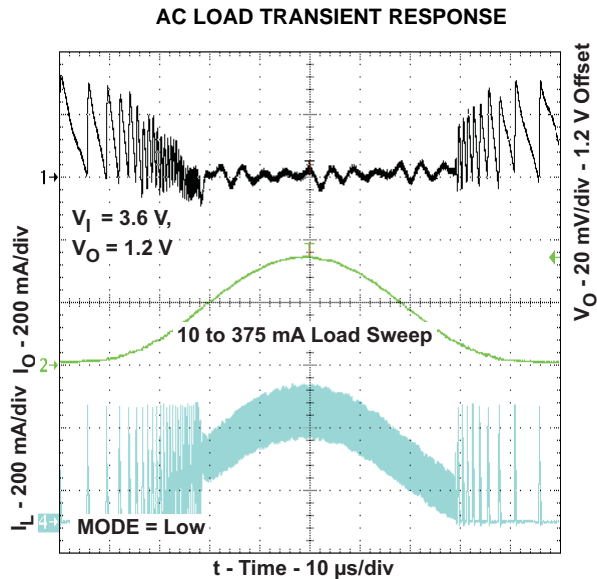

Figure 25.

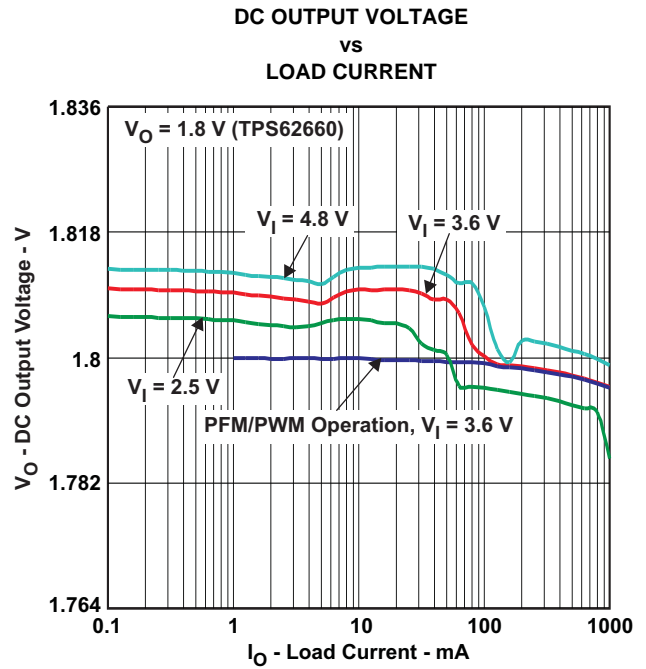

Figure 26.

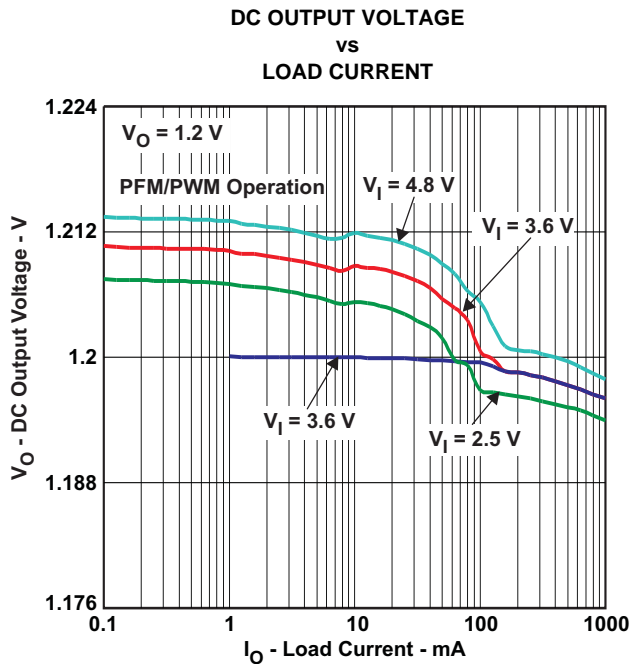

Figure 27.

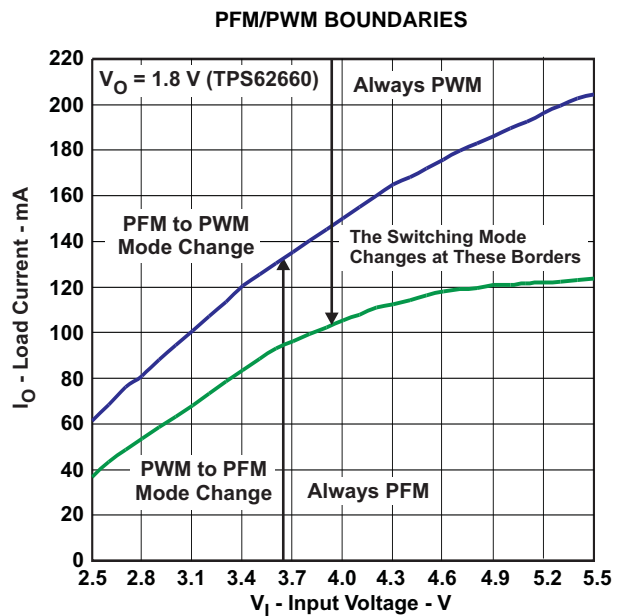

Figure 28.

TYPICAL CHARACTERISTICS (continued)

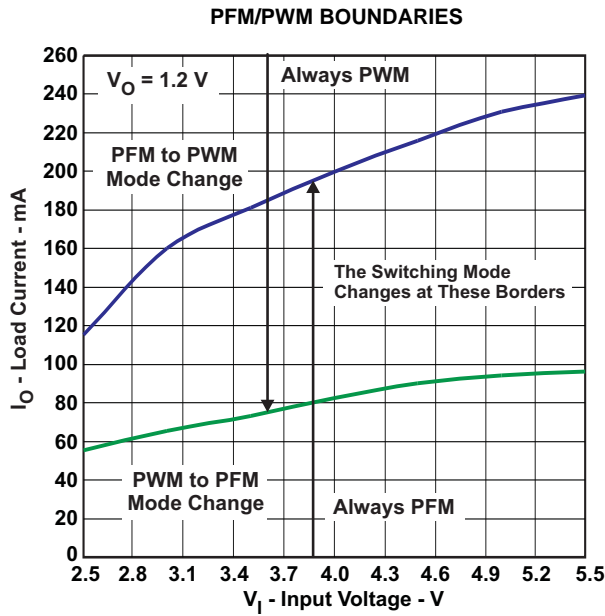

Figure 29.

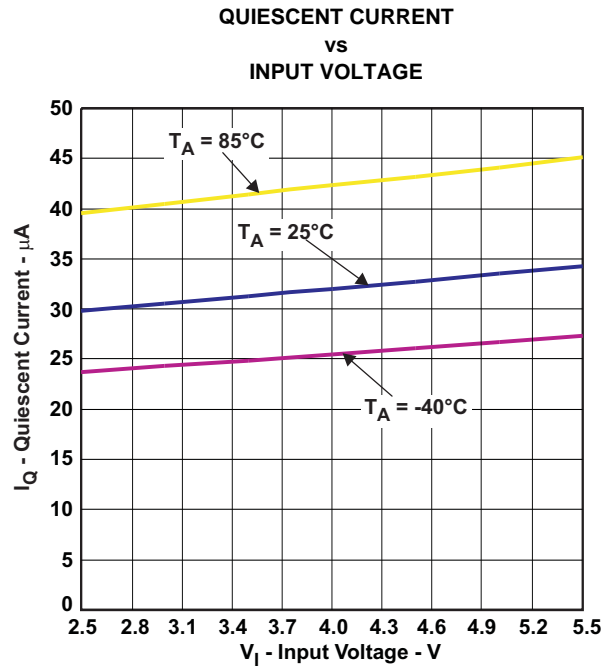

Figure 30.

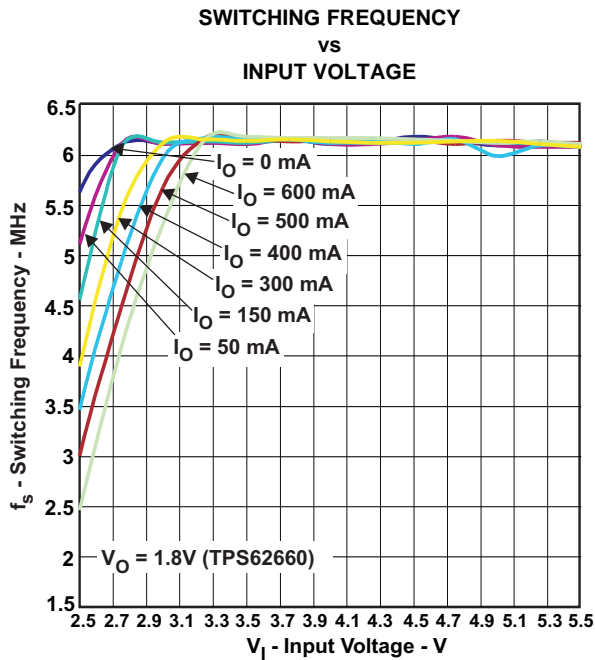

Figure 31.

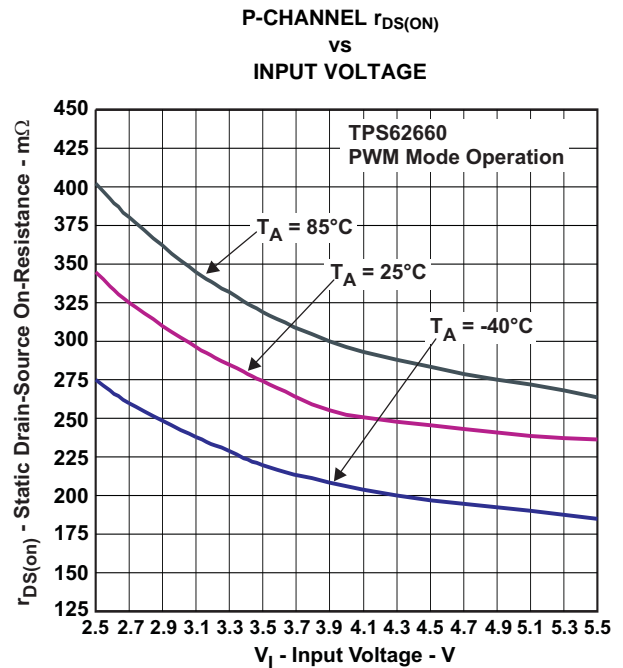

Figure 32.

TYPICAL CHARACTERISTICS (continued)

**N-CHANNEL $r_{DS(on)}$
vs
INPUT VOLTAGE**

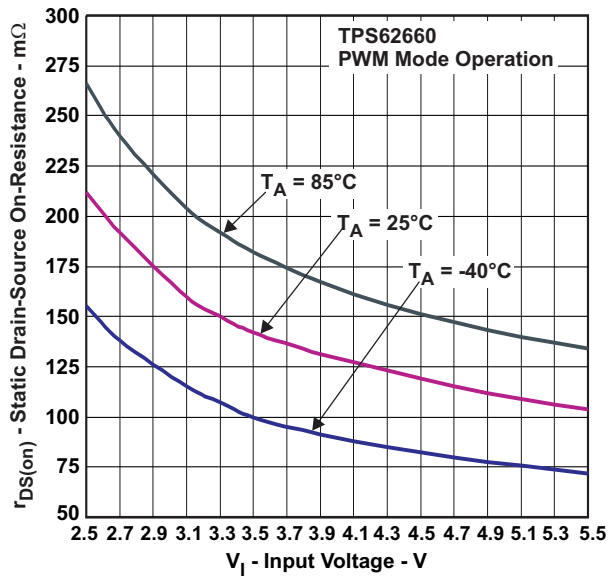

Figure 33.

PWM OPERATION

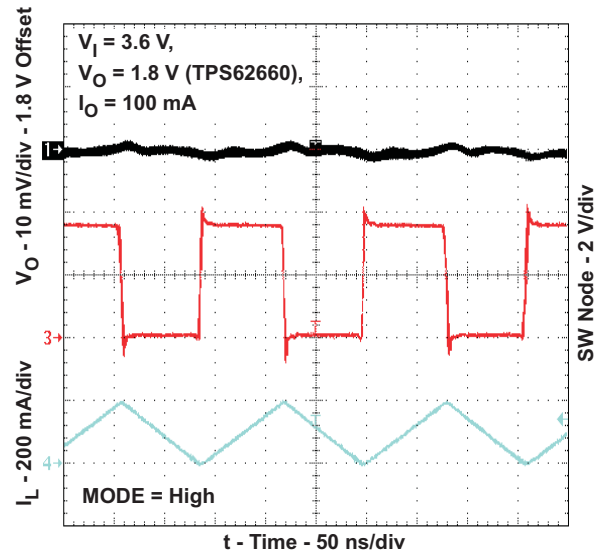

Figure 34.

POWER-SAVE MODE OPERATION

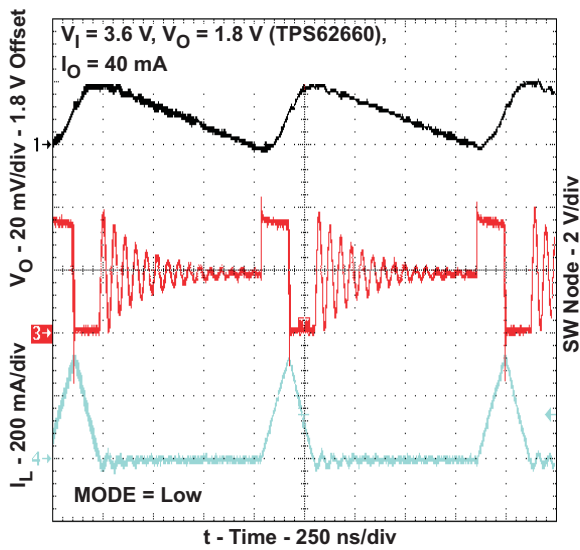

Figure 35.

MODE CHANGE RESPONSE

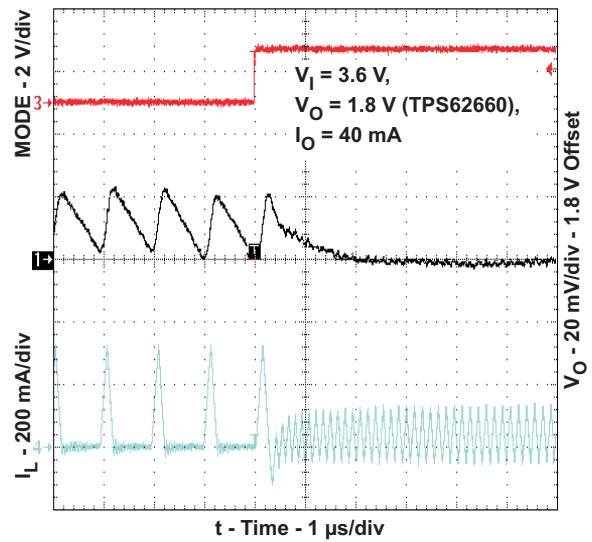

Figure 36.

TYPICAL CHARACTERISTICS (continued)

MODE CHANGE RESPONSE

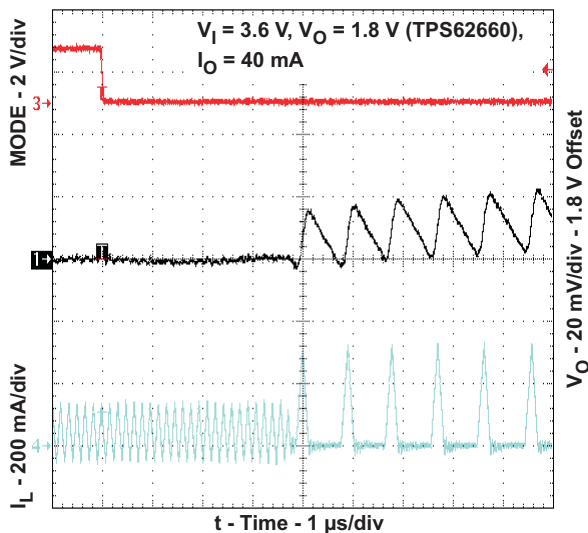

Figure 37.

OVER-CURRENT FAULT OPERATION

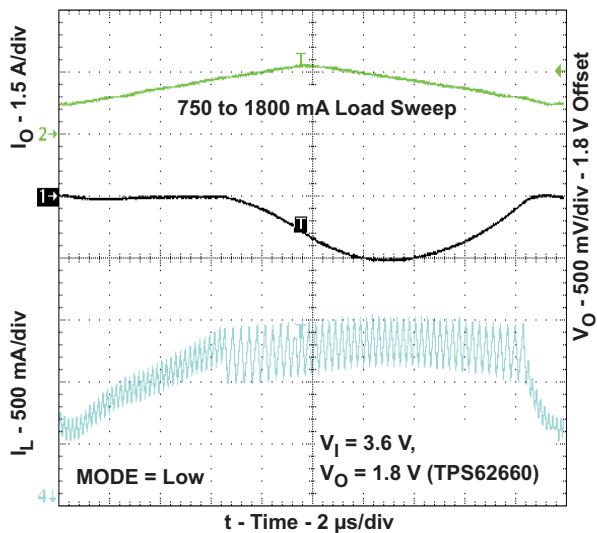

Figure 38.

START-UP

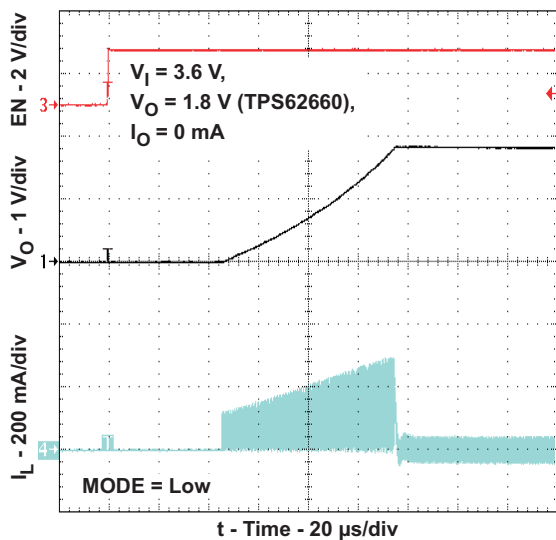

Figure 39.

START-UP

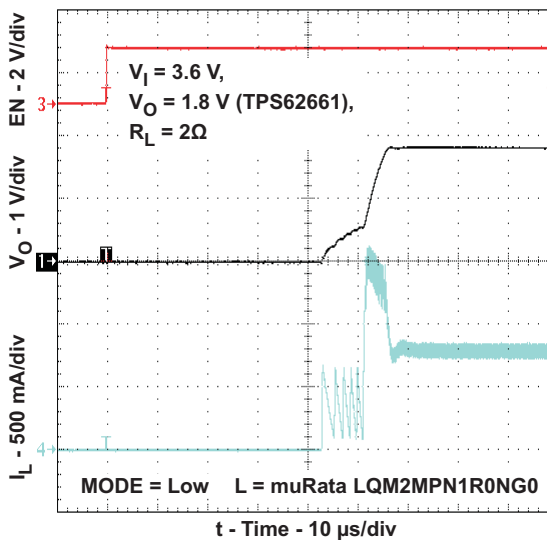

Figure 40.

DETAILED DESCRIPTION

OPERATION

The TPS6266x is a synchronous step-down converter typically operates at a regulated 6-MHz frequency pulse width modulation (PWM) at moderate to heavy load currents. At light load currents, the TPS6266x converter operates in power-save mode with pulse frequency modulation (PFM).

The converter uses a unique frequency locked ring oscillating modulator to achieve *best-in-class* load and line response and allows the use of tiny inductors and small ceramic input and output capacitors. At the beginning of each switching cycle, the P-channel MOSFET switch is turned on and the inductor current ramps up rising the output voltage until the main comparator trips, then the control logic turns off the switch.

One key advantage of the non-linear architecture is that there is no traditional feed-back loop. The loop response to change in V_O is essentially instantaneous, which explains the transient response. The absence of a traditional, high-gain compensated linear loop means that the TPS6266x is inherently stable over a range of L and C_O .

Although this type of operation normally results in a switching frequency that varies with input voltage and load current, an internal frequency lock loop (FLL) holds the switching frequency constant over a large range of operating conditions.

Combined with *best in class* load and line transient response characteristics, the low quiescent current of the device (ca. 31 μ A) allows to maintain high efficiency at light load, while preserving fast transient response for applications requiring tight output regulation.

SWITCHING FREQUENCY

The magnitude of the internal ramp, which is generated from the duty cycle, reduces for duty cycles either set of 50%. Thus, there is less overdrive on the main comparator inputs which tends to slow the conversion down. The intrinsic maximum operating frequency of the converter is about 10MHz to 12MHz, which is controlled to circa. 6MHz by a frequency locked loop.

When high or low duty cycles are encountered, the loop runs out of range and the conversion frequency falls below 6MHz. The tendency is for the converter to operate more towards a "constant inductor peak current" rather than a "constant frequency". In addition to this behavior which is observed at high duty cycles, it is also noted at low duty cycles.

When the converter is required to operate towards the 6MHz nominal at extreme duty cycles, the application can be assisted by decreasing the ratio of inductance (L) to the output capacitor's equivalent serial inductance (ESL). This increases the *ESL step* seen at the main comparator's feed-back input thus decreasing its propagation delay, hence increasing the switching frequency.

POWER-SAVE MODE

If the load current decreases, the converter will enter Power Save Mode operation automatically. During power-save mode the converter operates in discontinuous current (DCM) single-pulse PFM mode, which produces low output ripple compared with other PFM architectures.

When in power-save mode, the converter resumes its operation when the output voltage trips below the nominal voltage. It ramps up the output voltage with a minimum of one pulse and goes into power-save mode when the inductor current has returned to a zero steady state. The PFM on-time varies inversely proportional to the input voltage and proportional to the output voltage giving the regulated switching frequency when in steady-state.

PFM mode is left and PWM operation is entered as the output current can no longer be supported in PFM mode. As a consequence, the DC output voltage is typically positioned ca. 0.5% above the nominal output voltage and the transition between PFM and PWM is seamless.

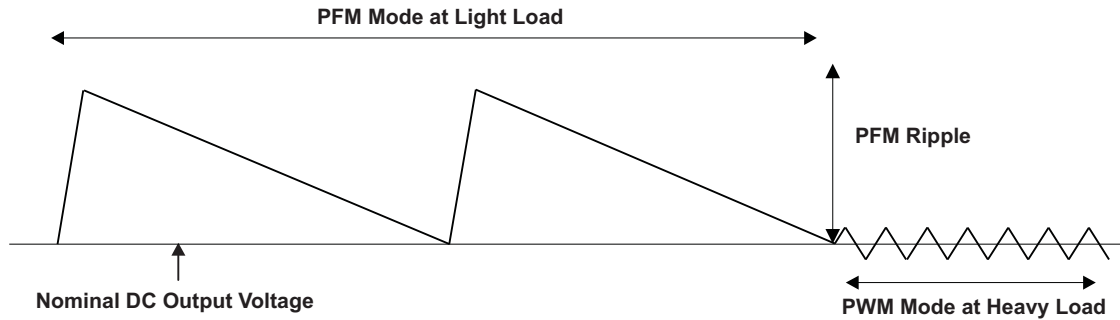

Figure 41. Operation in PFM Mode and Transfer to PWM Mode

MODE SELECTION

The MODE pin allows to select the operating mode of the device. Connecting this pin to GND enables the automatic PWM and power-save mode operation. The converter operates in regulated frequency PWM mode at moderate to heavy loads and in the PFM mode during light loads, which maintains high efficiency over a wide load current range.

Pulling the MODE pin high forces the converter to operate in the PWM mode even at light load currents. The advantage is that the converter operates with a fixed frequency that allows simple filtering of the switching frequency for noise-sensitive applications. In this mode, the efficiency is lower compared to the power-save mode during light loads.

For additional flexibility, it is possible to switch from power-save mode to forced PWM mode during operation. This allows efficient power management by adjusting the operation of the converter to the specific system requirements.

ENABLE

The device starts operation when EN is set high and starts up with the soft start as previously described. For proper operation, the EN pin must be terminated and must not be left floating.

Pulling the EN pin low forces the device into shutdown, with a shutdown quiescent current of typically 0.1 μ A. In this mode, the P and N-channel MOSFETs are turned off, the internal resistor feedback divider is disconnected, and the entire internal-control circuitry is switched off.

SOFT START

The TPS62660/62 has an internal soft-start circuit that limits the inrush current during start-up. This limits input voltage drops when a battery or a high-impedance power source is connected to the input of the converter.

The soft-start system progressively increases the on-time from a minimum pulse-width of 35ns as a function of the output voltage. This mode of operation continues for c.a. 100 μ s after enable. Should the output voltage not have reached its target value by this time, such as in the case of heavy load, the soft-start transitions to a second mode of operation.

The converter then operates in a current limit mode, specifically the P-MOS current limit is set to half the nominal limit, and the N-channel MOSFET remains on until the inductor current has reset. After a further 100 μ s, the device ramps up to the full current limit operation if the output voltage has risen above 0.5V (approximately). Therefore, the start-up time mainly depends on the output capacitor and load current.

The TPS62661 device starts-up immediately into a nominal current limit mode thereby ramping-up the output voltage with maximum speed (<60 μ s typ.). The start-up time mainly depends on the output capacitor and load current.

OUTPUT CAPACITOR DISCHARGE

The TPS6266x device can actively discharge the output capacitor when it turns off. The integrated discharge resistor has a typical resistance of 15 Ω . The required time to discharge the output capacitor at the output node depends on load current and the output capacitance value.

UNDERVOLTAGE LOCKOUT

The undervoltage lockout circuit prevents the device from misoperation at low input voltages. It prevents the converter from turning on the switch or rectifier MOSFET under undefined conditions. The TPS6266x device have a UVLO threshold set to 2.05V (typical). Fully functional operation is permitted down to 2.1V input voltage.

SHORT-CIRCUIT PROTECTION

The TPS6266x integrates a P-channel MOSFET current limit to protect the device against heavy load or short circuits. When the current in the P-channel MOSFET reaches its current limit, the P-channel MOSFET is turned off and the N-channel MOSFET is turned on. The regulator continues to limit the current on a cycle-by-cycle basis.

As soon as the output voltage falls below ca. 0.4V, the converter current limit is reduced to half of the nominal value. Because the short-circuit protection is enabled during start-up, the device does not deliver more than half of its nominal current limit until the output voltage exceeds approximately 0.5V. This needs to be considered when a load acting as a current sink is connected to the output of the converter.

THERMAL SHUTDOWN

As soon as the junction temperature, T_J , exceeds typically 140°C, the device goes into thermal shutdown. In this mode, the P- and N-channel MOSFETs are turned off. The device continues its operation when the junction temperature again falls below typically 130°C.

APPLICATION INFORMATION

INDUCTOR SELECTION

The TPS62660 series of step-down converters have been optimized to operate with an effective inductance value in the range of 0.3µH to 1.3µH and with output capacitors in the range of 4.7µF to 10µF. The internal compensation is optimized to operate with an output filter of $L = 0.47\mu\text{H}$ and $C_O = 4.7\mu\text{F}$. Larger or smaller inductor values can be used to optimize the performance of the device for specific operation conditions. For more details, see the *CHECKING LOOP STABILITY* section.

The inductor value affects its peak-to-peak ripple current, the PWM-to-PFM transition point, the output voltage ripple and the efficiency. The selected inductor has to be rated for its dc resistance and saturation current. The inductor ripple current (ΔI_L) decreases with higher inductance and increases with higher V_I or V_O .

$$\Delta I_L = \frac{V_O}{V_I} \times \frac{V_I - V_O}{L \times f_{sw}} \quad \Delta I_{L(\text{MAX})} = I_{O(\text{MAX})} + \frac{\Delta I_L}{2} \quad (1)$$

with: f_{sw} = switching frequency (6 MHz typical)

L = inductor value

ΔI_L = peak-to-peak inductor ripple current

$I_{L(\text{MAX})}$ = maximum inductor current

In high-frequency converter applications, the efficiency is essentially affected by the inductor AC resistance (i.e. quality factor) and to a smaller extent by the inductor DCR value. To achieve high efficiency operation, care should be taken in selecting inductors featuring a quality factor above 25 at the switching frequency. Increasing the inductor value produces lower RMS currents, but degrades transient response. For a given physical inductor size, increased inductance usually results in an inductor with lower saturation current.

The total losses of the coil consist of both the losses in the DC resistance ($R_{(DC)}$) and the following frequency-dependent components:

- The losses in the core material (magnetic hysteresis loss, especially at high switching frequencies)
- Additional losses in the conductor from the skin effect (current displacement at high frequencies)
- Magnetic field losses of the neighboring windings (proximity effect)
- Radiation losses

The following inductor series from different suppliers have been used with the TPS62660 converters.

Table 1. List of Inductors

| MANUFACTURER | SERIES | DIMENSIONS |
|--------------|------------------------|-----------------------------|
| MURATA | LQM21PN1R0NGR | 2.0 x 1.2 x 1.0 max. height |
| | LQM21PNR54MGC | 2.0 x 1.2 x 1.0 max. height |
| | LQM2MPN1R0NG0 | 2.0 x 1.6 x 1.0 max. height |
| PANASONIC | ELGTEAR82NA | 2.0 x 1.2 x 1.0 max. height |
| TOKO | MDT2012-CX1R0A | 2.0 x 1.2 x 1.0 max. height |
| TAIYO YUDEN | NM2012NR82, NM2012N1R0 | 2.0 x 1.2 x 1.0 max. height |
| FDK | MIPS2012D1R0-X2 | 2.0 x 1.2 x 1.0 max. height |

OUTPUT CAPACITOR SELECTION

The advanced fast-response voltage mode control scheme of the TPS6266x allows the use of tiny ceramic capacitors. Ceramic capacitors with low ESR values have the lowest output voltage ripple and are recommended. For best performance, the device should be operated with a minimum effective output capacitance of 1.6 μ F. The output capacitor requires either an X7R or X5R dielectric. Y5V and Z5U dielectric capacitors, aside from their wide variation in capacitance over temperature, become resistive at high frequencies.

At nominal load current, the device operates in PWM mode and the overall output voltage ripple is the sum of the voltage step caused by the output capacitor ESL and the ripple current flowing through the output capacitor impedance.

At light loads, the output capacitor limits the output ripple voltage and provides holdup during large load transitions. A 4.7 μ F capacitor typically provides sufficient bulk capacitance to stabilize the output during large load transitions. The typical output voltage ripple is 1% of the nominal output voltage V_O .

The output voltage ripple during PFM mode operation can be kept very small. The PFM pulse is time controlled, which allows to modify the charge transferred to the output capacitor by the value of the inductor. The resulting PFM output voltage ripple and PFM frequency depend in first order on the size of the output capacitor and the inductor value. The PFM frequency decreases with smaller inductor values and increases with larger one. Increasing the output capacitor value and the effective inductance will minimize the output ripple voltage.

INPUT CAPACITOR SELECTION

Because of the nature of the buck converter having a pulsating input current, a low ESR input capacitor is required to prevent large voltage transients that can cause misbehavior of the device or interferences with other circuits in the system. For most applications, a 4.7- μ F capacitor is sufficient. If the application exhibits a noisy or erratic switching frequency, the remedy will probably be found by experimenting with the value of the input capacitor.

Take care when using only ceramic input capacitors. When a ceramic capacitor is used at the input and the power is being supplied through long wires, such as from a wall adapter, a load step at the output can induce ringing at the VIN pin. This ringing can couple to the output and be mistaken as loop instability or could even damage the part. Additional "bulk" capacitance (electrolytic or tantalum) should in this circumstance be placed between C_I and the power source lead to reduce ringing than can occur between the inductance of the power source leads and C_I .

CHECKING LOOP STABILITY

The first step of circuit and stability evaluation is to look from a steady-state perspective at the following signals:

- Switching node, SW
- Inductor current, I_L
- Output ripple voltage, $V_{O(AC)}$

These are the basic signals that need to be measured when evaluating a switching converter. When the switching waveform shows large duty cycle jitter or the output voltage or inductor current shows oscillations, the regulation loop may be unstable. This is often a result of board layout and/or L-C combination.

As a next step in the evaluation of the regulation loop, the load transient response is tested. The time between the application of the load transient and the turn on of the P-channel MOSFET, the output capacitor must supply all of the current required by the load. V_O immediately shifts by an amount equal to $\Delta I_{(LOAD)} \times ESR$, where ESR is the effective series resistance of C_O . $\Delta I_{(LOAD)}$ begins to charge or discharge C_O generating a feedback error signal used by the regulator to return V_O to its steady-state value. The results are most easily interpreted when the device operates in PWM mode.

During this recovery time, V_O can be monitored for settling time, overshoot or ringing that helps judge the converter's stability. Without any ringing, the loop has usually more than 45° of phase margin.

Because the damping factor of the circuitry is directly related to several resistive parameters (e.g., MOSFET $r_{DS(on)}$) that are temperature dependant, the loop stability analysis has to be done over the input voltage range, load current range, and temperature range.

LAYOUT CONSIDERATIONS

As for all switching power supplies, the layout is an important step in the design. High-speed operation of the TPS6266x devices demand careful attention to PCB layout. Care must be taken in board layout to get the specified performance. If the layout is not carefully done, the regulator could show poor line and/or load regulation, stability and switching frequency issues as well as EMI problems. It is critical to provide a low inductance, impedance ground path. Therefore, use wide and short traces for the main current paths.

The input capacitor should be placed as close as possible to the IC pins as well as the inductor and output capacitor. In order to get an optimum *ESL step*, the output voltage feedback point (FB) should be taken in the output capacitor path, approximately 1mm away for it. The feed-back line should be routed away from noisy components and traces (e.g. SW line).

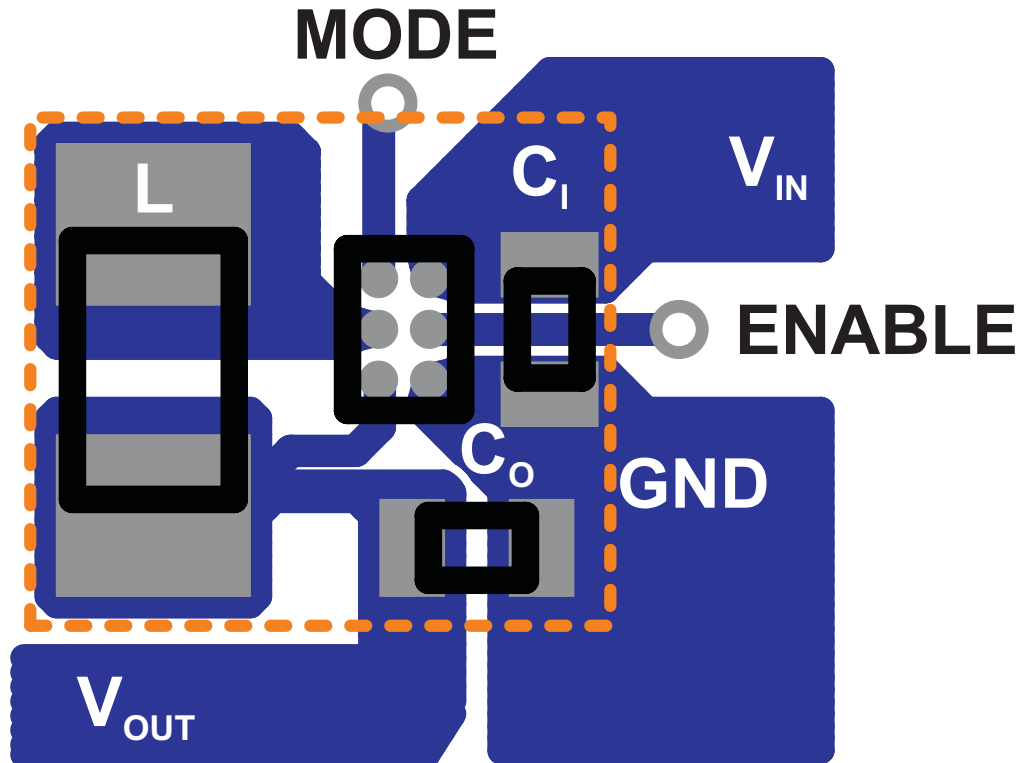

Figure 42. Suggested Layout (Top)

THERMAL INFORMATION

Implementation of integrated circuits in low-profile and fine-pitch surface-mount packages typically requires special attention to power dissipation. Many system-dependant issues such as thermal coupling, airflow, added heat sinks, and convection surfaces, and the presence of other heat-generating components, affect the power-dissipation limits of a given component

Three basic approaches for enhancing thermal performance are listed below:

- Improving the power dissipation capability of the PCB design
- Improving the thermal coupling of the component to the PCB
- Introducing airflow in the system

The maximum recommended junction temperature (T_J) of the TPS6266x devices is 105°C. The thermal resistance of the 6-pin CSP package (YFF-6) is $R_{\theta JA} = 125^\circ\text{C/W}$. Regulator operation is specified to a maximum ambient temperature T_A of 85°C. Therefore, the maximum steady state power dissipation is about 160 mW.

$$P_{D(MA)} = \frac{T_{J(MAX)} - T_A}{R_{\theta JA}} = \frac{105^\circ\text{C} - 85^\circ\text{C}}{125^\circ\text{C/W}} = 160 \text{ mW} \quad (2)$$

PACKAGE SUMMARY

CHIP SCALE PACKAGE
(BOTTOM VIEW)

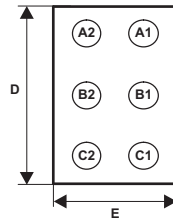

CHIP SCALE PACKAGE
(TOP VIEW)

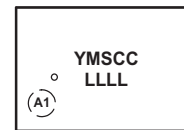

Code:

- YM — Year Month date Code
- S — Assembly site code
- CC — Chip code
- LLLL — Lot trace code

CHIP SCALE PACKAGE DIMENSIONS

The TPS6266x device is available in an 6-bump chip scale package (YFF, NanoFree™). The package dimensions are given as:

- $D = 1.30 \pm 0.03 \text{ mm}$
- $E = 0.926 \pm 0.03 \text{ mm}$

NOTE: Page numbers of current version may differ from previous versions.

Changes from Original (February 2010) to Revision A **Page**

- Deleted Product Preview banner for device release to production. **1**
-

Changes from Revision A (March 2010) to Revision B **Page**

- Deleted "Product Preview" footnote associated with TPS62665YFF device. **2**
-

Changes from Revision B (September 2010) to Revision C **Page**

- Changed in ELEC CHARA table, Shutdown current row, Max from 1 to 2.5 **3**
-

PACKAGING INFORMATION

| Orderable Device | Status (1) | Package Type | Package Drawing | Pins | Package Qty | Eco Plan (2) | Lead/Ball Finish (6) | MSL Peak Temp (3) | Op Temp (°C) | Device Marking (4/5) | Samples |
|------------------|---------------|--------------|-----------------|------|-------------|-------------------------|-------------------------|----------------------|--------------|-------------------------|-------------------------|
| TPS62660YFFR | ACTIVE | DSBGA | YFF | 6 | 3000 | Green (RoHS & no Sb/Br) | Call TI | Level-1-260C-UNLIM | -40 to 85 | OO | Samples |
| TPS62660YFFT | ACTIVE | DSBGA | YFF | 6 | 250 | Green (RoHS & no Sb/Br) | Call TI | Level-1-260C-UNLIM | -40 to 85 | OO | Samples |
| TPS62661YFFR | PREVIEW | DSBGA | YFF | 6 | | TBD | Call TI | Call TI | -40 to 85 | KH | |
| TPS62661YFFT | PREVIEW | DSBGA | YFF | 6 | | TBD | Call TI | Call TI | -40 to 85 | KH | |
| TPS62665YFFR | ACTIVE | DSBGA | YFF | 6 | 3000 | Green (RoHS & no Sb/Br) | SNAGCU | Level-1-260C-UNLIM | -40 to 85 | RS | Samples |
| TPS62665YFFT | ACTIVE | DSBGA | YFF | 6 | 250 | Green (RoHS & no Sb/Br) | SNAGCU | Level-1-260C-UNLIM | -40 to 85 | RS | Samples |

(1) The marketing status values are defined as follows:

ACTIVE: Product device recommended for new designs.

LIFEBUY: TI has announced that the device will be discontinued, and a lifetime-buy period is in effect.

NRND: Not recommended for new designs. Device is in production to support existing customers, but TI does not recommend using this part in a new design.

PREVIEW: Device has been announced but is not in production. Samples may or may not be available.

OBSOLETE: TI has discontinued the production of the device.

(2) Eco Plan - The planned eco-friendly classification: Pb-Free (RoHS), Pb-Free (RoHS Exempt), or Green (RoHS & no Sb/Br) - please check <http://www.ti.com/productcontent> for the latest availability information and additional product content details.

TBD: The Pb-Free/Green conversion plan has not been defined.

Pb-Free (RoHS): TI's terms "Lead-Free" or "Pb-Free" mean semiconductor products that are compatible with the current RoHS requirements for all 6 substances, including the requirement that lead not exceed 0.1% by weight in homogeneous materials. Where designed to be soldered at high temperatures, TI Pb-Free products are suitable for use in specified lead-free processes.

Pb-Free (RoHS Exempt): This component has a RoHS exemption for either 1) lead-based flip-chip solder bumps used between the die and package, or 2) lead-based die adhesive used between the die and leadframe. The component is otherwise considered Pb-Free (RoHS compatible) as defined above.

Green (RoHS & no Sb/Br): TI defines "Green" to mean Pb-Free (RoHS compatible), and free of Bromine (Br) and Antimony (Sb) based flame retardants (Br or Sb do not exceed 0.1% by weight in homogeneous material)

(3) MSL, Peak Temp. - The Moisture Sensitivity Level rating according to the JEDEC industry standard classifications, and peak solder temperature.

(4) There may be additional marking, which relates to the logo, the lot trace code information, or the environmental category on the device.

(5) Multiple Device Markings will be inside parentheses. Only one Device Marking contained in parentheses and separated by a "~" will appear on a device. If a line is indented then it is a continuation of the previous line and the two combined represent the entire Device Marking for that device.

⁽⁶⁾ Lead/Ball Finish - Orderable Devices may have multiple material finish options. Finish options are separated by a vertical ruled line. Lead/Ball Finish values may wrap to two lines if the finish value exceeds the maximum column width.

Important Information and Disclaimer:The information provided on this page represents TI's knowledge and belief as of the date that it is provided. TI bases its knowledge and belief on information provided by third parties, and makes no representation or warranty as to the accuracy of such information. Efforts are underway to better integrate information from third parties. TI has taken and continues to take reasonable steps to provide representative and accurate information but may not have conducted destructive testing or chemical analysis on incoming materials and chemicals. TI and TI suppliers consider certain information to be proprietary, and thus CAS numbers and other limited information may not be available for release.

In no event shall TI's liability arising out of such information exceed the total purchase price of the TI part(s) at issue in this document sold by TI to Customer on an annual basis.

TAPE AND REEL INFORMATION

QUADRANT ASSIGNMENTS FOR PIN 1 ORIENTATION IN TAPE

*All dimensions are nominal

| Device | Package Type | Package Drawing | Pins | SPQ | Reel Diameter (mm) | Reel Width W1 (mm) | A0 (mm) | B0 (mm) | K0 (mm) | P1 (mm) | W (mm) | Pin1 Quadrant |
|--------------|--------------|-----------------|------|------|--------------------|--------------------|---------|---------|---------|---------|--------|---------------|
| TPS62660YFFR | DSBGA | YFF | 6 | 3000 | 180.0 | 8.4 | 1.07 | 1.42 | 0.74 | 4.0 | 8.0 | Q1 |
| TPS62660YFFT | DSBGA | YFF | 6 | 250 | 180.0 | 8.4 | 1.07 | 1.42 | 0.74 | 4.0 | 8.0 | Q1 |
| TPS62665YFFR | DSBGA | YFF | 6 | 3000 | 180.0 | 8.4 | 1.07 | 1.42 | 0.74 | 4.0 | 8.0 | Q1 |
| TPS62665YFFT | DSBGA | YFF | 6 | 250 | 180.0 | 8.4 | 1.07 | 1.42 | 0.74 | 4.0 | 8.0 | Q1 |

TAPE AND REEL BOX DIMENSIONS



*All dimensions are nominal

| Device | Package Type | Package Drawing | Pins | SPQ | Length (mm) | Width (mm) | Height (mm) |
|--------------|--------------|-----------------|------|------|-------------|------------|-------------|
| TPS62660YFFR | DSBGA | YFF | 6 | 3000 | 182.0 | 182.0 | 20.0 |
| TPS62660YFFT | DSBGA | YFF | 6 | 250 | 182.0 | 182.0 | 20.0 |
| TPS62665YFFR | DSBGA | YFF | 6 | 3000 | 182.0 | 182.0 | 20.0 |
| TPS62665YFFT | DSBGA | YFF | 6 | 250 | 182.0 | 182.0 | 20.0 |

MECHANICAL DATA

YFF (R-XBGA-N6)

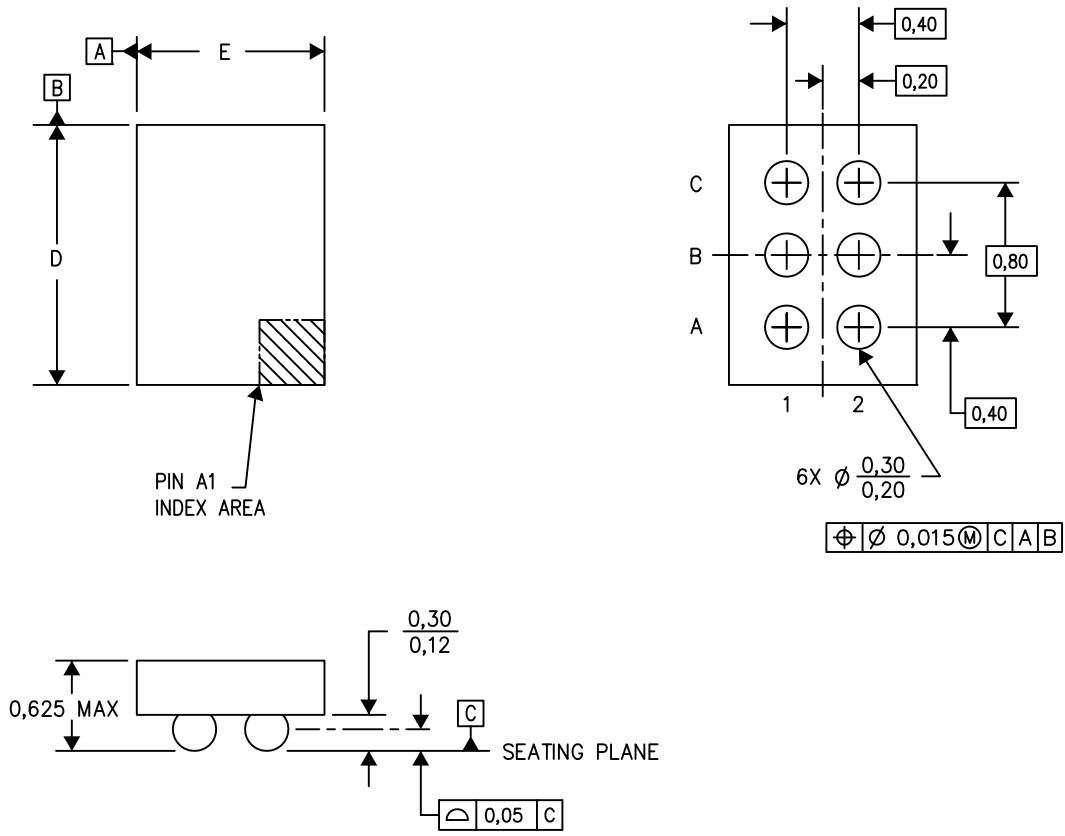
DIE-SIZE BALL GRID ARRAY



D: Max = 1.33 mm, Min = 1.27 mm

E: Max = 0.956 mm, Min = 0.896 mm

4207625-4/AN 07/13

- NOTES: A. All linear dimensions are in millimeters. Dimensioning and tolerancing per ASME Y14.5M-1994.
 B. This drawing is subject to change without notice.
 C. NanoFree™ package configuration.

PowerPAD is a trademark of Texas Instruments.

IMPORTANT NOTICE

Texas Instruments Incorporated and its subsidiaries (TI) reserve the right to make corrections, enhancements, improvements and other changes to its semiconductor products and services per JESD46, latest issue, and to discontinue any product or service per JESD48, latest issue. Buyers should obtain the latest relevant information before placing orders and should verify that such information is current and complete. All semiconductor products (also referred to herein as "components") are sold subject to TI's terms and conditions of sale supplied at the time of order acknowledgment.

TI warrants performance of its components to the specifications applicable at the time of sale, in accordance with the warranty in TI's terms and conditions of sale of semiconductor products. Testing and other quality control techniques are used to the extent TI deems necessary to support this warranty. Except where mandated by applicable law, testing of all parameters of each component is not necessarily performed.

TI assumes no liability for applications assistance or the design of Buyers' products. Buyers are responsible for their products and applications using TI components. To minimize the risks associated with Buyers' products and applications, Buyers should provide adequate design and operating safeguards.

TI does not warrant or represent that any license, either express or implied, is granted under any patent right, copyright, mask work right, or other intellectual property right relating to any combination, machine, or process in which TI components or services are used. Information published by TI regarding third-party products or services does not constitute a license to use such products or services or a warranty or endorsement thereof. Use of such information may require a license from a third party under the patents or other intellectual property of the third party, or a license from TI under the patents or other intellectual property of TI.

Reproduction of significant portions of TI information in TI data books or data sheets is permissible only if reproduction is without alteration and is accompanied by all associated warranties, conditions, limitations, and notices. TI is not responsible or liable for such altered documentation. Information of third parties may be subject to additional restrictions.

Resale of TI components or services with statements different from or beyond the parameters stated by TI for that component or service voids all express and any implied warranties for the associated TI component or service and is an unfair and deceptive business practice. TI is not responsible or liable for any such statements.

Buyer acknowledges and agrees that it is solely responsible for compliance with all legal, regulatory and safety-related requirements concerning its products, and any use of TI components in its applications, notwithstanding any applications-related information or support that may be provided by TI. Buyer represents and agrees that it has all the necessary expertise to create and implement safeguards which anticipate dangerous consequences of failures, monitor failures and their consequences, lessen the likelihood of failures that might cause harm and take appropriate remedial actions. Buyer will fully indemnify TI and its representatives against any damages arising out of the use of any TI components in safety-critical applications.

In some cases, TI components may be promoted specifically to facilitate safety-related applications. With such components, TI's goal is to help enable customers to design and create their own end-product solutions that meet applicable functional safety standards and requirements. Nonetheless, such components are subject to these terms.

No TI components are authorized for use in FDA Class III (or similar life-critical medical equipment) unless authorized officers of the parties have executed a special agreement specifically governing such use.

Only those TI components which TI has specifically designated as military grade or "enhanced plastic" are designed and intended for use in military/aerospace applications or environments. Buyer acknowledges and agrees that any military or aerospace use of TI components which have **not** been so designated is solely at the Buyer's risk, and that Buyer is solely responsible for compliance with all legal and regulatory requirements in connection with such use.

TI has specifically designated certain components as meeting ISO/TS16949 requirements, mainly for automotive use. In any case of use of non-designated products, TI will not be responsible for any failure to meet ISO/TS16949.

Products

| | |
|------------------------------|--|
| Audio | www.ti.com/audio |
| Amplifiers | amplifier.ti.com |
| Data Converters | dataconverter.ti.com |
| DLP® Products | www.dlp.com |
| DSP | dsp.ti.com |
| Clocks and Timers | www.ti.com/clocks |
| Interface | interface.ti.com |
| Logic | logic.ti.com |
| Power Mgmt | power.ti.com |
| Microcontrollers | microcontroller.ti.com |
| RFID | www.ti-rfid.com |
| OMAP Applications Processors | www.ti.com/omap |
| Wireless Connectivity | www.ti.com/wirelessconnectivity |

Applications

| | |
|-------------------------------|--|
| Automotive and Transportation | www.ti.com/automotive |
| Communications and Telecom | www.ti.com/communications |
| Computers and Peripherals | www.ti.com/computers |
| Consumer Electronics | www.ti.com/consumer-apps |
| Energy and Lighting | www.ti.com/energy |
| Industrial | www.ti.com/industrial |
| Medical | www.ti.com/medical |
| Security | www.ti.com/security |
| Space, Avionics and Defense | www.ti.com/space-avionics-defense |
| Video and Imaging | www.ti.com/video |

TI E2E Community

e2e.ti.com