

Ultrasonic sensor

UB300-18GM40-E5-V1



- Short design, 40 mm
- Function indicators visible from all directions
- Switch output
- 5 different output functions can be set
- Program input
- Temperature compensation

Single head system



Dimensions

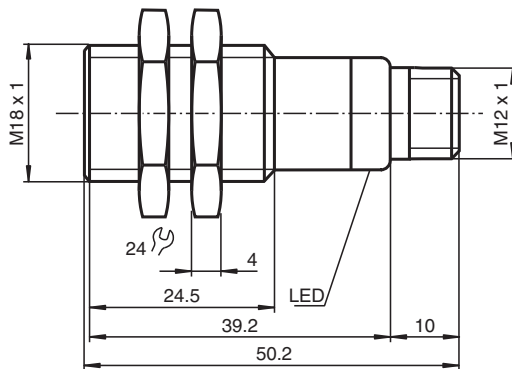

Technical Data

General specifications

Sensing range	35 ... 300 mm
Adjustment range	50 ... 300 mm
Dead band	0 ... 35 mm
Standard target plate	100 mm x 100 mm
Transducer frequency	approx. 390 kHz
Response delay	approx. 50 ms

Indicators/operating means

LED green	Power on
LED yellow	indication of the switching state flashing: program function object detected

Release date: 2021-02-25 Date of issue: 2021-02-25 Filename: 220357_eng.pdf

Refer to "General Notes Relating to Pepperl+Fuchs Product Information".

Pepperl+Fuchs Group
www.pepperl-fuchs.com

USA: +1 330 486 0001
fa-info@us.pepperl-fuchs.com

Germany: +49 621 776 1111
fa-info@de.pepperl-fuchs.com

Singapore: +65 6779 9091
fa-info@sg.pepperl-fuchs.com

PF PEPPERL+FUCHS

Technical Data

LED red		solid red: Error red, flashing: program function, object not detected
Electrical specifications		
Operating voltage	U_B	10 ... 30 V DC , ripple 10 % _{SS}
No-load supply current	I_0	≤ 20 mA
Input		
Input type		1 program input operating distance 1: $-U_B \dots +1$ V, operating distance 2: $+6$ V ... $+U_B$ input impedance: > 4,7 kΩ program pulse: ≥ 1 s
Output		
Output type		1 switching output E5, PNP NO/NC, programmable
Rated operating current	I_e	200 mA , short-circuit/overload protected
Default setting		Switch point A1: 50 mm Switch point A2: 300 mm
Voltage drop	U_d	≤ 3 V
Repeat accuracy		≤ 1 %
Switching frequency	f	≤ 13 Hz
Range hysteresis	H	1 % of the set operating distance
Temperature influence		± 1.5 % of full-scale value
Compliance with standards and directives		
Standard conformity		
Standards		EN 60947-5-2:2007+A1:2012 IEC 60947-5-2:2007 + A1:2012
Approvals and certificates		
UL approval		cULus Listed, General Purpose
CSA approval		cCSAus Listed, General Purpose
CCC approval		CCC approval / marking not required for products rated ≤36 V
Ambient conditions		
Ambient temperature		-25 ... 70 °C (-13 ... 158 °F)
Storage temperature		-40 ... 85 °C (-40 ... 185 °F)
Mechanical specifications		
Connection type		Connector M12 x 1 , 4-pin
Degree of protection		IP67
Material		
Housing		brass, nickel-plated
Transducer		epoxy resin/hollow glass sphere mixture; foam polyurethane, cover PBT
Mass		25 g

Connection

Standard symbol/Connections:
(version E5, pnp)

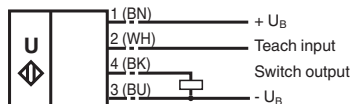

Core colours in accordance with EN 60947-5-2.

Release date: 2021-02-25 Date of issue: 2021-02-25 Filename: 220357_eng.pdf

Connection Assignment

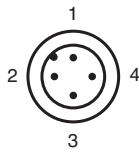

Wire colors in accordance with EN 60947-5-2

1	BN	(brown)
2	WH	(white)
3	BU	(blue)
4	BK	(black)

Characteristic Curve

Characteristic response curve

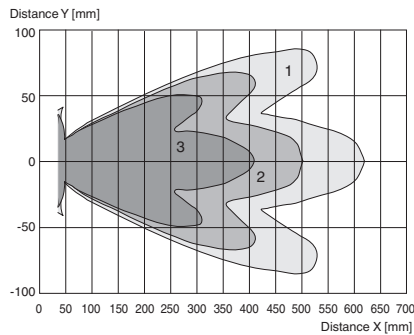

Curve 1: flat surface 100 mm x 100 mm
 Curve 2: flat surface 10 mm x 10 mm
 Curve 3: round bar, Ø 25 mm



Programming

Programmable output modes









- Window mode, normally open mode
 $A1 < A2$: object distance →
- Window mode, normally closed mode
 $A2 < A1$:
- One switch point, normally open mode
 $A1 \rightarrow \infty$:
- One switch point, normally closed mode
 $A2 \rightarrow \infty$:
- $A1 \rightarrow \infty, A2 \rightarrow \infty$: Object presence detection mode
 Object detected: Switch output closed
 No object detected: Switch output open

Accessories

	UB-PROG2	Programming unit
--	-----------------	------------------

Release date: 2021-02-25 Date of issue: 2021-02-25 Filename: 220357_eng.pdf

Accessories

	OMH-04	Mounting aid for round steel ø 12 mm or sheet 1.5 mm ... 3 mm
	BF 18	Mounting flange, 18 mm
	BF 18-F	Plastic mounting adapter, 18 mm
	BF 5-30	Universal mounting bracket for cylindrical sensors with a diameter of 5 ... 30 mm
	V1-G-2M-PVC	Female cordset single-ended M12 straight A-coded, 4-pin, PVC cable grey
	V1-W-2M-PUR	Female cordset single-ended M12 angled A-coded, 4-pin, PUR cable grey
	UVW90-K18	Ultrasonic -deflector
	M18K-VE	Plastic nuts with centering ring for the vibration-free mounting of cylindrical sensors

Release date: 2021-02-25 Date of issue: 2021-02-25 Filename: 220357_eng.pdf

Refer to "General Notes Relating to Pepperl+Fuchs Product Information".

Pepperl+Fuchs Group
www.pepperl-fuchs.com

USA: +1 330 486 0001
fa-info@us.pepperl-fuchs.com

Germany: +49 621 776 1111
fa-info@de.pepperl-fuchs.com

Singapore: +65 6779 9091
fa-info@sg.pepperl-fuchs.com

Teach-In

Adjusting the switching points

The ultrasonic sensor features a switch output with two teachable switching points. These are set by applying the supply voltage $-U_B$ or $+U_B$ to the TEACH-IN input. The supply voltage must be applied to the TEACH-IN input for at least 1 s. LEDs indicate whether the sensor has recognised the target during the TEACH-IN procedure. Switching point A1 is taught with $-U_B$, A2 with $+U_B$.

Five different output functions can be set

1. Window mode, normally-open function
2. Window mode, normally-closed function
3. one switching point, normally-open function
4. one switching point, normally-closed function
5. Detection of object presence

TEACH-IN window mode, normally-open function

- Set target to near switching point
- TEACH-IN switching point A1 with $-U_B$
- Set target to far switching point
- TEACH-IN switching point A2 with $+U_B$

TEACH-IN window mode, normally-closed function

- Set target to near switching point
- TEACH-IN switching point A2 with $+U_B$
- Set target to far switching point
- TEACH-IN switching point A1 with $-U_B$

TEACH-IN switching point, normally-open function

- Set target to near switching point
- TEACH-IN switching point A2 with $+U_B$
- Cover sensor with hand or remove all objects from sensing range
- TEACH-IN switching point A1 with $-U_B$

TEACH-IN switching point, normally-closed function

- Set target to near switching point
- TEACH-IN switching point A1 with $-U_B$
- Cover sensor with hand or remove all objects from sensing range
- TEACH-IN switching point A2 with $+U_B$

TEACH-IN detection of objects presence

- Cover sensor with hand or remove all objects from sensing range
- TEACH-IN switching point A1 with $-U_B$
- TEACH-IN switching point A2 with $+U_B$

LED Displays

Displays in dependence on operating mode	Red LED	Yellow LED
TEACH-IN switching point:		
Object detected	off	flashes
No object detected	flashes	off
Object uncertain (TEACH-IN invalid)	On	off
Normal operation	off	Switching state
Fault	on	Previous state

Installation Conditions

If the sensor is installed at places, where the environment temperature can fall below 0 °C, for the sensors fixation, one of the mounting flanges BF18, BF18-F or BF 5-30 must be used.

In case of direct mounting of the sensor in a through hole using the steel nuts, it has to be fixed at the middle of the housing thread. If a fixation at the front end of the threaded housing is required, plastic nuts with centering ring (accessories) must be used.

Release date: 2021-02-25 Date of issue: 2021-02-25 Filename: 220357_eng.pdf