

### FEATURES

- 200mV Max Dropout at 10mA Output Current
- 4 $\mu$ A Typical Quiescent Current
- 0.15% Max Initial Accuracy (S8)
- No Output Capacitor Required
- Output Sources 10mA, Sinks 2mA
- 40ppm/ $^{\circ}$ C Max Drift (S8)
- Available in Small MSOP Package
- Voltage Options: 2.5V, 3V, 4.1V, 5V and Adjustable

### APPLICATIONS

- Battery-Powered Systems
- Handheld Instruments
- Precision Power Supplies
- A/D and D/A Converters

### DESCRIPTION

The LTC<sup>®</sup>1258/LTC1258-2.5/LTC1258-3/LTC1258-4.1/LTC1258-5 are micropower bandgap references that combine high accuracy and low drift with very low supply current and small package size. The combination of ultralow quiescent current and low dropout voltage of only 200mV max. makes them ideal for battery-powered equipment. The output voltage is set by an external resistor divider for the adjustable LTC1258.

This series of references uses curvature compensation to obtain low temperature coefficient and trimmed thin-film resistors to achieve high output accuracy. These references can source up to 10mA and sink up to 2mA, making them ideal for precision regulator applications. They are stable without an output bypass capacitor, but are also stable with capacitance up to 1 $\mu$ F. This feature is important in critical applications where PC board space is a premium and fast settling is demanded.

The LTC1258 series references provide power dissipation advantages over shunt references. In addition to supply current, shunt references must also idle the entire load current to operate.

The LTC1258 series is available in the 8-pin MSOP and SO packages.

 LTC and LT are registered trademarks of Linear Technology Corporation.

### TYPICAL APPLICATION

2.5V Battery-Powered Reference

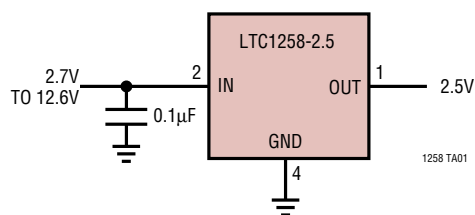

LTC1258-2.5 Temperature Drift

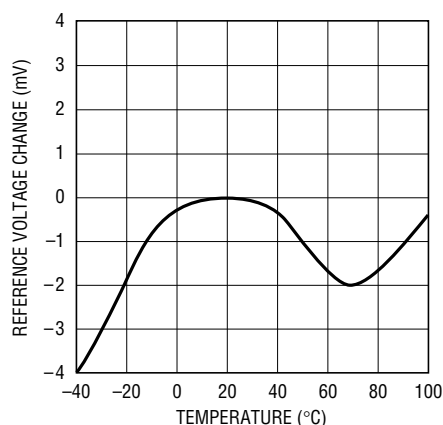

1258 TA02

# LTC1258 Series

## ABSOLUTE MAXIMUM RATINGS

(Note 1)

Supply Voltage ..... 13V  
 Input Voltages ..... -0.3V to 13V  
 Output Voltages ..... -0.3V to 13V  
 Output Short Circuit Duration ..... Indefinite

Operating Temperature Range (Note 2) -40°C to 100°C  
 Specified Temperature Range ..... 0°C to 70°C  
 Storage Temperature Range (Note 3) .... -65°C to 150°C  
 Lead Temperature (Soldering, 10 sec) ..... 300°C

## PACKAGE/ORDER INFORMATION

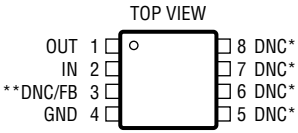
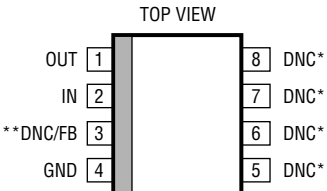
 <p>MS8 PACKAGE 8-LEAD PLASTIC MSOP</p> <p>* CONNECTED INTERNALLY. DO NOT CONNECT EXTERNAL CIRCUITRY TO THESE PINS                      ** DNC FOR LTC1258-2.5/LTC1258-3/LTC1258-4.1/LTC1258-5, FB FOR LTC1258</p> <p><math>T_{JMAX} = 125^{\circ}C, \theta_{JA} = 250^{\circ}C/W</math></p>	ORDER PART NUMBER	 <p>S8 PACKAGE 8-LEAD PLASTIC SO</p> <p>* CONNECTED INTERNALLY. DO NOT CONNECT EXTERNAL CIRCUITRY TO THESE PINS                      ** DNC FOR LTC1258-2.5/LTC1258-3/LTC1258-4.1/LTC1258-5, FB FOR LTC1258</p> <p><math>T_{JMAX} = 125^{\circ}C, \theta_{JA} = 190^{\circ}C/W</math></p>	ORDER PART NUMBER
			LTC1258CMS8 LTC1258CMS8-2.5 LTC1258CMS8-3 LTC1258CMS8-4.1 LTC1258CMS8-5
	MS8 PART MARKING		S8 PART MARKING
	LTEL LTCF LTEU LTEN LTEM		1258 12582 12583 125841 12585

Consult factory for Industrial and Military grade parts.

## AVAILABLE OPTIONS

OUTPUT VOLTAGE (V)	TEMPERATURE RANGE (°C)	ACCURACY (%)	TEMPERATURE COEFFICIENT (ppm/°C)	PACKAGE TYPE			
				S8		MS8	
				ORDER NUMBER	PART MARKING	ORDER NUMBER	PART MARKING
2.5	0 to 70	0.15	40	LTC1258CS8-2.5	12582	LTC1258CMS8-2.5	LTCF
2.5	0 to 70	0.21	60				
3	0 to 70	0.15	40	LTC1258CS8-3	12583	LTC1258CMS8-3	LTEU
3	0 to 70	0.20	60				
4.096	0 to 70	0.15	40	LTC1258CS8-4.1	125841	LTC1258CMS8-4.1	LTEN
4.096	0 to 70	0.18	60				
5	0 to 70	0.15	40	LTC1258CS8-5	12585	LTC1258CMS8-5	LTEM
5	0 to 70	0.18	60				
Adjustable	0 to 70	0.4	40	LTC1258CS8	1258	LTC1258CMS8	LTEL
Adjustable	0 to 70	0.46	60				

## ELECTRICAL CHARACTERISTICS

The ● denotes specifications which apply over the specified temperature range, otherwise specifications are  $T_A = 25^\circ\text{C}$ .

$V_{IN} = V_{OUT(NOMINAL)} + 0.2\text{V}$ ,  $I_{OUT} = 0\text{mA}$ , FB = OUT for the LTC1258 unless otherwise noted.

SYMBOL	PARAMETER	CONDITIONS	MIN	TYP	MAX	UNITS
$V_{IN}$	Input Voltage Range				12.6	V
$I_{IN}$	Input Current	FB = OUT for LTC1258			6.5 8.5	$\mu\text{A}$ $\mu\text{A}$
$V_{OUT}$	Output Voltage (Note 4)	LTC1258 (S8), FB = OUT LTC1258-2.5 (S8) LTC1258-3 (S8) LTC1258-4.1 (S8) LTC1258-5 (S8) LTC1258 (MS8), FB = OUT LTC1258-2.5 (MS8) LTC1258-3 (MS8) LTC1258-4.1 (MS8) LTC1258-5 (MS8)	2.3755 2.4963 2.9955 4.090 4.9925 2.374 2.4948 2.994 4.0885 4.991	2.385 2.5 3 4.096 5 2.385 2.5 3 4.096 5	2.3945 2.5037 3.0045 4.102 5.0075 2.396 2.5052 3.006 4.1035 5.009	V V V V V V V V V V
$e_n$	Output Voltage Noise (Note 5)	$0.1\text{Hz} \leq f \leq 10\text{Hz}$		8		ppm <sub>p-p</sub>
TC	Output Voltage Temp Coefficient (Note 6)	$T_{MIN} \leq T_J \leq T_{MAX}$ (S8) $T_{MIN} \leq T_J \leq T_{MAX}$ (MS8)		15 60	40	ppm/ $^\circ\text{C}$ ppm/ $^\circ\text{C}$
$V_{OUT}/V_{IN}$	Line Regulation	$V_{IN} = (V_{OUT(NOMINAL)} + 0.2\text{V})$ to 12.6V		30	90	ppm/V
$V_{OUT}/I_{OUT}$	Load Regulation (Note 7)	Sourcing 0mA to 10mA Sinking 0mA to 2mA		0.1 1.75	0.3 4.0 6.5	mV/mA mV/mA mV/mA
$I_{SC}$	Short-Circuit Output Current	$V_{OUT}$ Shorted to GND $V_{OUT}$ Shorted to $V_{IN}$	20 2	40 4		mA mA
$\Delta V_{DO}$	Dropout Voltage (Note 8)	$I_{OUT} = 0$ , $\Delta V_{OUT} \leq 0.1\%$ $I_{OUT} = 10\text{mA}$ , $\Delta V_{OUT} \leq 0.1\%$			100 200	mV mV
$V_{HYST}$	Output Hysteresis (Note 9)	$\Delta T = -40^\circ\text{C}$ to $85^\circ\text{C}$ $\Delta T = 0^\circ\text{C}$ to $70^\circ\text{C}$		200 50		ppm ppm
$I_{FB}$	FB Pin Input Current	LTC1258, OUT = FB		10		nA

**Note 1:** Absolute Maximum Ratings are those values beyond which the life of the device may be impaired.

**Note 2:** The LTC1258 is guaranteed functional over the operating temperature range of  $-40^\circ\text{C}$  to  $100^\circ\text{C}$ .

**Note 3:** If the part is stored outside of the specified operating temperature range, the output may shift due to hysteresis.

**Note 4:** ESD (Electrostatic Discharge) sensitive device. Extensive use of ESD protection devices are used internal to the LTC1258, however, high electrostatic discharge can damage or degrade the device. Use proper ESD handling precautions.

**Note 5:** Peak-to-peak noise is measured with a single pole highpass filter at 0.1Hz and 2-pole lowpass filter at 10Hz.

**Note 6:** Temperature coefficient is the change in output voltage divided by the nominal output voltage divided by the specified temperature range.

**Note 7:** Load regulation is measured on a pulse basis from no load to the specified load current. Output changes due to die temperature change must be taken into account separately.

**Note 8:** Dropout voltage is  $(V_{IN} - V_{OUT})$  when  $V_{OUT}$  falls to 0.1% below its nominal value at  $V_{IN} = V_{OUT} + 0.5\text{V}$ .

**Note 9:** Hysteresis in output voltage is created by package stress that differs depending on whether the IC was previously at a higher or lower temperature. Output voltage is always measured at  $25^\circ\text{C}$ , but the IC is cycled hot or cold before successive measurements. Hysteresis is not normally a problem for operational temperature excursions where the instrument might be stored at high or low temperature.

## TYPICAL PERFORMANCE CHARACTERISTICS

**LTC1258-2.5\***  
Dropout Voltage vs  
Output Source Current

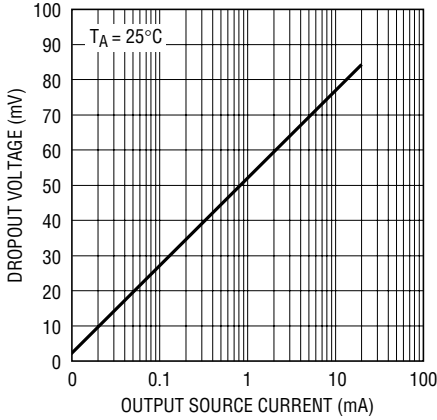

**LTC1258-2.5\***  
Input Current vs Temperature

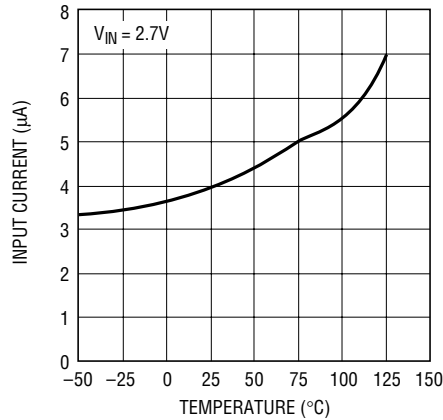

**LTC1258 Series**  
Output Short-Circuit Current vs  
Temperature

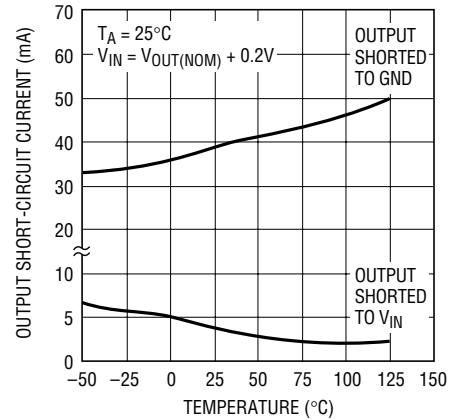

**LTC1258-2.5\*** Output Short-Circuit  
Current vs Input Voltage

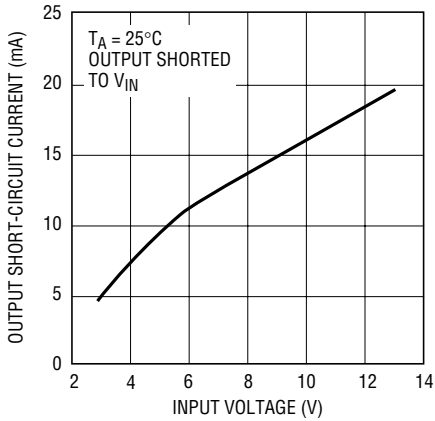

**LTC1258-2.5\*** Output Short-Circuit  
Current vs Input Voltage

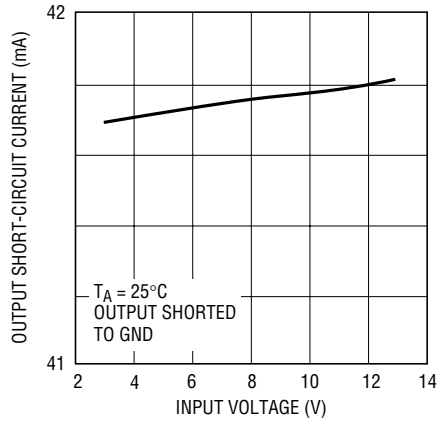

**LTC1258 Series**  
Load Regulation

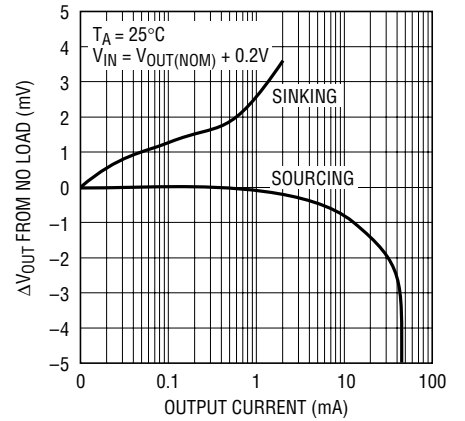

**LTC1258-2.5**  
Output Voltage vs Input Voltage

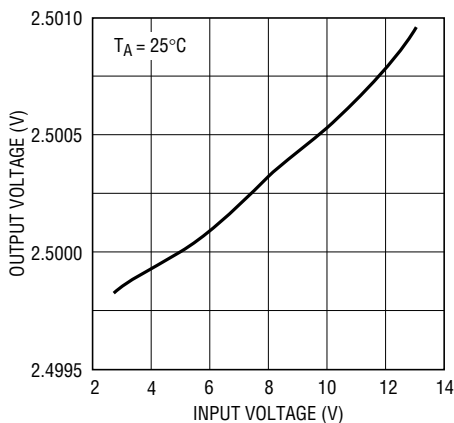

**LTC1258-2.5**  
Input Current vs Input Voltage

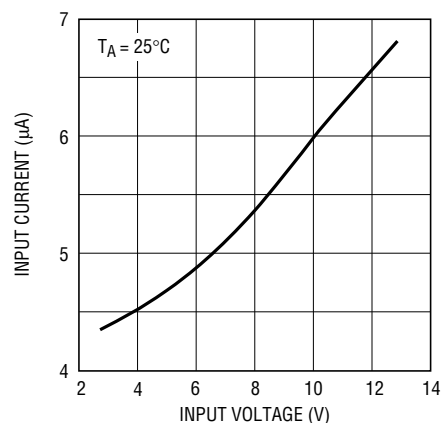

\*Similar performance characteristics can be expected for all voltage options.

## TYPICAL PERFORMANCE CHARACTERISTICS

LTC1258-2.5 PSRR vs Frequency

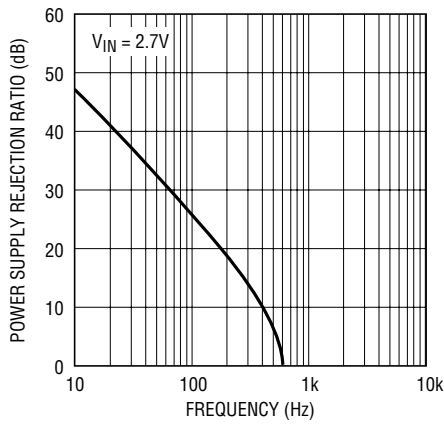

LTC1258-2.5 0.1Hz to 10Hz Noise

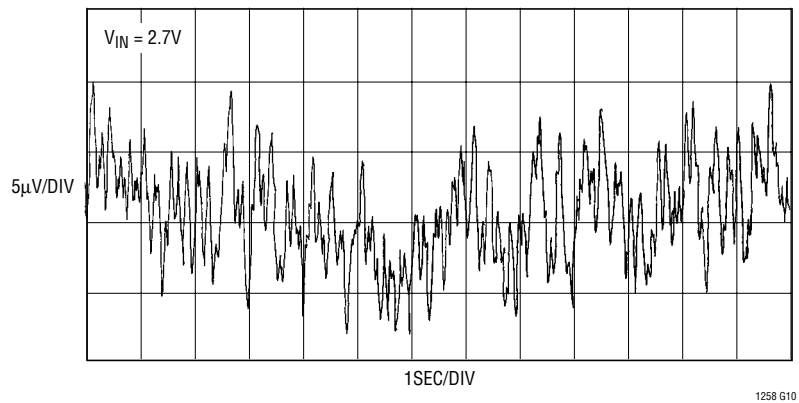

## PIN FUNCTIONS

**OUT (Pin 1):** Reference Output. The output can source up to 10mA and sink up to 2mA. It is stable with output bypass capacitor ranging from 0µF to 1µF.

**IN (Pin 2):** Positive Supply. Bypassing with a 0.1µF capacitor is recommended if the output loading changes.  $(V_{OUT} + 0.2V) \leq V_{IN} \leq 12.6V$ .

**DNC (Pin 3):** (LTC1258-2.5/LTC1258-3/LTC1258-4.1/LTC1258-5) Do Not Connect. Connected internally for post package trim. This pin must be left unconnected.

**FB (Pin 3):** (LT1258) Resistor Divider Feedback Pin. Connect a resistor divider from OUT to GND and the center tap to FB. This pin sets the output potential.

$$V_{OUT} = 2.385V \left( \frac{R1 + R2}{R2} \right)$$
; R1 is connected from OUT to FB and R2 from FB to GND.

**GND (Pin 4):** Negative Supply or Ground Connection.

**DNC (Pins 5, 6, 7, 8):** Do Not Connect. Connected internally for post package trim. These pins must be left unconnected.

## BLOCK DIAGRAM

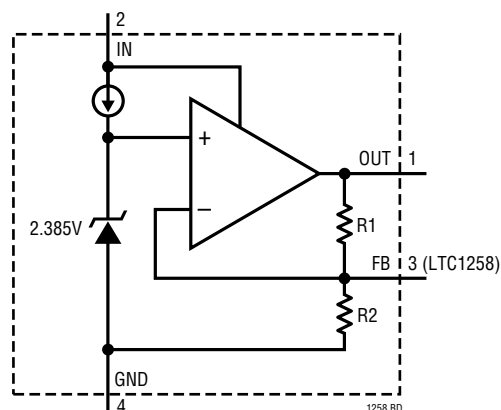

NOTE: R1 AND R2 ARE NOT CONNECTED FOR LTC1258

## APPLICATIONS INFORMATION

### Longer Battery Life

Series references have an advantage over shunt style references. To operate, shunt references require a resistor between the power supply and the output. This resistor must be chosen to supply the maximum current that is demanded by the circuit being regulated. When the circuit being controlled is not operating at this maximum current, the shunt reference must always sink this current, resulting in high power dissipation and short battery life.

The LTC1258 series low dropout references do not require a current setting resistor and can operate with any supply voltage from  $(V_{OUT(NOMINAL)} + 0.2V)$  to 12.6V. When the circuitry being regulated does not demand current, the LTC1258 series reduces its dissipation and battery life is extended. If the reference is not delivering load current it dissipates only  $10.8\mu W$  when operating on a 2.7V supply for LTC1258-2.5, yet the same connection can deliver 10mA of load current when demanded.

### Output Bypass Capacitor

The LTC1258 series is designed to be stable with or without capacitive loads. With no capacitive load, the reference is ideal for fast settling applications, or where PC board space is at a premium.

In applications with significant output loading changes, an output bypass capacitor of up to  $1\mu F$  can be used to improve the output transient response. Figure 1 shows the response of the reference to a 1mA to 0mA load step with a  $1\mu F$  output capacitor. If more than  $1\mu F$  of output capaci-

tance is required, a resistor in series with the capacitor is recommended to reduce the output ringing. Figure 2 illustrates the use of a damping resistor for capacitive loads greater than  $1\mu F$ . Figure 3 shows the resistor and capacitor values required to achieve critical damping.

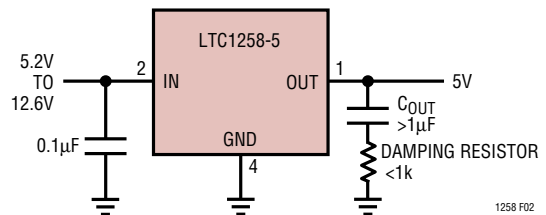

Figure 2. Adding a Damping Resistor with Output Capacitors Greater Than  $1\mu F$

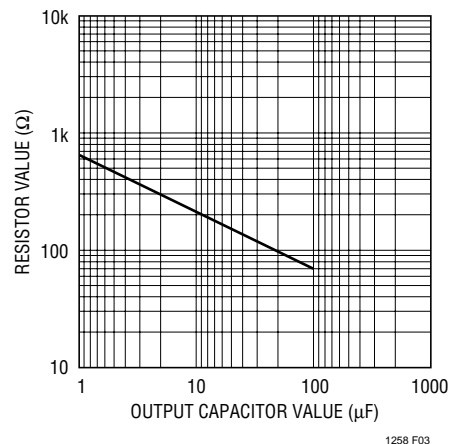

Figure 3. Damping Resistance vs Output Capacitor Value

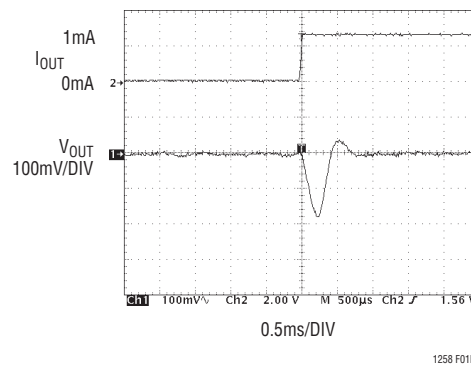
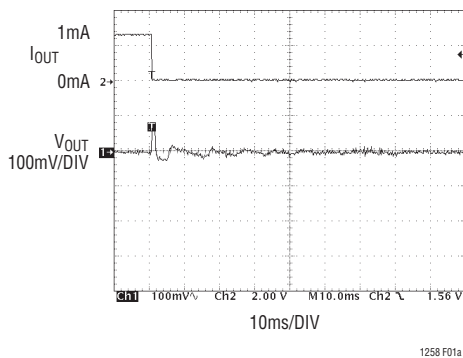

Figure 1. Reference Output Load Transient Response,  $1\mu F$  Output Capacitor

## APPLICATIONS INFORMATION

### Internal P-Channel Pass Transistor

The LTC1258 series features an internal P-channel MOSFET pass transistor. This provides several advantages over similar designs using a PNP bipolar pass transistor.

These references consume only 4 $\mu$ A of quiescent current under light and heavy loads as well as in dropout; whereas, PNP-based references waste considerable amounts of current when the pass transistor is saturated. In addition, the LTC1258 series provides a lower dropout voltage (200mV max) than PNP-based references.

## PACKAGE DESCRIPTION Dimensions in inches (millimeters) unless otherwise noted.

**MS8 Package**  
**8-Lead Plastic MSOP**  
(LTC DWG # 05-08-1660)

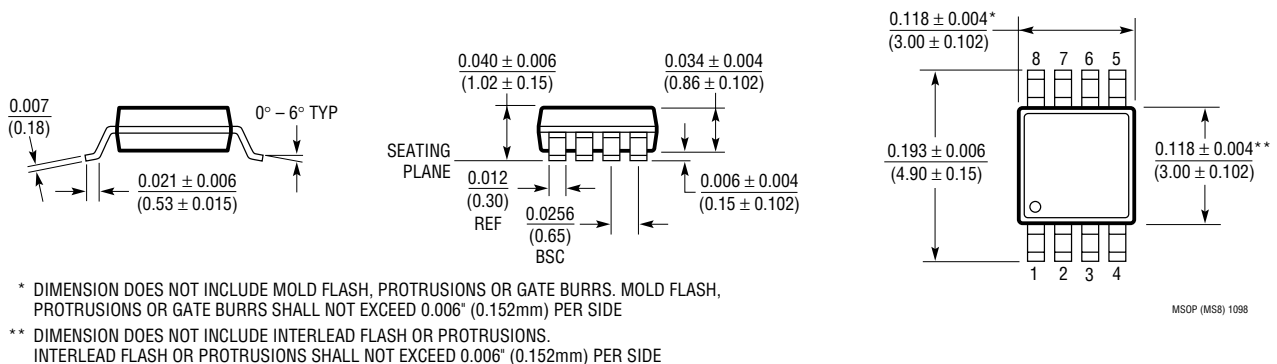

**S8 Package**  
**8-Lead Plastic Small Outline (Narrow 0.150)**  
(LTC DWG # 05-08-1610)

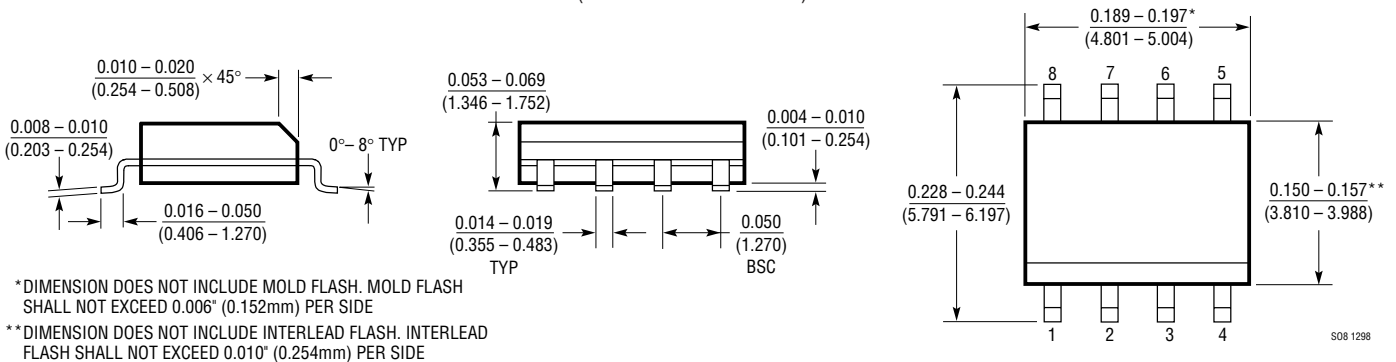

## TYPICAL APPLICATIONS

### Micropower Low Dropout Negative Reference

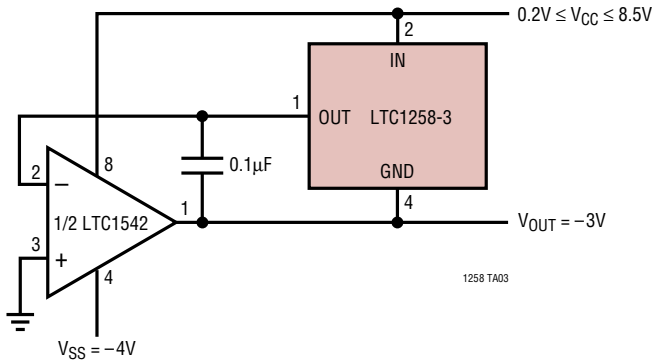

### Supply Splitter

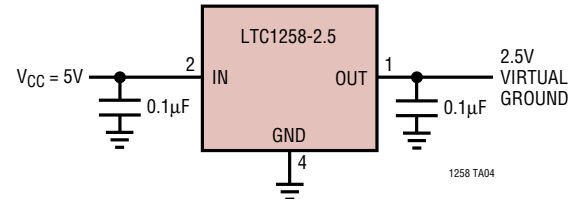

### Low Power, Low Voltage Supply Reference for LTC1096L

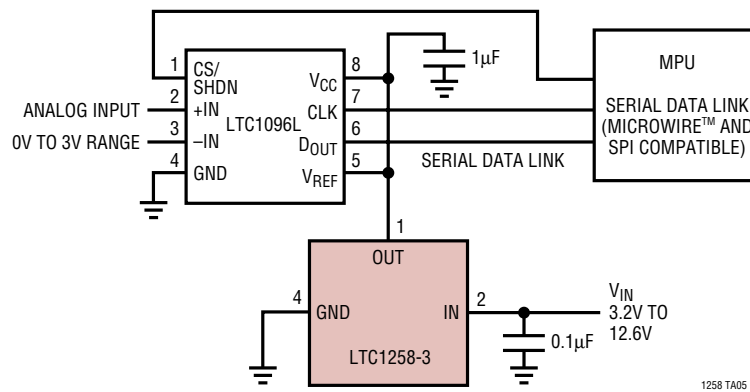

MICROWIRE is a trademark of National Semiconductor Corp.

## RELATED PARTS

PART NUMBER	DESCRIPTION	COMMENTS
LT®1389	Nanopower Precision Shunt Voltage Reference	800nA Quiescent Current, 0.05% Max, 10ppm/°C Max Drift, 1.25V and 2.5V Versions, SO-8 Package
LT1634	Micropower Precision Shunt Voltage Reference	0.05% Max, 25ppm/°C Max Drift, 1.25V, 2.5V, 4.096V and 5V Outputs
LT1460	Micropower Series Reference	0.075% Max, 10ppm/°C Max Drift, 2.5V, 5V and 10V Outputs
LTC1440	Micropower Comparator with Reference	3.7µA Max I <sub>CC</sub> , 1% 1.182V Reference, Adjustable Hysteresis
LTC1540	Nanopower Comparator with Reference	600nA Max I <sub>CC</sub> , 2% 1.182V Reference, Adjustable Hysteresis