

5A Low Dropout Positive Voltage Regulator

PL1084-XXXJ3

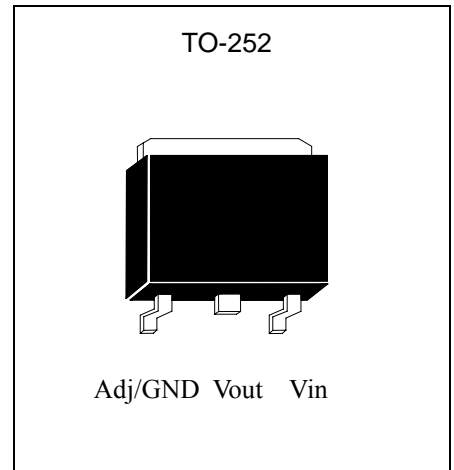

Features

- Maximum Dropout Voltage 1.5V at 5A Output Current.
- Fast Transient Response.
- Extremely Tight Line and Load Regulation.
- Current Limiting and Thermal Protection.
- Adjustable Output Voltage or Fixed 1.5V, 1.8V, 2.5V, 3.3V, 5.0V.
- Standard 3-Pin Power Packages.

Description

The PL1084-XXXJ3 is a low dropout three terminal regulator with 5A output current capability. The output voltage is adjustable with the use of a resistor divider or fixed 1.5V, 1.8V, 2.5V, 3.3V, and 5.0V. Dropout voltage is guaranteed to be at maximum of 1.5V with the maximum output current. Its low dropout voltage and fast transient response make it ideal for low voltage microprocessor applications. Current limit and thermal protection provide protection against any overload condition that would create excessive junction temperatures.

Applications

- Mother Board I/O Power Supplies.
- Microprocessor Power Supplies.
- High Current Regulator.
- Post Regulator for Switching Supply.

Typical Application Circuit

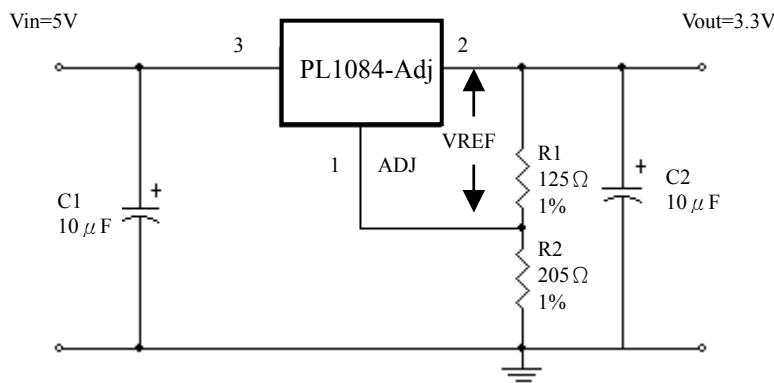

Adjustable Voltage Regulator

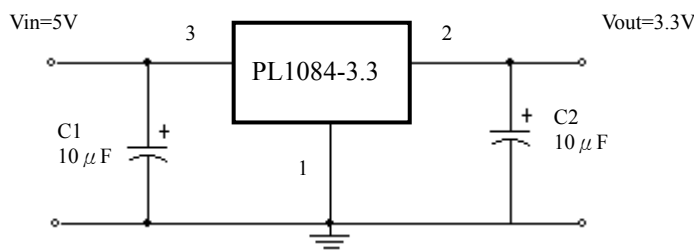

Fixed Voltage Regulator



Ordering Information

Device	Output Voltage
PL1084-AdjJ3	Adjustable
PL1084-1.5J3	1.5V
PL1084-1.8J3	1.8V
PL1084-2.5J3	2.5V
PL1084-3.3J3	3.3V
PL1084-5.0J3	5.0V

Absolute Maximum Ratings

Symbol	Parameter	Ratings	Unit
V _{in}	DC supply voltage	-0.3 to +12	V
P _D	Power Dissipation	Internally Limited	
T _{STG}	Storage Temperature	-65 ~ +150	°C
T _{OPR}	Operating Junction Temperature	0 ~ +150	°C

Electrical Characteristics (I_o=10mA, T_j=25°C, unless otherwise noted)

Symbol	Parameter	Conditions	Min	Typ	Max	Units
V _{REF}	Reference Voltage	V _{in} -V _{out} =1.5V	1.225	1.250	1.275	V
V _o	Output Voltage	PL1084-1.5 3V ≤ V _{in} ≤ 12V PL1084-1.8 3.3V ≤ V _{in} ≤ 12V PL1084-2.5 4V ≤ V _{in} ≤ 12V PL1084-3.3 4.8V ≤ V _{in} ≤ 12V PL1084-5.0 6.5V ≤ V _{in} ≤ 12V	1.470 1.764 2.450 3.235 4.900	1.500 1.800 2.500 3.300 5.000	1.530 1.836 2.550 3.365 5.100	V
ΔV _o	Line Regulation	Fixed: V _{out} +1.5V ≤ V _{in} ≤ 12V	-	-	0.2	%
ΔV _o	Load Regulation(Note 1, 2)	Adj Vin=3.3V, 0 ≤ I _o ≤ 5A	-	-	1	%
		PL1084-1.5 Vin=3.0V, 0 ≤ I _o ≤ 5A	-	12	15	mV
		PL1084-1.8 Vin=3.3V, 0 ≤ I _o ≤ 5A	-	15	18	
		PL1084-2.5 Vin=4.0V, 0 ≤ I _o ≤ 5A	-	20	25	
		PL1084-3.3 Vin=5.0V, 0 ≤ I _o ≤ 5A	-	26	33	
		PL1084-5.0 Vin=8.0V, 0 ≤ I _o ≤ 5A	-	40	50	
V _D	Dropout Voltage	I _o =5A (ΔV _{out} =1%V _{out})	-	1.4	1.5	V
I _s	Current Limit	V _{in} -V _{out} =5V	5.1	-	-	A
I _{Adj}	Adjust Pin Current	V _{in} =12V, I _o =10mA	-	55	100	μA
I _Q	Quiescent Current	V _{in} =12V, I _o =0mA(fixed model)	-	-	12	mA
T _s	Temperature Stability	I _o =10mA, 0°C ≤ T _j ≤ 125°C	-	0.5	-	%
I _L	Minimum Load Current	V _{in} =5V(adjustable model)	-	5	10	mA
θ _{JA}	Thermal Resistance, Junction to Ambient(No Heat Sink; No air flow)		-	98	-	°C/W
θ _{JC}	Thermal Resistance, Junction to Case		-	15	-	°C/W

- Note: 1. See thermal regulation specifications for changes in output voltage due to heating effects. Line and load regulation are measured at a constant junction temperature by low duty cycle pulse testing. Load regulation is measured at the output lead =1/18" from the package.
2. Line and load regulation are guaranteed up to the maximum power dissipation of 15W. Power dissipation is determined by the difference between input and output and the output current. Guaranteed maximum power dissipation will not be over the full input/output range.

Block Diagram

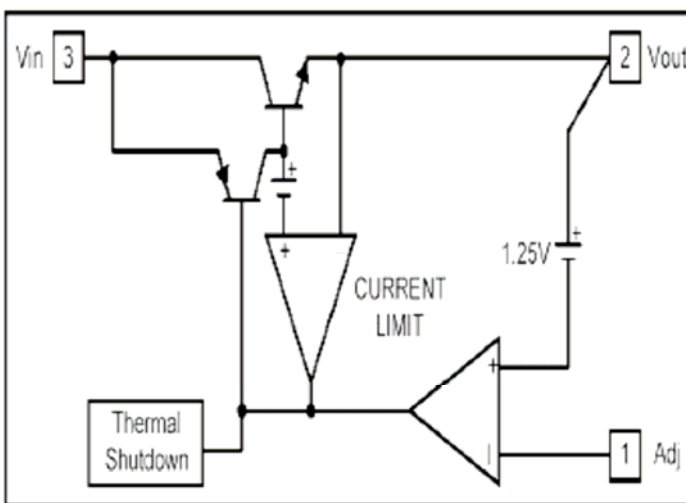

Functional Description

Introduction

The PL1084 adjustable Low Dropout(LDO) regulator is a 3 terminal device that can easily be programmed with the addition of two external resistors to any voltages within the range of 1.25V to 2.5V. The PL1084 only needs 1.5V differential between V_{in} and V_{out} to maintain output regulation. In addition, the output voltage tolerances are also extremely tight and they include the transient response as part of the specification. For example, Intel VRE specification calls for a total of $\pm 100\text{mV}$ including initial tolerance, load regulation and 0 to 5A load step. The PL1084 is specifically designed to meet the fast current transient needs as well as providing an accurate initial voltage, reducing the overall system cost with the need for fewer output capacitors.

Output Voltage Setting

The PL1084 can be programmed to any voltages in the range of 1.25V to 5V with the addition of R_1 and R_2 external resistors according to the following formula:

$$V_{out} = V_{ref}(1 + R_2/R_1) + I_{adj} * R_2, \text{ where } V_{ref} = 1.25\text{V typically, } I_{adj} = 55\mu\text{A typically}$$

The PL1084 keeps a constant 1.25V between the output pin and the adjust pin. By placing a resistor R_1 across these two pins, a constant current flows through R_1 , adding to the I_{adj} current requirement of the PL1084. R_1 is typically selected to be 121Ω resistor so that it automatically satisfies the minimum current requirement. Notice that since I_{adj} is typically in the range of $55\mu\text{A}$, it only adds a small error to the output voltage and should only be considered when a very precise output voltage setting is required. For example, in a typical 3.3V application where $R_1 = 121\Omega$ and $R_2 = 200\Omega$, the error due to I_{adj} is only 0.3% of the nominal set point.



Load Regulation

Since the PL1084 is only a 3 terminal device, it is not possible to provide true remote sensing of output voltage at the load. The best load regulation is achieved when the bottom side of R2 is connected to the load and the top side of R1 is connected directly to the case or the Vout pin of the regulator and not to the load. It is important to note that for high current applications, this can represent a significant percentage of the overall load regulation and one must keep the path from the regulator to the load as short as possible to minimize this effect.

Stability

The PL1084 requires the use of an output capacitor as part of the frequency compensation in order to make the regulator stable. For most applications, a minimum of 10 μ F aluminum electrolytic capacitor insures both stability and good transient response.

Thermal Design

The PL1084 incorporates an internal shutdown that protects the device when the junction temperature exceeds the maximum allowable junction temperature. Although this device can operate with junction temperatures in the range of 150°C, it is recommended that the selected heat sink be chosen such that during maximum continuous load operation, the junction temperature is kept below the temperature.

Layout Consideration

The output capacitors must be located as close to the Vout terminal of the device as possible. It is recommended to use a section of a layer of the PC board as a plane to connect the Vout pin to the output capacitors to prevent any high frequency oscillation that may result due to excess trace inductance.

Characteristic Curves

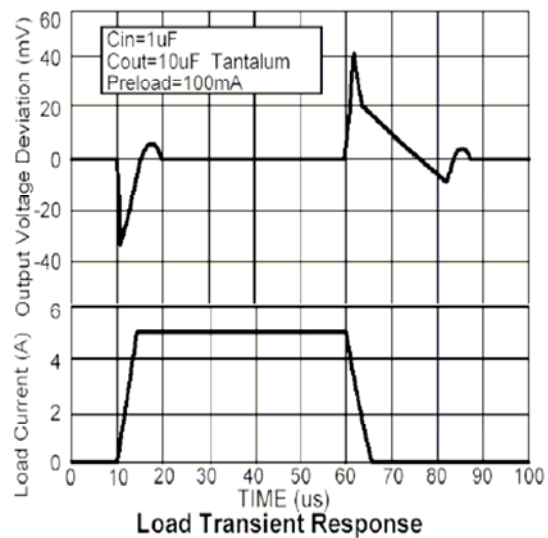
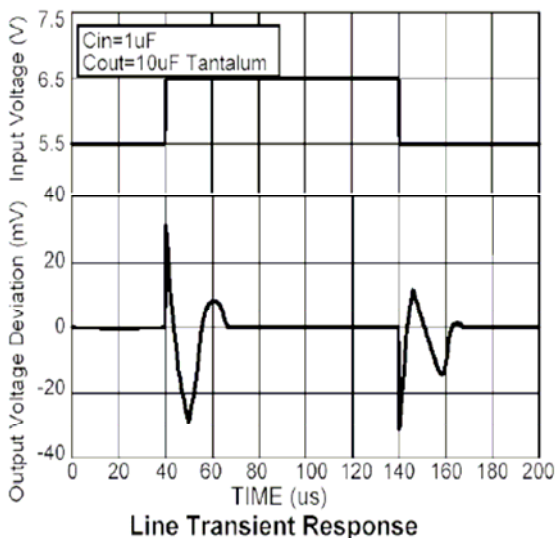
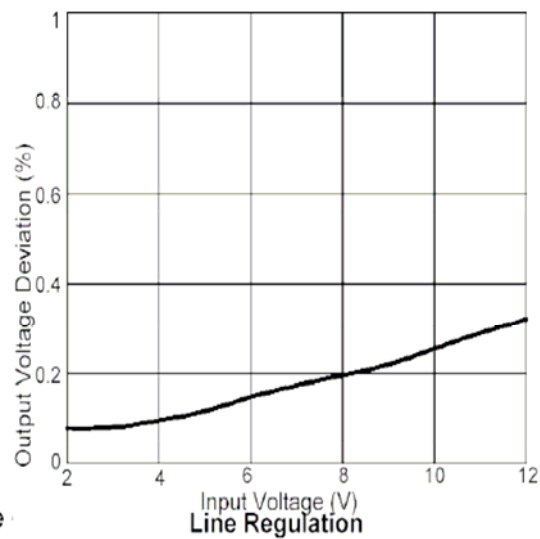
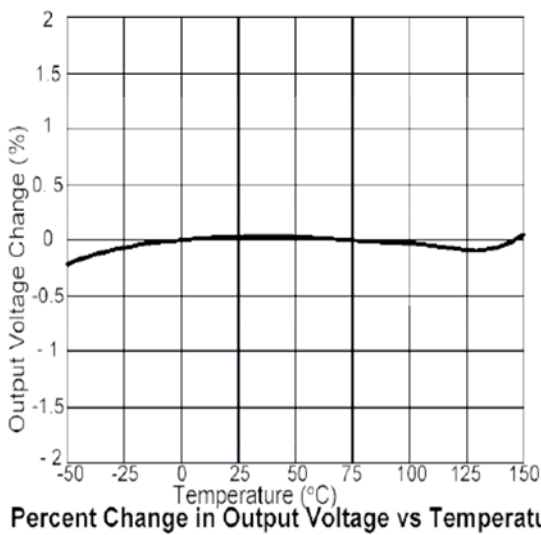
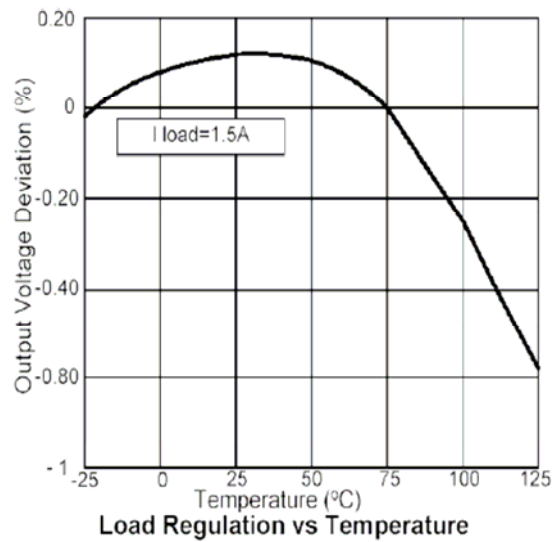
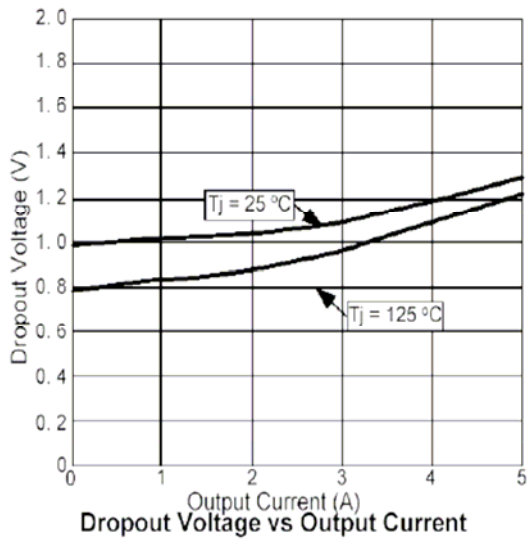

TO-252 Dimension

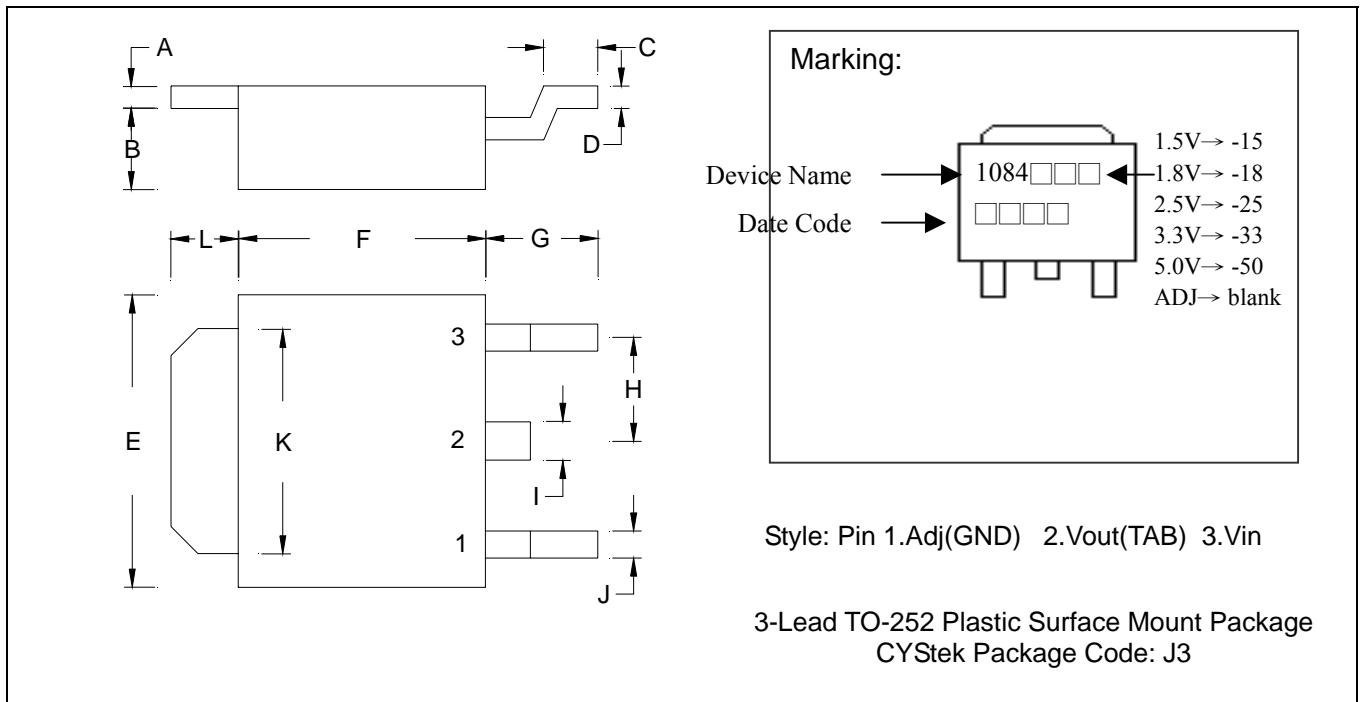

*: Typical

DIM	Inches		Millimeters		DIM	Inches		Millimeters	
	Min.	Max.	Min.	Max.		Min.	Max.	Min.	Max.
A	0.0177	0.0217	0.45	0.55	G	0.0866	0.1102	2.20	2.80
B	0.0650	0.0768	1.65	1.95	H	-	*0.0906	-	*2.30
C	0.0354	0.0591	0.90	1.50	I	-	0.0354	-	0.90
D	0.0177	0.0236	0.45	0.60	J	-	0.0315	-	0.80
E	0.2520	0.2677	6.40	6.80	K	0.2047	0.2165	5.20	5.50
F	0.2125	0.2283	5.40	5.80	L	0.0551	0.0630	1.40	1.60

Notes: 1.Controlling dimension: millimeters.
 2.Maximum lead thickness includes lead finish thickness, and minimum lead thickness is the minimum thickness of base material.
 3.If there is any question with packing specification or packing method, please contact your local CYStek sales office.

Material:

- Lead: 42 Alloy; solder plating
- Mold Compound: Epoxy resin family, flammability solid burning class: UL94V-0

Important Notice:

- All rights are reserved. Reproduction in whole or in part is prohibited without the prior written approval of CYStek.
- CYStek reserves the right to make changes to its products without notice.
- CYStek **semiconductor products are not warranted to be suitable for use in Life-Support Applications, or systems.**
- CYStek assumes no liability for any consequence of customer product design, infringement of patents, or application assistance.