

Three-Way Isolated Power Dividers Tapered, Ultra-Broadband

Rev. V3

Features

- Good Amplitude and Phase Balance
- High Isolation Between Output Ports
- Low VSWR, Small Size and Light Weight
- Octave, Multi-Octave and Decade Frequency Coverage
- Low Insertion Loss
- Power: 80 Watts Maximum
- Meets MIL-E-5400 Environments

Description

Power Dividers are compact stripline units with wide bandwidth and multiple outputs. Tapered line transformers and internal terminations provide low VSWR at all ports and high isolation between all output ports. Phase and amplitude tracking of all outputs is excellent due to the symmetrical designs. Combinations of three-way and two-way power dividers in one package are available for custom applications.

Outline Drawing

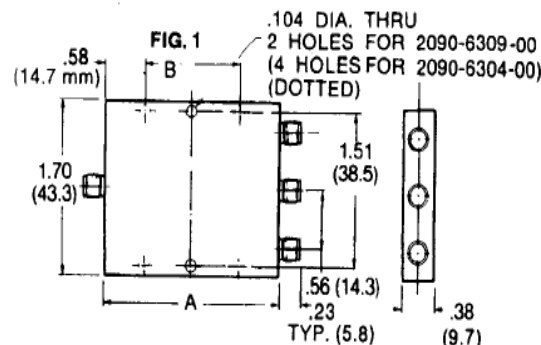

Note: All dimensions are ± 0.20 , except mounting hole diameters (± 0.005) and mounting hole location (± 0.10). Height dimension excludes rivet protrusion.

Typical Performance Part No. 2090-6309-00

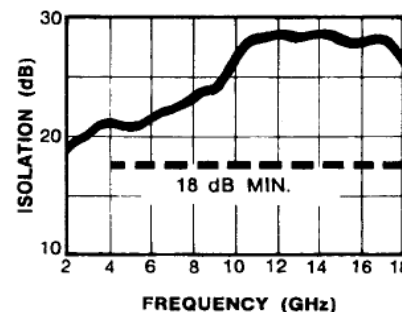
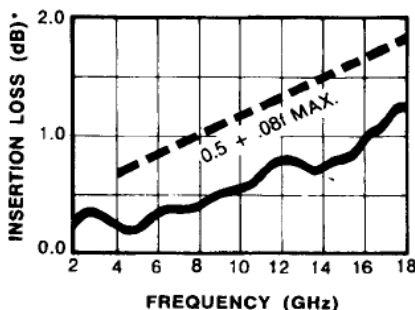
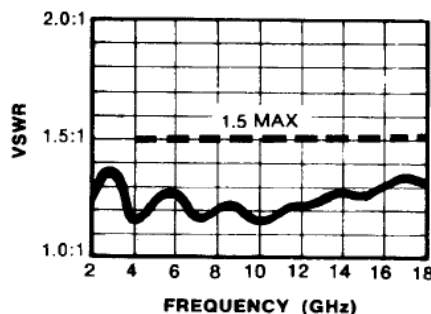

Specifications

Part Number	Freq. Range (GHz)	Insertion Loss Max (dB)	Isolation dB (min)	VSWR (max)	Output Unbalanced Amp. (dB)	Output Unbalance Phase (deg.)	Max Input Power* (watts)	Fig	Size, Inch (mm) A	Size, Inch (mm) B	Weight Oz.	Weight g
2090-6304-00	0.5-18.0	0.4 + .24f	18	1.6	0.5†	**	80	1	11.0 (280)	9.84 (250.0)	11.4	322
2090-6309-00	4.0-18.0	0.5 + 0.08f	18	1.5	0.5	**	40	1	2.02 (51.3)	—	2.1	60

* Maximum input power with output loads of VSWR $\leq 2.0:1$. Derate to 10% of listed value when arbitrarily terminated.

** Not phase matched.

† 0.5 dB (0.5 to 10 GHz), 1.0 dB (10 to 18 GHz)

Note: f is frequency in GHz.

Three-Way Isolated Power Dividers Tapered, Ultra-Broadband

Rev. V3

Features

- Octave, Multi-Octave and Decade Frequency Coverage
- Low Insertion Loss
- Excellent Amplitude and Phase Balance
- High Isolation Between Output Ports
- Low VSWR
- Power: 80 Watts Maximum
- Meets MIL-E-5400 Environments

Description

New designs include operation through 26 GHz and retain the performance of lower frequency units. These units are ideal for multioctave ECM systems, and function as either dividers or combiners to facilitate system performance.

Outline Drawing

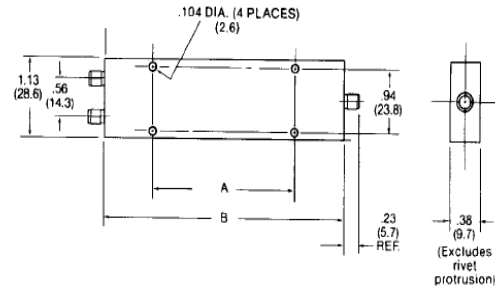

Figure 1

Note: All dimensions are ± 0.020 except mounting hole diameters (± 0.005) and mounting hole location (± 0.10).

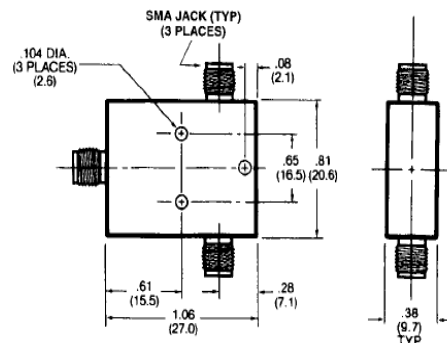

Figure 2

Specifications

Part Number	Freq. Range (GHz)	Insertion Loss Max (dB)	Isolation dB (min)	VSWR (max)	Output Un-balanced Amp. (dB)	Output Un-balance Phase (deg.)	Max Input Power** (watts)	Size, Inch (mm) A	Size, Inch (mm) B	Weight Fig.	Weight oz. g
2090-6204-00	0.5 - 18.0	0.2 + 0.17f	20 (0.5 to 3) GHz 23 (3 to 18) GHz	1.35 (0.5 to 11) GHz 1.50 (11 to 18) GHz	0.3	5	80	9.40 (239)	11.02 (291)	1	8.0 226
2090-6205-00	2.0 - 18.0	0.2 + 0.07f	18 (2 to 3) GHz 23 (3 to 18) GHz	1.35 (2 to 11) GHz 1.50 (11 to 18) GHz	0.3	5	40	2.40 (61.1)	4.02 (102)	1	2.9 83
2090-6210-00*	8.0 - 18.0	0.2 + 0.03f	18	1.50	0.3	5	20	—	—	2	1.1 30

* To 18GHz

** Maximum input power with output loads of VSWR ≤ 2.01 derate to 10% of listed value when arbitrarily terminated.

Note: f is frequency in GHz

Features

- Broadband Performance 1.0 -18.0 GHz
- Low Insertion Loss
- Excellent Amplitude and Phase Balance
- Power: 50 Watts Maximum
- Meets MIL-E-5400 Environments

Description

These are the smallest in-phase isolation 1.0 -18.0 GHz power dividers available. Rugged stripline construction, housed in sealed lightweight packages insure reliable operation in the roughest environments. SMA stainless steel connectors are standard. Contact the factory for other connector designs.

Outline Drawing

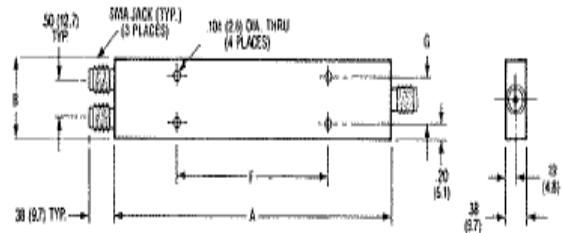

Typical Performance Part No. 2090-6214-00

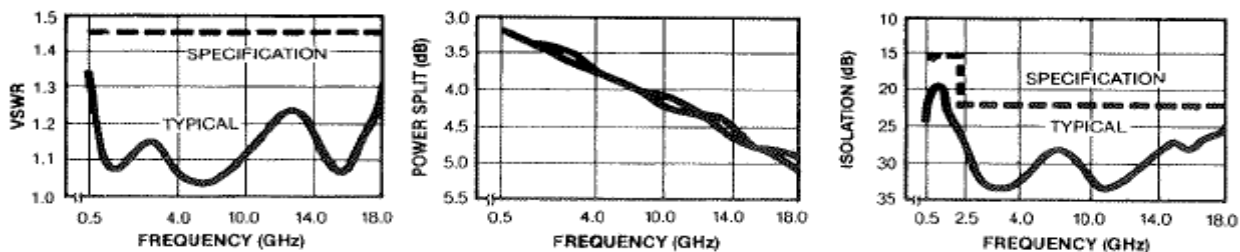

Specifications

Part Number	NO. of Outputs	Frequency Range (GHz)	VSWR (max.) Input/Output	Isolation (dB min.) Frequency (GHz) 1.0-2.5/2.5-18.0	Insertion Loss dB (max.)	Output Unbalance Phase (deg.) 1.0-2.5/2.5-18.0 GHz	Output Unbalance Amp (dB.) 1.0-2.5/2.5-18.0 GHz	Max. Input Power * (watts)
2090-6214-00	2	1.0 - 18.0	1.40/1.35	15/22	0.25 + 0.11f	5/5	0.4/0.4	50
2090-6414-00	4	1.0 - 18.0	1.6/1.4	14/18	0.6 + 0.20f	8/12	0.6/1.0	50
2090-6814-00	8	1.0 - 18.0	1.7/1.5	14/17	1.0 + 0.25f	10/16	0.8/1.4	50

* 50 Watts with 1.2:1 max. load VSWR.
25 Watts with 2:1 max. load VSWR.

Mechanical Specifications

Part Number	Size, Inch(mm) A	Size, Inch(mm) B	Size, Inch(mm) F	Size, Inch(mm) G	Weight Oz.	Weight g
2090-6214-00	5.0 (139.7)	1.00 (25.4)	4.00 (101.5)	0.60 (15.2)	3.4	96.6
2090-6414-00	5.20 (132.1)	2.00 (50.8)	3.20 (81.3)	1.60 (45.7)	16	448
2090-6814-00	5.20 (132.1)	4.00 (101.5)	3.20 (81.3)	3.60 (91.4)	30	840

ADVANCED: Data Sheets contain information regarding a product M/A-COM Technology Solutions is considering for development. Performance is based on target specifications, simulated results, and/or prototype measurements. Commitment to develop is not guaranteed.
PRELIMINARY: Data Sheets contain information regarding a product M/A-COM Technology Solutions has under development. Performance is based on engineering tests. Specifications are typical. Mechanical outline has been fixed. Engineering samples and/or test data may be available. Commitment to produce in volume is not guaranteed.

• **North America** Tel: 800.366.2266 • **Europe** Tel: +353.21.244.6400
• **India** Tel: +91.80.4155721 • **China** Tel: +86.21.2407.1588
Visit www.macomtech.com for additional data sheets and product information.

M/A-COM Technology Solutions Inc. and its affiliates reserve the right to make changes to the product(s) or information contained herein without notice.