

High Temp Card Edge Connectors 0.156" (3.96mm) Pitch

Features:

- 0.156" (3.96mm) contact spacing by 0.200" (5.08mm) row spacing
- Accepts 0.062" (1.57mm) nominal thickness P.C. board
- High profile insulator body, 0.600" (15.24mm)
- Card slot depth of 0.330" (8.38mm)
- Contact termination options include P.C. tail, wire hole, wire wrap, 90° and extender board bends
- Single or dual row configurations
- Large variety of mounting options, flush or offset lugs
- Accepts between contact and in-contact polarizing keys
- Pre-assembled card guides are available
- RoHS Compliant & UL Certified

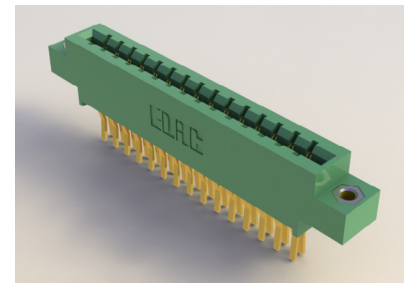

Specifications:

Insulator Material	(837: Diallyl Phthalate) (887: Polyphenylene sulfide) , UL 94V-0
Contact Material	Copper Alloy
Contact Plating	Gold Plating on mating area and Tin Plating on tails with Nickel underplating all over
Current Rating	3 amps
Contact Resistance	10 milliohms maximum
Dielectric Withstanding Voltage	1800 V AC rms at sea level between adjacent contacts
Insulation Resistance	5000 megaohms minimum
Operating Temperature	-40°C to +125°C
Insertion Force	16 oz (4.45 N) maximum per contact pair when tested with .070" (1.78mm) thick gauge
Withdrawal Force	1 oz (0.28 N) minimum per contact pair when tested with .054" (1.37mm) thick gauge

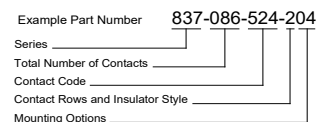

Series:	Insulator Color:	Contact Rows:	Insulator Style:	Description:
837	Green	1	Flush Mounting Lugs	Single Row
887	Black	2	Flush Mounting Lugs	Dual Row
Total Number of Contacts:		6	.170 (4.32) Offset Lugs	Single Row
006, 007, 043	Single Row	8	.170 (4.32) Offset Lugs	Dual Row
012, 014, 086	Dual Row			
Contact Code:	Description:	Tail Size:	Tail Length "G":	Mounting Options:
500	Wire Hole	.050 x .025 (1.27 x 0.64)	.260 (6.60)	01 No Mounting Lug
520	P.C. Tail	.030 x .018 (0.76 x 0.46)	.175 (4.45)	02 Ø.128" (Ø3.25mm) Mounting Holes
521	P.C. Tail	.025 Square (0.64 Square)	.150 (3.81)	03 Ø.116" (Ø2.95mm) I.D. Floating Eyelets
523	P.C. Tail	.025 Square (0.64 Square)	.390 (9.91)	04 Ø.156" (Ø3.96mm) Mounting Holes
524	P.C. Tail	.018 Square (0.46 Square)	.175 (4.45)	07 M3-0.5 Metric Threaded Inserts
540	Wire Wrap	.025 Square (0.64 Square)	.560 (14.22)	08 #4-40 Unified Threaded Inserts
541	Wire Wrap	.025 Square (0.64 Square)	.750 (19.05)	12 Ø.128" (Ø3.25mm) Side Mounting Holes
542	Wire Wrap	.025 Square (0.64 Square)	.645 (16.38)	
544	Wire Wrap	.050 x .025 (1.27 x 0.64)	.750 (19.05)	
555	EXTENDER BOARD BEND	(Code 500 Contacts)		
556	EXTENDER BOARD BEND	(Code 520 Contacts)		
558	90 DEGREE BEND	(Code 541 Contacts)		
559	90 DEGREE BEND	(Code 541 Contacts)		
560	EXTENDER BOARD BEND	(Code 523 Contacts)		

- Ordering Code Notes:**
- 1) All connector sizes up to 43 contacts single row / 86 contacts dual row are available upon request.
 - 2) For details of the extender board and 90 degree bends refer to our website.
 - 3) For lugless connectors, code 01 mounting, specify contact row code 1 or 2.
 - 4) For details of the mounting options refer to next pages.

High Temp Card Edge Connectors 0.156" (3.96mm) Pitch

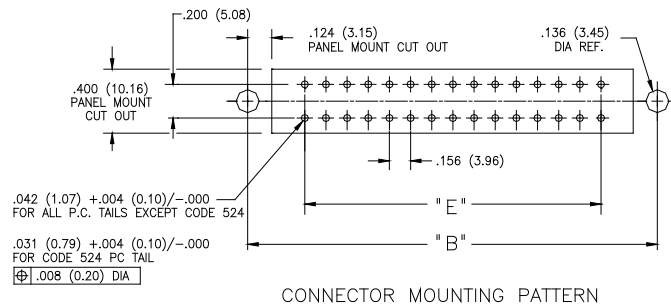
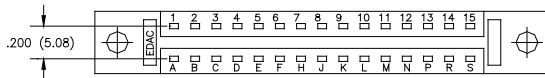
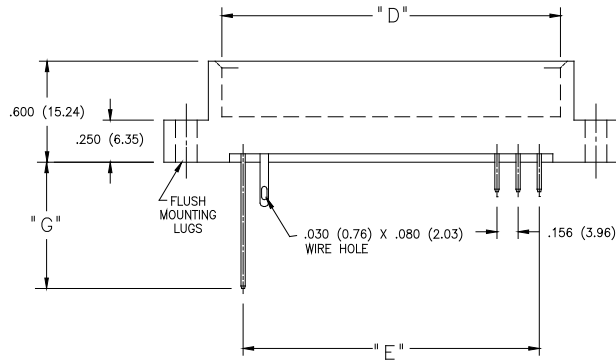
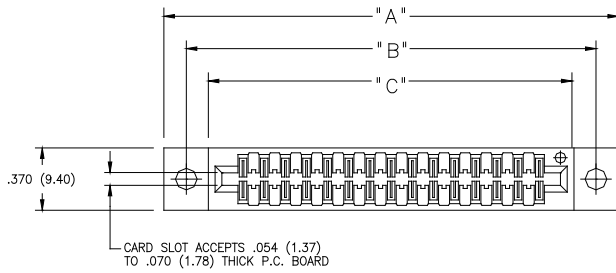

CONNECTOR MOUNTING PATTERN

SECTIONS THROUGH CONTACT POSITION

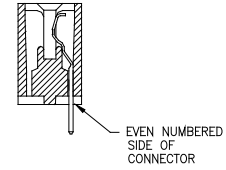

SINGLE ROW

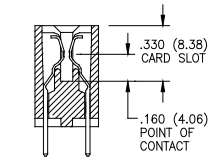
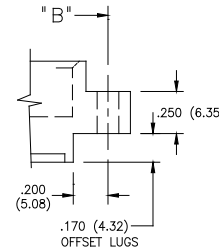

DUAL ROW

IN-CONTACT POLARIZING KEY

P/N 345-240-328



BETWEEN CONTACT POLARIZING KEY

P/N 306-240-318

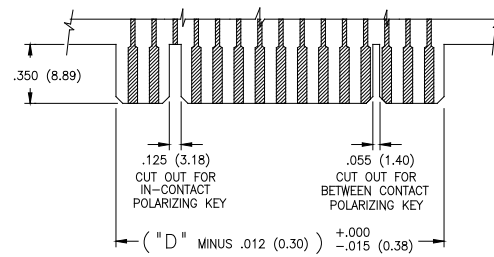

RECOMMENDED DAUGHTER BOARD

NUMBER OF CONTACTS		"A"		"B"		"C"		"D"		"E"	
Single	Double	Inch	mm	Inch	mm	Inch	mm	Inch	mm	Inch	mm
6	12	1.842	46.79	1.532	38.91	1.246	31.65	1.100	27.94	0.780	19.81
10	20	2.466	62.64	2.156	54.76	1.870	47.50	1.724	43.79	1.404	35.66
12	24	2.778	70.56	2.468	62.69	2.182	55.42	2.036	51.71	1.716	43.59
15	30	3.246	82.45	2.936	74.57	2.650	67.31	2.504	63.60	2.184	55.47
18	36	3.714	94.34	3.404	86.46	3.118	79.20	2.972	75.49	2.652	67.36
22	44	4.338	110.19	4.028	102.31	3.742	95.05	3.596	91.34	3.276	83.21
25	50	4.806	122.07	4.496	114.20	4.210	106.93	4.064	103.23	3.744	95.10
26	52	4.962	126.03	4.652	118.16	4.366	110.90	4.220	107.19	3.900	99.06
28	56	5.278	134.06	4.964	126.09	4.678	118.82	4.532	115.11	4.212	106.98
31	62	5.742	145.85	5.432	137.97	5.146	130.71	5.000	127.00	4.680	118.87
33	66	6.054	153.77	5.744	145.90	5.458	138.63	5.312	134.92	4.992	126.80
36	72	6.522	165.66	6.212	157.78	5.926	150.52	5.780	146.81	5.460	138.68
43	86	7.614	193.40	7.304	185.52	7.018	178.26	6.872	174.55	6.552	166.42

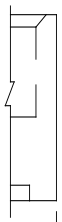

CONNECTOR "C"
DIMENSION

MOUNTING OPTION
CODE x01
(NO MOUNTING LUGS)

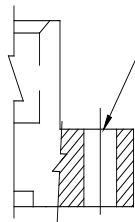

"A" DIA THROUGH HOLES

CONNECTOR "B"
DIMENSION

MOUNTING OPTION
CODES x02 AND x04
(THROUGH MOUNTING HOLES)

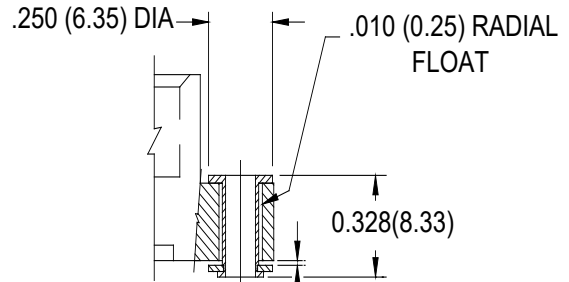

CONNECTOR "B"
DIMENSION
FLOATING EYELETS

MOUNTING OPTION
CODE x03
(FLOATING EYELETS)

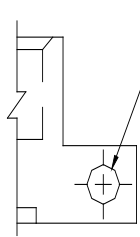

.128 (3.25) DIA THROUGH HOLES

0.125(3.18)

CONNECTOR "B"
DIMENSION

MOUNTING OPTION
CODE x12
(SIDE MOUNTING HOLES)

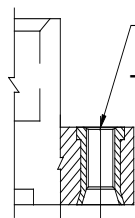

CODE x07
M3-0.5 METRIC
CODE x08
#4-40 UNC
THREADED INSERTS

CONNECTOR "B"
DIMENSION

MOUNTING OPTION
CODES x07 & x08
(THREADED INSERTS)

CODE X02 AND X04- THROUGH MTG. HOLES		
	CODE X02	CODE X04
"A" DIA.	0.128(3.25)	0.156(3.96)
CODE X07 AND X08- THREADED INSERTS		
	CODE X07	CODE X08
INSERT	M3-0.5(METRIC)	#4-40 UNC

High Temp Card Edge Connectors 0.156" (3.96mm) Pitch

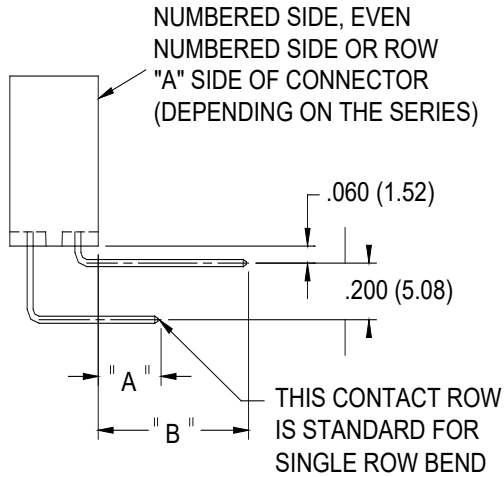

CONTACT CODE 558

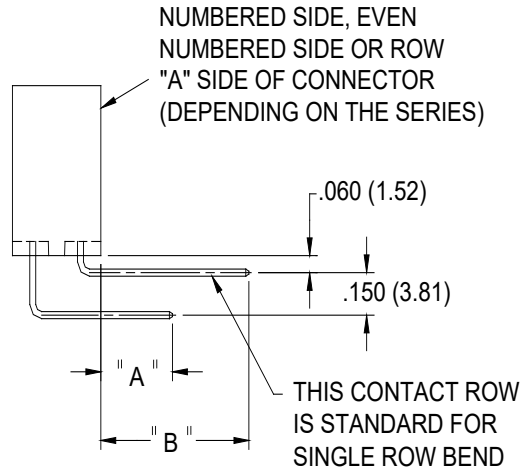

CONTACT CODE 559

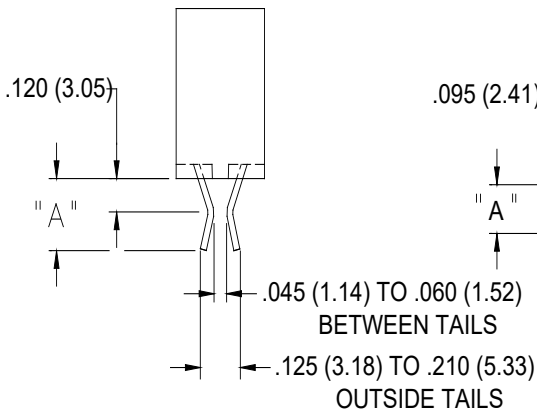

CONTACT CODE 555 BEND USES WIRE HOLE CONTACTS

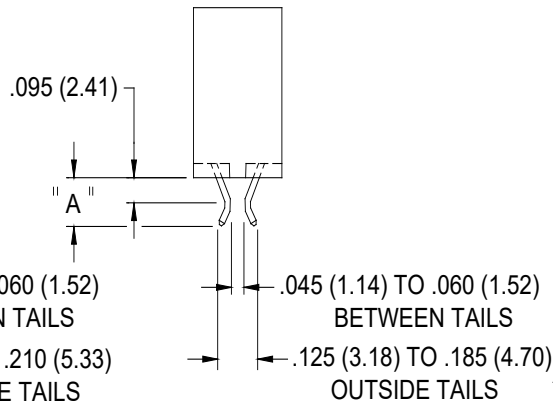

CONTACT CODE 556

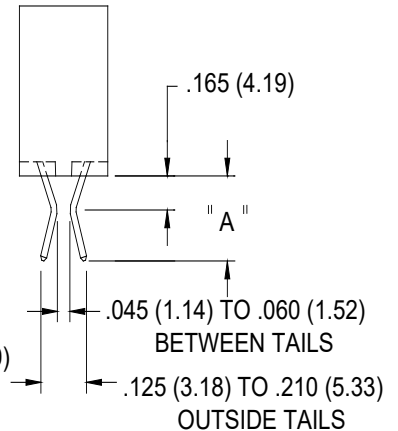

CONTACT CODE 560

MTG. OPTION	A	B
555	0.245(6.22)	
556	0.170(4.32)	
558	0.235(5.97)	0.635(16.13)
559	0.285(7.24)	0.635(16.13)
560	0.375(9.53)	

IN-CONTACT POLARIZING KEY
P/N 345-240-328

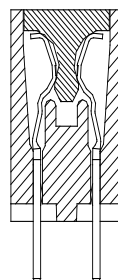

BETWEEN CONTACT POLARIZING KEY
P/N 306-240-318

