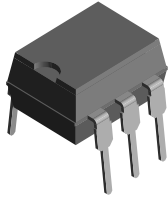
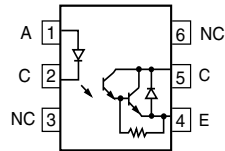


Optocoupler, Photodarlington Output, with Internal RBE



1175019



DESCRIPTION

The IL66B is an optically coupled isolator employing a gallium arsenide infrared emitter and a silicon photodarlington detector. Switching can be accomplished while maintaining a high degree of isolation between driving and load circuits. They can be used to replace reed and mercury relays with advantages of long life, high speed switching and elimination of magnetic fields.

FEATURES

- Internal RBE for high stability
- Isolation test voltage, 5300 V_{RMS}
- No base connection
- High isolation resistance
- Standard plastic DIP package
- Lead (Pb)-free component
- Component in accordance to RoHS 2002/95/EC and WEEE 2002/96/EC


RoHS
COMPLIANT

AGENCY APPROVALS

- UL1577, file no. E52744 system code H or J, double protection
- BSI IEC 60950 IEC 60065
- CSA 93751
- DIN EN 60747-5-2 (VDE 0884)/DIN EN 60747-5-5 pending available with option 1
- FIMKO

ORDER INFORMATION

PART	REMARKS
IL66B-1	CTR > 200 %, DIP-6
IL66B-2	CTR > 750 %, DIP-6
IL66B-1X006	CTR > 200 %, DIP-6 400 mil (option 6)
IL66B-2X006	CTR > 750 %, DIP-6 400 mil (option 6)
IL66B-2X009	CTR > 750 %, SMD-6 (option 9)

Note

For additional information on the available options refer to option information.

ABSOLUTE MAXIMUM RATINGS (1)

PARAMETER	TEST CONDITION	SYMBOL	VALUE	UNIT
INPUT				
Peak reverse voltage		V _R	6.0	V
Forward continuous current		I _F	60	mA
Power dissipation		P _{diss}	100	mW
Derate linearly from 55 °C			1.33	mW/°C
OUTPUT				
Collector emitter breakdown voltage		BV _{CEO}	60	V
Emitter collector breakdown voltage		BV _{ECO}	5.0	V
Power dissipation		P _{diss}	200	mW
Derate linearly from 25 °C			2.6	mW/°C

ABSOLUTE MAXIMUM RATINGS ⁽¹⁾				
PARAMETER	TEST CONDITION	SYMBOL	VALUE	UNIT
COUPLER				
Isolation test voltage	t = 1.0 s	V _{ISO}	5300	V _{RMS}
Isolation resistance	V _{IO} = 500 V, T _{amb} = 25 °C	R _{IO}	≥ 10 ¹²	Ω
	V _{IO} = 500 V, T _{amb} = 100 °C	R _{IO}	≥ 10 ¹¹	Ω
Total dissipation		P _{tot}	250	mW
Derate linearly	from 25 °C		3.3	mW/°C
Creepage path			7	min mm
Clearance path			7	min mm
Storage temperature		T _{stg}	- 55 to + 150	°C
Operating temperature		T _{amb}	- 55 to + 100	°C
Solder Temperature ⁽²⁾	10 s	T _{slid}	260	°C

Notes

⁽¹⁾ T_{amb} = 25 °C, unless otherwise specified

Stresses in excess of the absolute maximum ratings can cause permanent damage to the device. Functional operation of the device is not implied at these or any other conditions in excess of those given in the operational sections of this document. Exposure to absolute maximum ratings for extended periods of the time can adversely affect reliability.

⁽²⁾ Refer to reflow profile for soldering conditions for surface mounted devices (SMD). Refer to wave profile for soldering conditions for through hole devices (DIP).

ELECTRICAL CHARACTERISTICS						
PARAMETER	TEST CONDITION	SYMBOL	MIN.	TYP.	MAX.	UNIT
INPUT						
Forward voltage	I _F = 10 mA	V _F		1.25	1.5	V
Reverse current	V _R = 3.0 V	I _R		0.01	100	μA
Capacitance	V _R = 0	C _O		25		pF
OUTPUT						
Collector emitter breakdown voltage	I _C = 100 μA	BV _{CEO}	60			V
Collector emitter leakage current	V _{CE} = 50 V, I _F = 0 A	I _{CEO}		1.0	100	nA
COUPLER						
Saturation voltage	I _C = 10 mA	V _{CEsat}			1.0	V

Note

T_{amb} = 25 °C, unless otherwise specified

Minimum and maximum values are testing requirements. Typical values are characteristics of the device and are the result of engineering evaluation. Typical values are for information only and are not part of the testing requirements.

CURRENT TRANSFER RATIO							
PARAMETER	TEST CONDITION	PART	SYMBOL	MIN.	TYP.	MAX.	UNIT
Current transfer ratio	I _F = 2.0 mA, V _{CE} = 5.0 V	IL66B-1	CTR	200			%
		IL66B-2	CTR	750	1000		%

SWITCHING CHARACTERISTICS						
PARAMETER	TEST CONDITION	SYMBOL	MIN.	TYP.	MAX.	UNIT
Turn-On, Turn-Off time	V _{CC} = 10 V, I _F = 2 mA, R _L = 100 Ω	t _{on} , t _{off}			200	μs

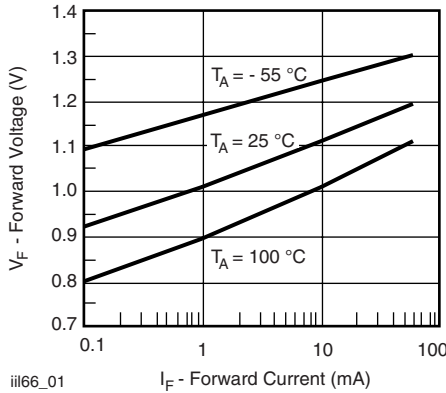
TYPICAL CHARACTERISTICS
 $T_{amb} = 25\text{ }^{\circ}\text{C}$, unless otherwise specified


Fig. 3 - Forward Voltage vs. Forward Current

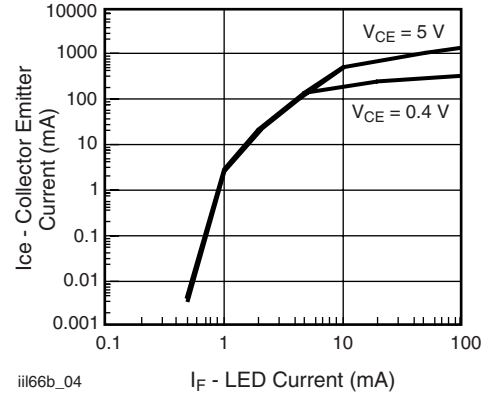


Fig. 6 - Non-Saturated and Saturated Collector Emitter Current vs. LED Current

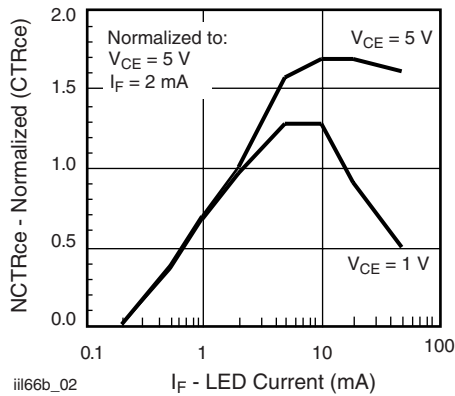
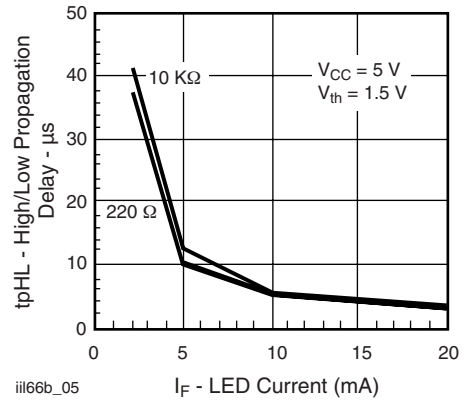

 Fig. 4 - Normalized Non-Saturated and Saturated CTR_{CE} vs. LED Current


Fig. 7 - High to low Propagation Delay vs. Collector Load Resistance and LED Current

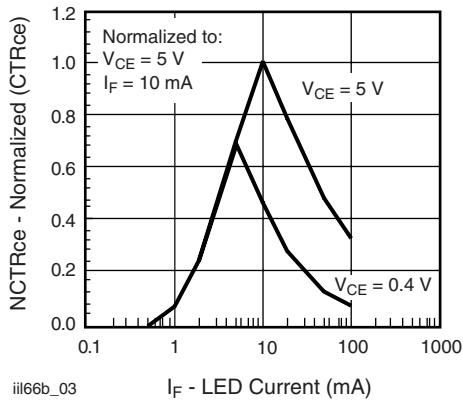
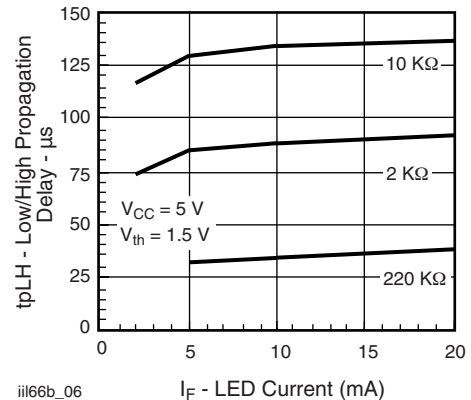

 Fig. 5 - Normalized Non-Saturated and Saturated CTR_{CE} vs. LED Current


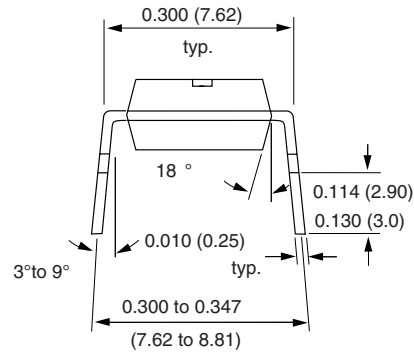
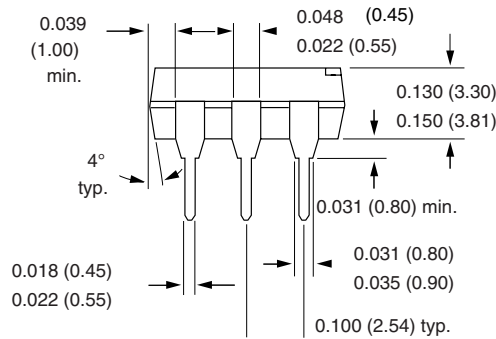
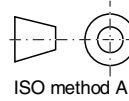
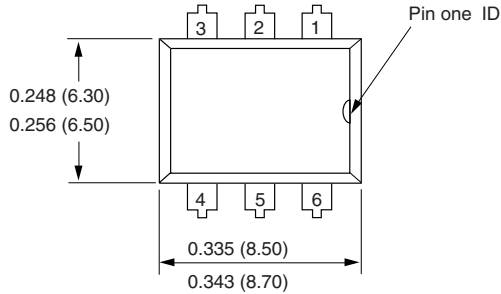
Fig. 8 - Low to High Propagation Delay vs. Collector Load Resistance and LED Current

IL66B

Vishay Semiconductors Optocoupler, Photodarlington Output,
with Internal RBE

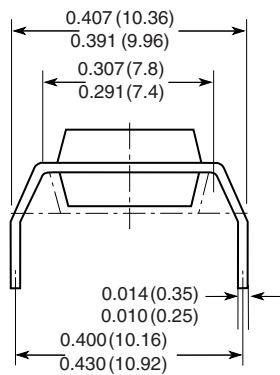


PACKAGE DIMENSIONS in inches (millimeters)



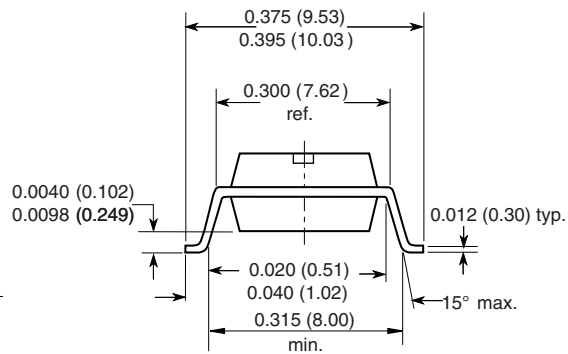
i178004

Option 6



18493

Option 9



**OZONE DEPLETING SUBSTANCES POLICY STATEMENT**

It is the policy of Vishay Semiconductor GmbH to

1. Meet all present and future national and international statutory requirements.
2. Regularly and continuously improve the performance of our products, processes, distribution and operating systems with respect to their impact on the health and safety of our employees and the public, as well as their impact on the environment.

It is particular concern to control or eliminate releases of those substances into the atmosphere which are known as ozone depleting substances (ODSs).

The Montreal Protocol (1987) and its London Amendments (1990) intend to severely restrict the use of ODSs and forbid their use within the next ten years. Various national and international initiatives are pressing for an earlier ban on these substances.

Vishay Semiconductor GmbH has been able to use its policy of continuous improvements to eliminate the use of ODSs listed in the following documents.

1. Annex A, B and list of transitional substances of the Montreal Protocol and the London Amendments respectively.
2. Class I and II ozone depleting substances in the Clean Air Act Amendments of 1990 by the Environmental Protection Agency (EPA) in the USA
3. Council Decision 88/540/EEC and 91/690/EEC Annex A, B and C (transitional substances) respectively.

Vishay Semiconductor GmbH can certify that our semiconductors are not manufactured with ozone depleting substances and do not contain such substances.

We reserve the right to make changes to improve technical design
and may do so without further notice.

Parameters can vary in different applications. All operating parameters must be validated for each customer application by the customer. Should the buyer use Vishay Semiconductors products for any unintended or unauthorized application, the buyer shall indemnify Vishay Semiconductors against all claims, costs, damages, and expenses, arising out of, directly or indirectly, any claim of personal damage, injury or death associated with such unintended or unauthorized use.

Vishay Semiconductor GmbH, P.O.B. 3535, D-74025 Heilbronn, Germany



Disclaimer

All product specifications and data are subject to change without notice.

Vishay Intertechnology, Inc., its affiliates, agents, and employees, and all persons acting on its or their behalf (collectively, "Vishay"), disclaim any and all liability for any errors, inaccuracies or incompleteness contained herein or in any other disclosure relating to any product.

Vishay disclaims any and all liability arising out of the use or application of any product described herein or of any information provided herein to the maximum extent permitted by law. The product specifications do not expand or otherwise modify Vishay's terms and conditions of purchase, including but not limited to the warranty expressed therein, which apply to these products.

No license, express or implied, by estoppel or otherwise, to any intellectual property rights is granted by this document or by any conduct of Vishay.

The products shown herein are not designed for use in medical, life-saving, or life-sustaining applications unless otherwise expressly indicated. Customers using or selling Vishay products not expressly indicated for use in such applications do so entirely at their own risk and agree to fully indemnify Vishay for any damages arising or resulting from such use or sale. Please contact authorized Vishay personnel to obtain written terms and conditions regarding products designed for such applications.

Product names and markings noted herein may be trademarks of their respective owners.