

**PLEASE CHECK WWW.MOLEX.COM FOR LATEST PART INFORMATION**

**Part Number:** [0717434040](#)  
**Status:** **Active**  
**Description:** 1.27mm (.050") Pitch EBBI™ 50D Receptacle, Vertical SCA-2, 40 Circuits, SMT, 2.49mm (.098") Retention Clip

**Documents:**

[3D Model](#) [Product Specification PS-73826-0000 \(PDF\)](#)  
[Drawing \(PDF\)](#) [RoHS Certificate of Compliance \(PDF\)](#)

**Agency Certification**

CSA LR19980  
 UL E29179

**General**

Product Family PCB Receptacles  
 Series [71743](#)  
 Application Board-to-Board  
 Comments Circuits 21-23, 26, 29, 32, 35-40 are advanced terminals for sequential first-mate/last-break mating  
 Product Name EBBI™, SCA-2

**Physical**

Circuits (Loaded) 40  
 Color - Resin Black  
 Durability (mating cycles max) 500  
 Flammability 94V-0  
 Glow-Wire Compliant No  
 Guide to Mating Part Yes  
 Lock to Mating Part None  
 Material - Metal Phosphor Bronze  
 Material - Plating Mating Gold  
 Material - Plating Termination Tin  
 Material - Resin High Temperature Thermoplastic  
 Number of Rows 2  
 Orientation Vertical  
 PCB Locator Yes  
 PCB Retention Yes  
 PCB Thickness Recommended (in) 0.062 In  
 PCB Thickness Recommended (mm) 1.60 mm  
 Packaging Type Tray  
 Pitch - Mating Interface (in) 0.050 In  
 Pitch - Mating Interface (mm) 1.27 mm  
 Plating min: Mating (µin) 30  
 Plating min: Mating (µm) 0.76  
 Plating min: Termination (µin) 75  
 Plating min: Termination (µm) 1.91  
 Polarized to PCB Yes  
 Surface Mount Compatible (SMC) N/A  
 Temperature Range - Operating -40°C to +105°C  
 Termination Interface: Style Surface Mount

**Electrical**

Current - Maximum per Contact 1A  
 Voltage - Maximum 30V

**Solder Process Data**

Lead-free Process Capability SMC & Wave Capable (TH only)

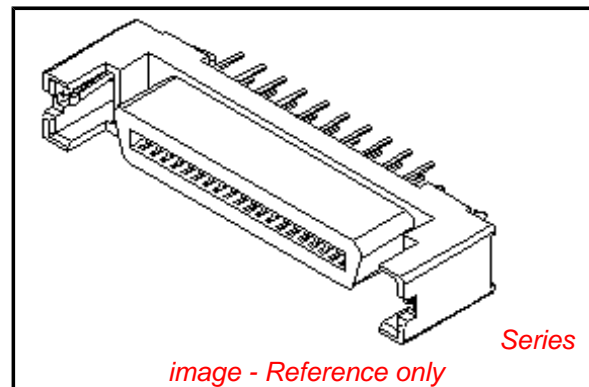

**EU RoHS**

**ELV and RoHS Compliant**  
**REACH SVHC**  
 Not Reviewed  
**Halogen-Free Status**  
**Not Reviewed**

**China RoHS**



**Need more information on product environmental compliance?**

Email [productcompliance@molex.com](mailto:productcompliance@molex.com)  
 For a multiple part number RoHS Certificate of Compliance, [click here](#)

Please visit the [Contact Us](#) section for any non-product compliance questions.

**Search Parts in this Series**

[71743Series](#)

**Mates With**

[87572](#) , [87571](#) , [87012](#)

Process Temperature max. C 260

**Material Info**

**Reference - Drawing Numbers**

Product Specification PS-73826-0000  
Sales Drawing SD-71743-003

This document was generated on 04/14/2010

**PLEASE CHECK [WWW.MOLEX.COM](http://WWW.MOLEX.COM) FOR LATEST PART INFORMATION**

13 12 11 10 9 8 7 6 5 4 3 2 1

- NOTES: 1. MATERIAL:  
 HOUSING: I.R. COMPATIBLE POLYMER, GLASS FILLED, UL 94 V 0, BLACK  
 TERMINALS: COPPER ALLOY  
 BOARDLOCK: COPPER ALLOY
2. FINISH:  
 TERMINALS: 30 MICROINCHES / 0.76 MICROMETERS GOLD IN CONTACT AREA  
 100 MICROINCHES/ 2.54 MICROMETERS TIN IN TAIL AREA  
 NICKEL UNDERPLATE OVERALL.  
 ESD BOARDLOCK: TIN OVER NICKEL OVERALL.  
 \*THE PRIMARY SHIPPING CARTON WILL BE LABELED 'COMPLIANT TO  
 RoHS DIRECTIVE 2002/95/EC AND ELV ANNEX II OF DIRECTIVE 2000/53/EC'.  
 CARTONS WITHOUT THIS LABEL MAY CONTAIN PRODUCT WITH LEAD.
3. PRODUCT SPECIFICATION: PS-73826-0000
4. FOUR DIGIT DATE CODE IN THIS LOCATION (WK YR).
5. CONTACT GAP WILL ACCOMMODATE MATING CONNECTOR OF:  
 .063+/-0.003 / 1.60+/-0.08
6. PACKAGE PER SPECIFICATION PK-70873-5025.
7. CIRCUIT NUMBERS 1,36 THRU 43, 45, 46, AND 75 THRU 80,  
 ARE ADVANCED (LONG) TERMINALS FOR SEQUENTIAL MATING.
8. COPLANARITY TO BE MEASURED USING FIXTURE \* 71743-9001 OR EQUIVALENT.  
 MEASUREMENT TO BE TAKEN AT 50X MAGNIFICATION.  
 COPLANARITY IS THE DISTANCE BETWEEN THE SEATING PLANE AND THE LOWEST  
 POINT ON THE SMT TAIL THAT IS FARTHEST AWAY FROM THE SEATING PLANE.  
 FIXTURING TO BE SUCH THAT ALL TAILS ARE OVER THE SEATING PLANE.

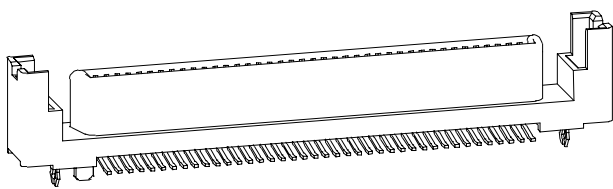
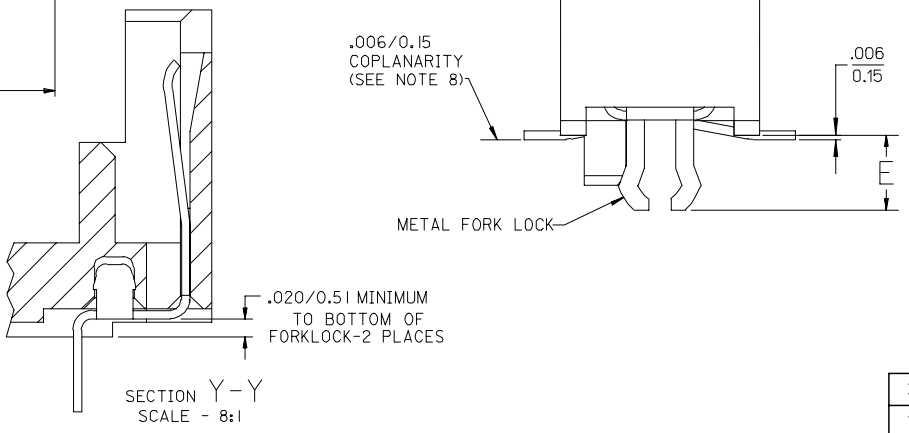
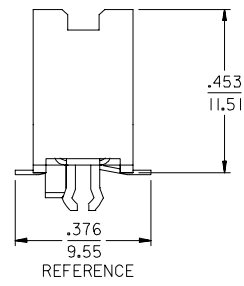
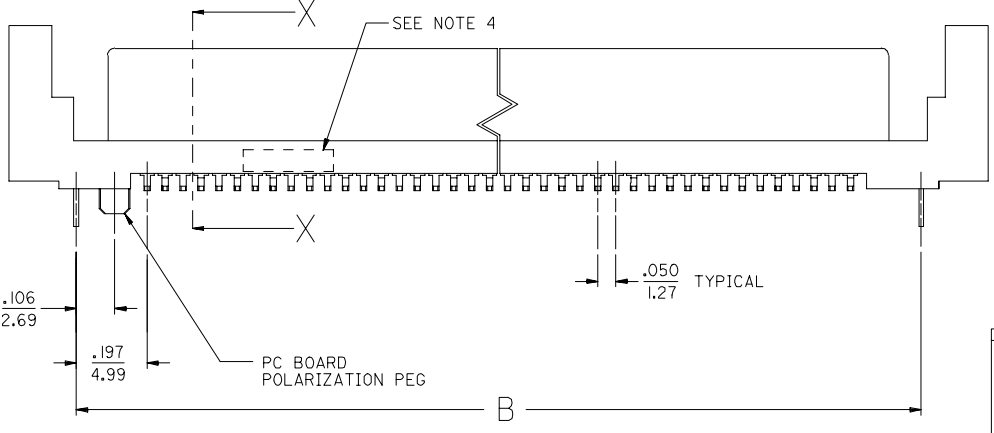
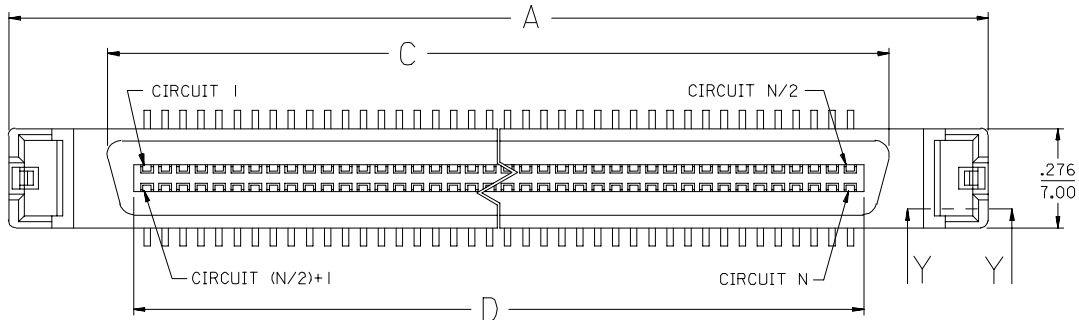

2	E
1	E
SHT	REV

ADD PART NUMBERS EC NO: UCP2006-0819 DRAWN: BBARKER CHKD: SMILLER APPR: SMILLER 2005/10/20 2005/10/21 2005/10/21	QUALITY SYMBOLS ▽=0 ▽=0	GENERAL TOLERANCES (UNLESS SPECIFIED)		DIMENSION STYLE IN/MM		SCALE 4:1	DESIGN UNITS INCH	THIRD ANGLE PROJECTION	
		4 PLACES ± .010 3 PLACES ± .010 2 PLACES ± 0.25 1 PLACE ± .010	mm INCH	DRAWN BY RLWHITE	DATE 03/05/15	TITLE SALES DRAWING - ASSEMBLY EBBI VERTICAL RECEPTACLE SMT SCA-2 CONNECTOR			
		ANGULAR ±1/2°	MATERIAL NO. SEE CHART	CHECKED BY BBARKER	DATE 03/05/15	MOLEX INCORPORATED			
		DRAFT WHERE APPLICABLE MUST REMAIN WITHIN DIMENSIONS	SIZE C	DOCUMENT NO. SD-71743-003		SHEET NO. 1 OF 2			

12 11 10 9 8 7 6 5 4 3 2 1

	13	12	11	10	9	8	7	6	5	4	3	2	1
	MATERIAL NUMBER		DIMENSION E	CIRCUIT SIZE (N)	DIMENSION A	DIMENSION B	DIMENSION C	DIMENSION D	DIMENSION F	ADVANCED TERMINALS / CIRCUITS (SECTION Z-Z, SHEET I)			
J	71743-4040		.098/2.49	40	1.717/43.61	1.343/34.11	1.168/29.67	1.025/26.04	.950/24.13	21, 22, 23, 26, 29, 32, 35, 36, 37, 38, 39, 40			
	71743-4240		.118/3.00										
I	71743-4080		.098/2.49	80	2.717/69.01	2.343/59.51	2.168/55.07	2.025/51.44	1.950/49.53	1, 36, 37, 38, 39, 40, 41, 42, 43, 45, 46, 75, 76, 77, 78, 79, 80			
	71743-4280		.118/3.00										

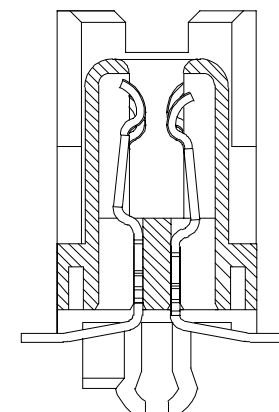
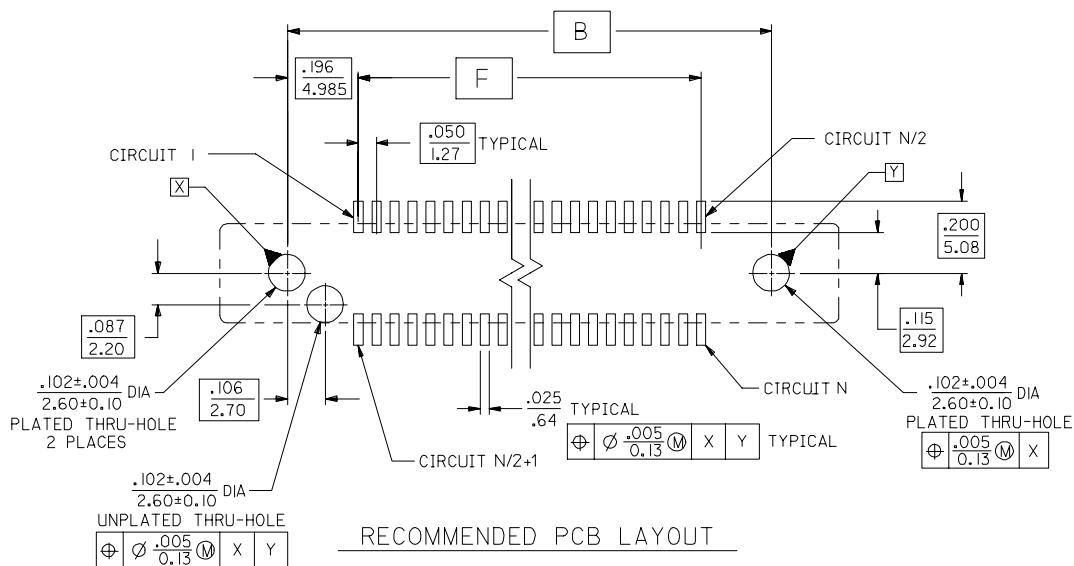

SECTION X-X  
SCALE - 8:1

ADD PARTS EC NO: UCP2006-0819 2005/10/20 DRAWN: BBARKER 2005/10/21 CHKD: HSWART 2005/10/21 APPR: SMILLER 2005/10/21 REV:	GENERAL TOLERANCES (UNLESS SPECIFIED)		DIMENSION STYLE IN/MM		SCALE 4:1	DESIGN UNITS INCH	THIRD ANGLE PROJECTION
	4 PLACES ± --- ± ---	3 PLACES ± --- ± .010	2 PLACES ± 0.25 ± ---	1 PLACE ± --- ± ---	DRAWN BY RWHITE	DATE 03/05/15	TITLE SALES DRAWING - ASSEMBLY EBBI VERTICAL RECEPTACLE SMT SCA-2 CONNECTOR
	ANGULAR ±1/2°				CHECKED BY BBARKER	DATE 03/05/15	MOLEX INCORPORATED DOCUMENT NO. SD-71743-003 SHEET NO. 2 OF 2
	DRAFT WHERE APPLICABLE MUST REMAIN WITHIN DIMENSIONS				APPROVED BY SMILLER	DATE 03/05/15	
MATERIAL NO.		SEE CHART		MATERIAL NO.		SHEET NO.	
						2 OF 2	