

1	2	3	4	5	6	7	8
编号	修改原因	制图	审核	批准			

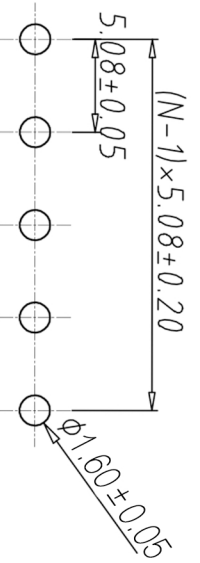
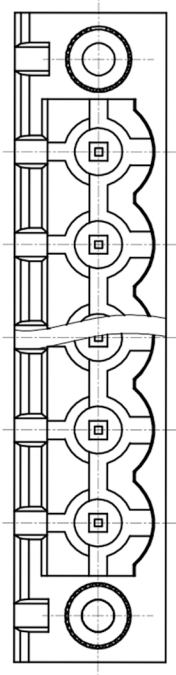
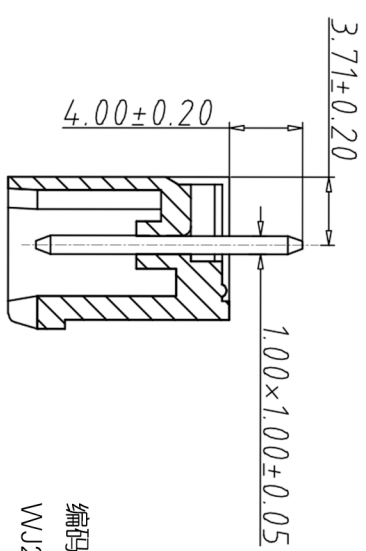
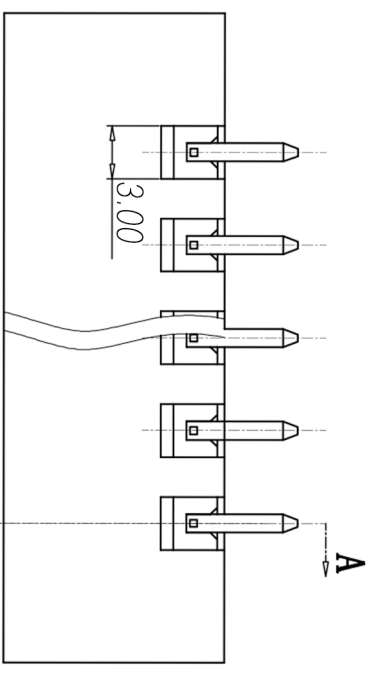
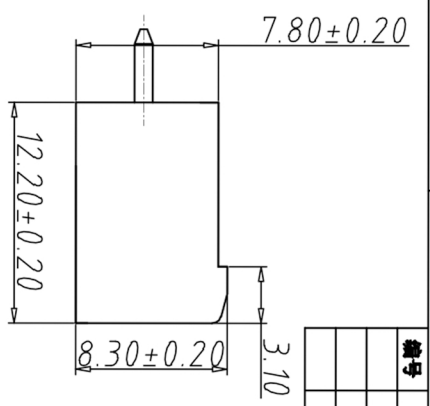
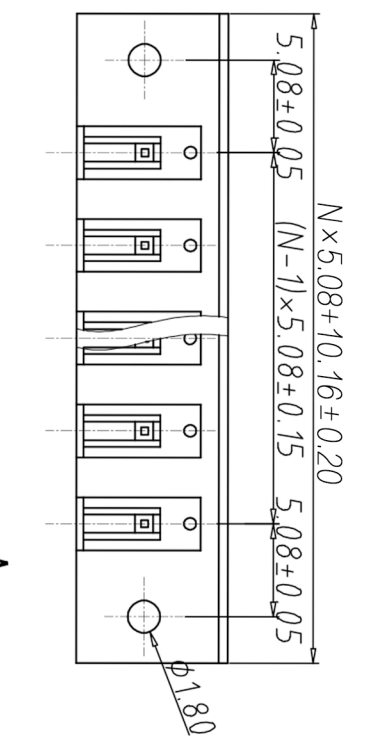

- 材质&电镀  
螺母: M2.5, 黄铜  
焊针: 黄铜, 镀锡  
塑件: PA66, UL 94V-0
- 电气性能  
参考标准 UL IEC  
额定电压: 300V 450V  
额定电流: 15A 20A
- 机械性能  
绝缘电阻: 500MΩ / DC500V  
耐电压: AC2000V/1min  
温度范围: -40°C ~ +105°C  
瞬时温度: +250°C for 5 Sec

SECTION A-A

编码原则:

WJ2EDGVM-5.08

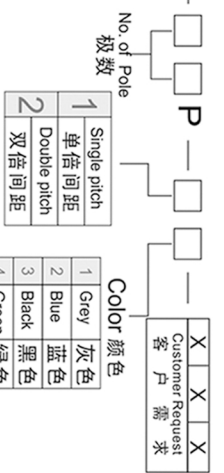

尺寸公差:	角度公差:
X, ±0.20	X, ±2°
.X, ±0.15	.X, ±1.5'
.XX, ±0.10	.XX, ±1'
图纸类型	客户图纸
比例	1:1
图页	1\1
图底编号	

投影法

单位 mm

品名 嵌式接线端子 规格: 08MM

产品系列 WJ2EDGVM 系列

**WV** 宁波康奈克斯电气有限公司  
Ningbo Kangnex Electric Co., Ltd