

PLEASE CHECK WWW.MOLEX.COM FOR LATEST PART INFORMATION

Part Number: [0250020403](#)
Status: **Active**
Overview: ribbon_cable_jumpers
Description: 2.54mm (.100") Pitch Board-to-Board Ribbon Cable Jumper - 24 AWG, Stranded Topcoat, 4 Circuits, Strip and Retain, 0.076m (3.00") Length

Documents:

[Drawing \(PDF\)](#) [RoHS Certificate of Compliance \(PDF\)](#)

General

Product Family	Cable
Series	25002
Crimp Quality Equipment	Yes
Geographic Area	Asia
Overview	ribbon_cable_jumpers
Product Name	Ribbon

Physical

Cable Length	0.076m (3.00")
Circuits (Loaded)	4
Circuits (maximum)	4
Insulation	PVC
Packaging Type	Bag
Pitch - Term. Interface (in)	0.100 In
Pitch - Term. Interface (mm)	2.54 mm
Temperature Range - Operating	-20°C to +105°C
Wire Size AWG	24
Wire/Cable Type	(7x32) Stranded, Topcoat

Electrical

Current - Maximum per Contact	N/A
Voltage - Maximum	300V

Material Info

Reference - Drawing Numbers

Sales Drawing	SD-25002-001
---------------	--------------



EU RoHS

**ELV and RoHS
Compliant**
**REACH SVHC
Not Reviewed**
**Halogen-Free
Status
Not Reviewed**

China RoHS



**Need more information on product
environmental compliance?**

Email productcompliance@molex.com
 For a multiple part number RoHS Certificate of Compliance, [click here](#)

Please visit the [Contact Us](#) section for any non-product compliance questions.

Search Parts in this Series
[25002Series](#)

CABLE SPECIFICATIONS:

1.- STANDARD JUMPER SERIES #25002 (8997 CABLE, .125" S/R BOTH ENDS)

2.- PHYSICAL

CONDUCTOR SPACING ----- .100" (2.54mm) ϕ TO ϕ
 WIRE GAUGE ----- 24 AWG (7/32), TOPCOAT
 INSULATION ----- GRAY PVC
 EDGE MARK COLOR ----- RED

3.- AGENCY

U.L. STYLE ----- 2651
 TEMPERATURE RATING ----- -20 °C TO 105 °C
 VOLTAGE RATING ----- 300V. MAX.
 FLAMMABILITY RATING ----- VW-1

4.- SPECIAL REQUIREMENT

RoHS AND LEAD FREE COMPLIANT
 NO TEXT MARKING ON PCB

5.- GENERAL

NON-OPERATING TEMPERATURE ----- -20°C TO 105°C

6.- SOLDERING CONDITION

SOLDER TEMPERATURE ----- 260°C. MAX. $\triangle B_1$
 SOLDERING TIME ----- 3 SECONDS. MAX.
 INSULATION SHRINK ----- 2MM. NOM

PCB HOLE LAYOUT
 RECOMMENDED HOLE DIA. .037 In.

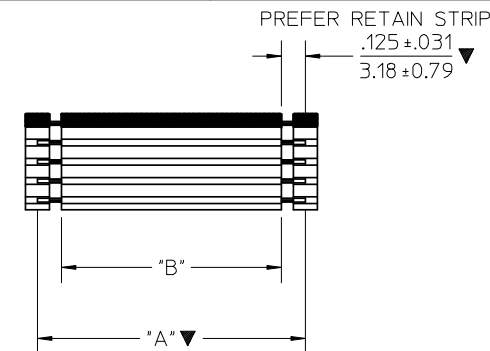
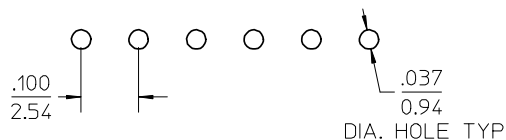

OVERALL LENGTH ("A")
 TOLERANCE FOR OAL +/- .100"
 INSULATION LENGTH ("B" REF.)
 DIMS "A" & "B" REFERS TO
 SHOWN IN MATRIX.

MATRIX FOR STANDARD JUMPERS SERIES # 25002 (8997 CABLE .125" S/R BOTH ENDS)								
LENGTH "A" (±.100")	1.250"	2.250"	3.250"	4.250"	5.250"	6.250"	7.250"	8.250"
LENGTH "B" CIRCUITS (REF)	1.000"	2.000"	3.000"	4.000"	5.000"	6.000"	7.000"	8.000"
2	25002-0201	25002-0202	25002-0203	25002-0204	25002-0205	25002-0206	25002-0207	25002-0208
3	25002-0301	25002-0302	25002-0303	25002-0304	25002-0305	25002-0306	25002-0307	25002-0308
4	25002-0401	25002-0402	25002-0403	25002-0404	25002-0405	25002-0406	25002-0407	25002-0408
5	25002-0501	25002-0502	25002-0503	25002-0504	25002-0505	25002-0506	25002-0507	25002-0508
6	25002-0601	25002-0602	25002-0603	25002-0604	25002-0605	25002-0606	25002-0607	25002-0608
7	25002-0701	25002-0702	25002-0703	25002-0704	25002-0705	25002-0706	25002-0707	25002-0708
8	25002-0801	25002-0802	25002-0803	25002-0804	25002-0805	25002-0806	25002-0807	25002-0808
9	25002-0901	25002-0902	25002-0903	25002-0904	25002-0905	25002-0906	25002-0907	25002-0908
10	25002-1001	25002-1002	25002-1003	25002-1004	25002-1005	25002-1006	25002-1007	25002-1008

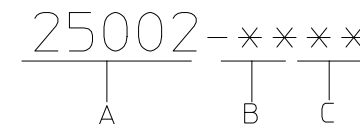

A = STD. JUMPER I.D. No

B = CIRCUIT SIZE
 2 THRU 10

C = DENOTES LENGTH
 1.000" TO 8.000"

SEE CHANGE DETAIL EC NO: THL2008-0019 DRWN: CPANSAKHOM 2007/12/07 CHKD: NCHALERM 2007/12/11 APPR: SVIRATJAPOL 2007/12/20	QUALITY SYMBOLS $\nabla=3$ $\nabla=0$	GENERAL TOLERANCES (UNLESS SPECIFIED)		DIMENSION STYLE IN/MM		SCALE NTS	DESIGN UNITS INCH	THIRD ANGLE PROJECTION	
		4 PLACES \pm --- \pm --- 3 PLACES \pm --- \pm --- 2 PLACES \pm --- \pm --- 1 PLACE \pm --- \pm --- ANGULAR \pm --- °	DRAWN BY CPANSAKHOM	DATE 2006/06/01	TITLE STANDARD JUMPER .100" CTRS PVC INSULATED 24 AWG TOPCOATED		MOLEX MOLEX INCORPORATED	DOCUMENT NO. SD-25002-001	SHEET NO. 1 OF 1
DRAFT WHERE APPLICABLE MUST REMAIN WITHIN DIMENSIONS		SEE CHART		THIS DRAWING CONTAINS INFORMATION THAT IS PROPRIETARY TO MOLEX INCORPORATED AND SHOULD NOT BE USED WITHOUT WRITTEN PERMISSION					