

AZ DISPLAYS, INC.

COMPLETE LCD SOLUTIONS

6.4" VGA Very High Brightness TFT-LCD

ATM6448C-NLW-FBD

(based on PVI : PD064VT2)

COLOR LIQUID CRYSTAL DISPLAY

TECHNICAL SPECIFICATION**CONTENTS**

NO.	ITEM	PAGE
-	Cover	1
-	Contents	2
1	Application	3
2	Features	3
3	Mechanical Specifications	3
4	Mechanical Drawing of TFT-LCD module	4
5	Input / Output Terminals	6
6	Absolute Maximum Ratings	7
7	Electrical Characteristics	7
8	Power On Sequence	13
9	Optical Characteristics	14
10	Handling Cautions	17
11	Reliability Test	18
12	Block Diagram	19
13	Packing Diagram	20

1. Application

This product applies computer peripheral, industrial meter, image communication, web-pad, e-books and multi-media.

2. Features

- . Pixel in stripe configuration
- . Slim and compact
- . Display Colors : 262,144 colors
- . Viewing Direction : 6 o'clock
- . Slim module design for mobile electronics device application

3. Mechanical Specifications

Parameter	Specifications	Unit
Screen Size	6.4 (diagonal)	inch
Display Format	640×R, G, B×480	dot
Active Area	129.6(H)×97.44 (V)	mm
Dot Pitch	0.0675 (H)×0.203 (V)	mm
Pixel Pitch	0.203 (H)×0.203 (V)	mm
Pixel Configuration	Stripe	
Outline Dimension	See Mechanical Drawing	mm
Weight	165±10	g

4. Mechanical Drawing of TFT-LCD Module

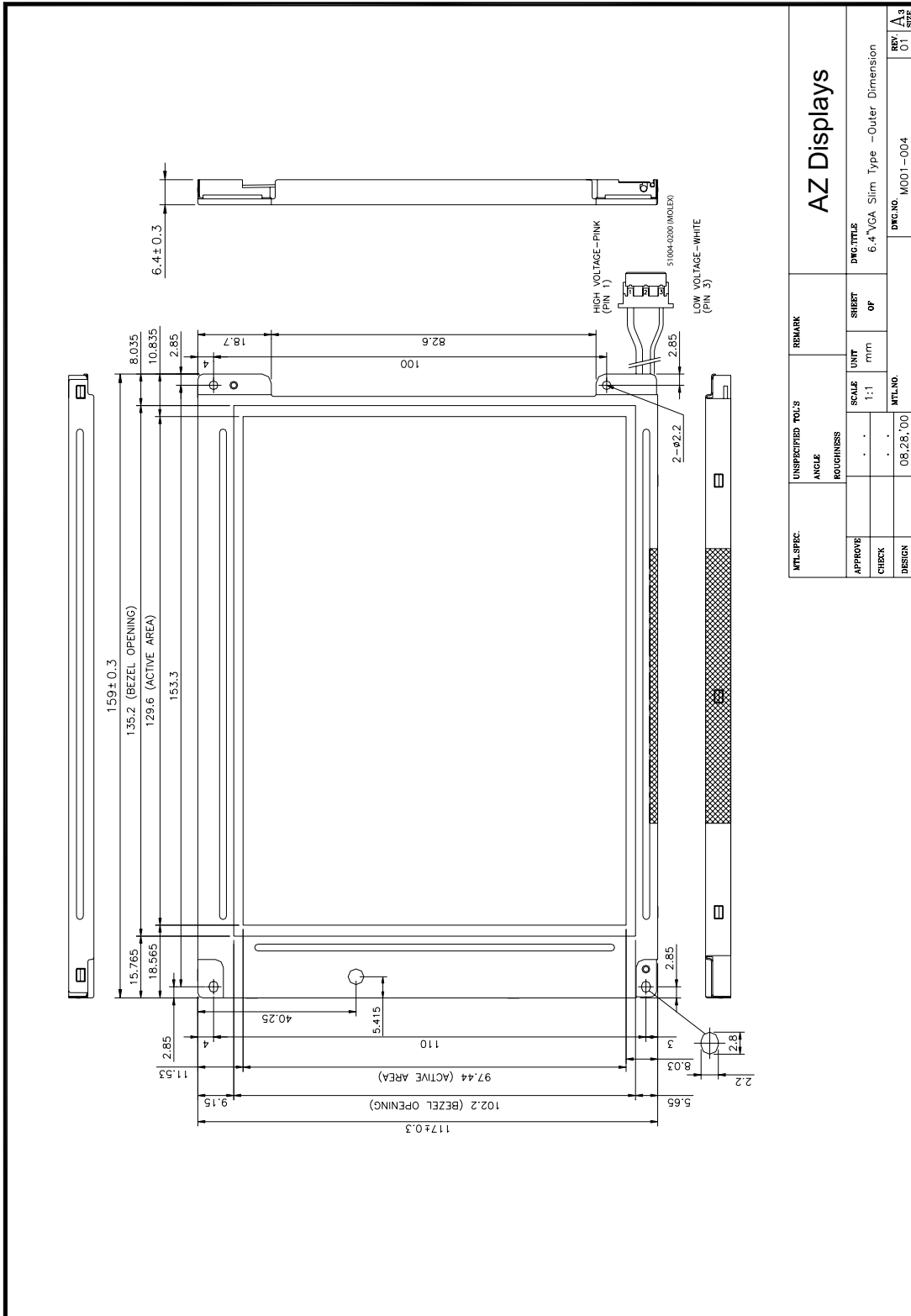

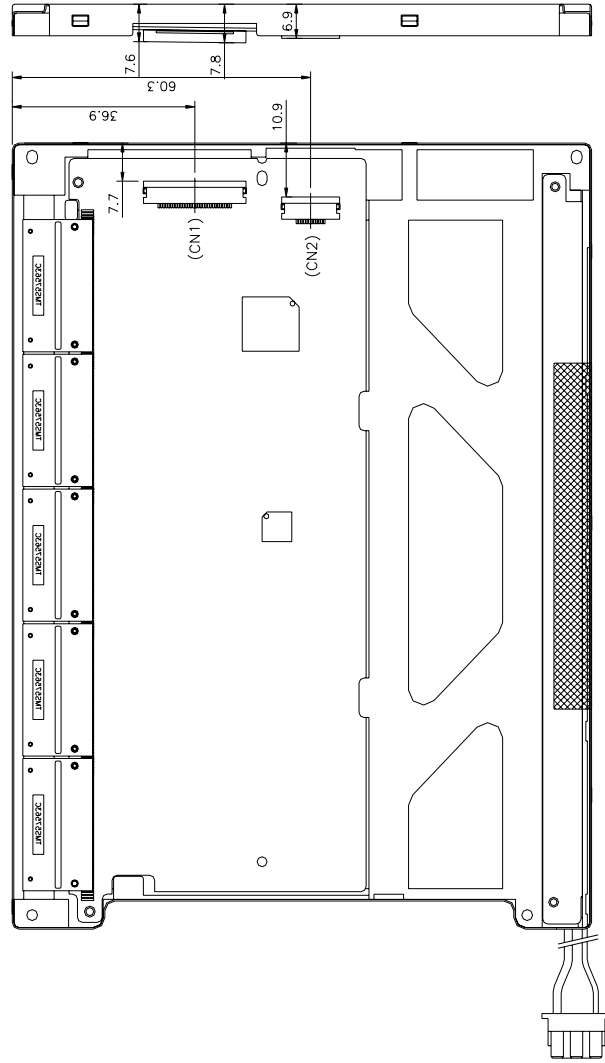

NOTE:

- 1).CN1:ELCO, 6210-30P
- 2).CN2:JST FLH-RSM1-12PIN

AZ Displays

MTL.SPEC.	UNSPECIFIED TOOLS	REMARK	AZ Displays		
	ANGLE				
	ROUGHNESS		DWG.TITLE	6.4"VGA Slim Type -Outer Dimension	
APPROVE	SCALE	UNIT	SHEET	OF	
CHECK	1:1	mm			
DESIGN	08.28.100	MTL.NO.	DWG.NO. M001-004		
	Formky		REV: A3		
			01		
			SIZE		

5. Input / Output Terminals

5-1) TFT-LCD Panel Driving

Connector (1) type : ELCO , 6210-30PIN

Pin No.	Symbol	Function	Remark
1	CLK	Clock Signal for Sampling Image Digital Data	
2	Hsync	Horizontal Synchronous Signal	
3	Vsync	Vertical Synchronous Signal	
4	GND	Ground (0V)	
5	R0	Red Image Data Signal (LSB)	
6	R1	Red Image Data Signal	
7	R2	Red Image Data Signal	
8	R3	Red Image Data Signal	
9	R4	Red Image Data Signal	
10	R5	Red Image Data Signal (MSB)	
11	GND	Ground (0V)	
12	G0	Green Image Data Signal (LSB)	
13	G1	Green Image Data Signal	
14	G2	Green Image Data Signal	
15	G3	Green Image Data Signal	
16	G4	Green Image Data Signal	
17	G5	Green Image Data Signal (MSB)	
18	GND	Ground (0V)	
19	B0	Blue Image Data Signal (LSB)	
20	B1	Blue Image Data Signal	
21	B2	Blue Image Data Signal	
22	B3	Blue Image Data Signal	
23	B4	Blue Image Data Signal	
24	B5	Blue Image Data Signal (MSB)	
25	GND	Ground (0V)	
26	NC	No connection	
27	VCC	DC +3.3V Power Supply	
28	VCC	DC +3.3V Power Supply	
29	NC	No connection	
30	NC	No connection	

5-2) Backlight driving

Pin No	Symbol	Description	Remark
1	VL1	Input terminal (Hi voltage side)	Wire color : Pink
2	VL2	Input terminal (Low voltage side)	Wire Color : White Note 5-1

Note 5-1 : Low voltage side of backlight connects with ground of LED circuits.

5-3) Input / Output Connector

- A) LCD module connector
ELCO , 6210-30PIN
Down Connector
Pin No. : 30
Pitch : 0.5 mm
- B) Backlight Connector
MOLEX 51004-0200
Pin No. : 2
Red : LED Anode
White : LED Cathode

6. Absolute Maximum Ratings :

GND=0V, Ta=25°C

Parameters	Symbol	MIN.	MAX.	Unit	Remark
+3.3V Supply Voltage	V _{CC}	-0.3	+4.0	V	
Input Signals Voltage	V _{sig}	-0.3	V _{CC} +0.3	V	Note 6-1
Storage Temperature	T _{stg}	-20	+70	°C	Note 6-2
Operating Temperature	T _{opa}	-0	+60	°C	

Note 6-1 : Input signals include CLK, Hsync, Vsync, R[0:5], G[0:5] and B[0:5].

Note 6-2 : Humidity : 95% RH Max. at Ta ≤ 40°C.

Maximum wet-bulb temperature is at 39 °C or less at Ta > 40 °C.

No condensation.

7. Electrical Characteristics

7-1) Recommended Operating Conditions :

A) Driving for TFT-LCD panel

GND = 0V , Ta = 25 °C

Parameters		Symbol	Min.	Typ.	Max.	Unit	Remark
+3.3V	Supply Voltage	V _{CC}	+3.15	+3.3	+3.6	V	
	Supply Input Ripple Voltage	V _{CCRP}			0.1	Vp-p	V _{CC} =+3.3V
Input Signals Voltage (High)		V _{IH}	+3.0	+3.3	+3.6	V	
Input Signals Voltage (Low)		V _{IL}	-	0	+0.3	V	

B) Driving for backlight

Ta = 25 °C

Item	Symbol	Min.	Typ.	Max.	Unit	Remark
LED Current	I _L	-	350	420	mA	Note 7-1
LED Voltage	V _L	-	11.5	12	V	
Lamp Life Time		-	30,000	-	Hr	

Note 7-1 : In order to satisfy the quality of B/L, the LED current should be less than Max. to avoid the abnormal display image caused by B/L heat.

7-2) Power Consumption

Parameters	Symbol	Typ.	Max.	Unit	Remark
+3.3V Current Dissipation	I_{CC}	170	200	mA	
Input Signals Current (High)	I_{IH}		100	μA	$V_{IH} = +3.3V$
Input Signals Current (Low)	I_{IL}		100	μA	$V_{IL} = 0V$
LCD Panel Power Consumption		0.56	0.66	W	Note 7-4
Backlight Power Consumption		4	5	W	Note 7-5

Note 7-4 : The power consumption of backlight is not included.

Note 7-5 : Backlight power consumption is calculated by $I_L \times V_L$.

7-3) Input / Output signal timing chart

Parameters	Symbol	Min.	Typ.	Max.	Unit	Note	
Frequency	$F_c = 1/T_c$		25.175		MHz	Note 7-6	
Clock	High Time	Tckh	10		ns		
	Low Time	Tckl	10		ns		
	Periodic = Line	Thp		31.778	μs	Note 7-6	
Hsync			800	1024	clock	Note 7-6	
	Pulse Width	Thpw	2	96	200	clock	
	Back Porch	Thbp	2	49	64	clock	
Vsync			515	525	1024	line	Note 7-6
	Pulse Width	Tvpw	1	2		line	
	Back Porch	Tvbp	1	33	64	line	
Data	Setup Time	Tds	10		ns		
	Hold Time	Tdh	10		ns		
	Periodic = Line	Tep		800	1024	clock	
	Pulse Width (H)	Tepw	2	640	800	clock	
Horizontal Display Periodic	Thd	640	640	640	clock		
Hsync-CLK Phase Difference	Thc	10		Tc-10	ns		
Vsync-Hsync Phase Difference	Tvh	1		Thp-1	clock		

Note 7-6 : T_c is the period of sampling clock. In case of low-frequency, the image-flicker may occur.

(1) Vertical Timing :

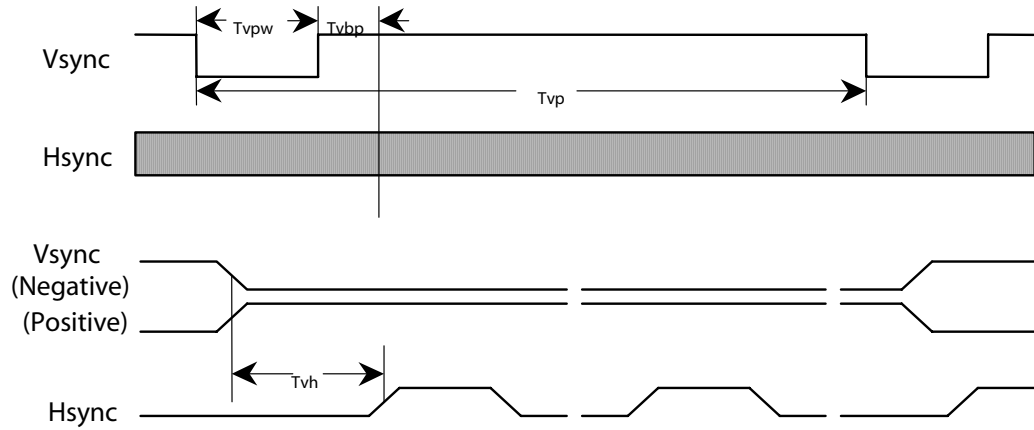

(2) Horizontal Timing :

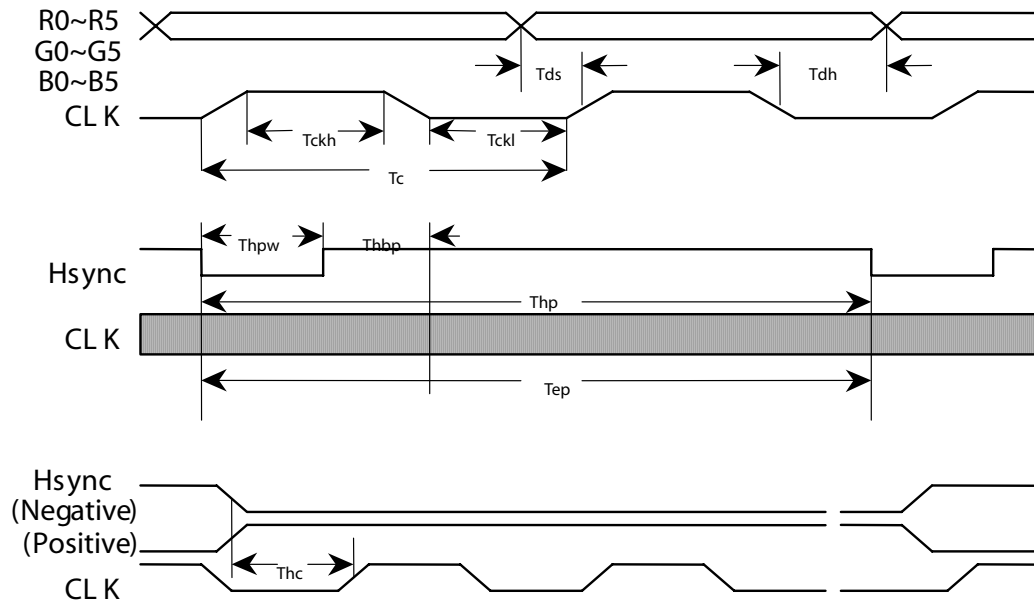

(3). Detail of Horizontal Timing :

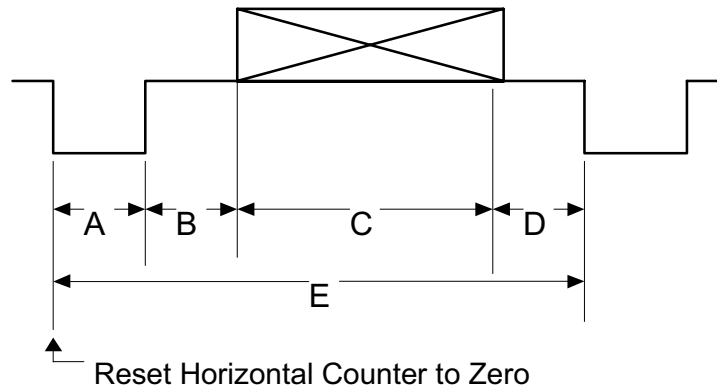

Item	Description	Clock Cycles	Time
A	Horizontal Width	96	3.813 μ s
B	Horizontal B-Porch	49	1.907 μ s
C	Horizontal Display	640	25.422 μ s
D	Horizontal F-Porch	16	0.636 μ s
E	Horizontal Total	800	31.778 μ s

(4). Detail of Vertical Timing :

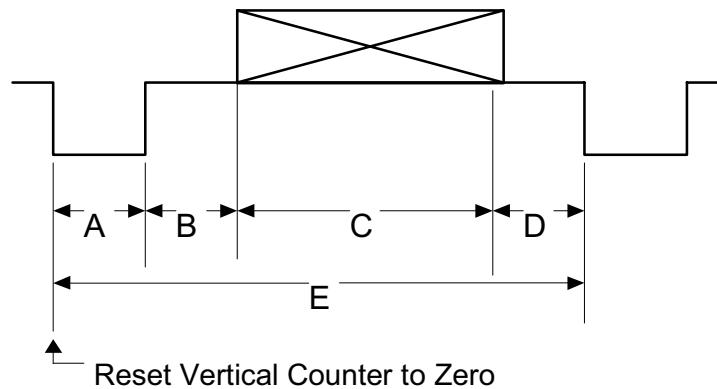

Item	Description	Horizontal Lines	Time
A	Vertical Width	2	63.5 μ s
B	Vertical B-Porch	33	1.049 ms
C	Vertical Display	480	15.253 ms
D	Vertical F-Porch	10	317.8 μ s
E	Vertical Total	525	16.683 ms

7-5) Pixel Arrangement

The LCD module pixel arrangement is the stripe.

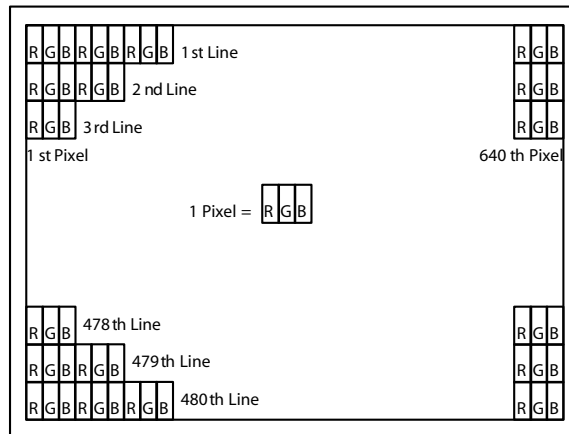

7-6) Display Color and Gray Scale Reference

Color		Input Color Data																	
		Red						Green						Blue					
		R5	R4	R3	R2	R1	R0	G5	G4	G3	G2	G1	G0	B5	B4	B3	B2	B1	B0
Basic Colors	Black	0	0	0	0	0	0	0	0	0	0	0	0	0	0	0	0	0	0
	Red (63)	1	1	1	1	1	1	0	0	0	0	0	0	0	0	0	0	0	0
	Green (63)	0	0	0	0	0	0	1	1	1	1	1	1	0	0	0	0	0	0
	Blue (63)	0	0	0	0	0	0	0	0	0	0	0	0	1	1	1	1	1	1
	Cyan	0	0	0	0	0	0	1	1	1	1	1	1	1	1	1	1	1	1
	Magenta	1	1	1	1	1	1	0	0	0	0	0	0	1	1	1	1	1	1
	Yellow	1	1	1	1	1	1	1	1	1	1	1	1	0	0	0	0	0	0
	White	1	1	1	1	1	1	1	1	1	1	1	1	1	1	1	1	1	1
Red	Red (00)	0	0	0	0	0	0	0	0	0	0	0	0	0	0	0	0	0	0
	Red (01)	0	0	0	0	0	1	0	0	0	0	0	0	0	0	0	0	0	0
	Red (02)	0	0	0	0	1	0	0	0	0	0	0	0	0	0	0	0	0	0
	Darker																		
	↓	↓	↓	↓	↓	↓	↓	↓	↓	↓	↓	↓	↓	↓	↓	↓	↓	↓	↓
	Brighter																		
	Red (61)	1	1	1	1	0	1	0	0	0	0	0	0	0	0	0	0	0	0
	Red (62)	1	1	1	1	1	0	0	0	0	0	0	0	0	0	0	0	0	0
Red (63)	1	1	1	1	1	1	0	0	0	0	0	0	0	0	0	0	0	0	
Green	Green (00)	0	0	0	0	0	0	0	0	0	0	0	0	0	0	0	0	0	0
	Green (01)	0	0	0	0	0	0	0	0	0	0	0	1	0	0	0	0	0	0
	Green (02)	0	0	0	0	0	0	0	0	0	0	1	0	0	0	0	0	0	0
	Darker																		
	↓	↓	↓	↓	↓	↓	↓	↓	↓	↓	↓	↓	↓	↓	↓	↓	↓	↓	↓
	Brighter																		
	Green (61)	0	0	0	0	0	0	1	1	1	1	0	1	0	0	0	0	0	0
	Green (62)	0	0	0	0	0	0	1	1	1	1	1	0	0	0	0	0	0	0
Green (63)	0	0	0	0	0	0	1	1	1	1	1	1	0	0	0	0	0	0	
Blue	Blue (00)	0	0	0	0	0	0	0	0	0	0	0	0	0	0	0	0	0	0
	Blue (01)	0	0	0	0	0	0	0	0	0	0	0	0	0	0	0	0	0	1
	Blue (02)	0	0	0	0	0	0	0	0	0	0	0	0	0	0	0	0	1	0
	Darker																		
	↓	↓	↓	↓	↓	↓	↓	↓	↓	↓	↓	↓	↓	↓	↓	↓	↓	↓	↓
	Brighter																		
	Blue (61)	0	0	0	0	0	0	0	0	0	0	0	0	1	1	1	1	0	1
	Blue (62)	0	0	0	0	0	0	0	0	0	0	0	0	1	1	1	1	1	0
Blue (63)	0	0	0	0	0	0	0	0	0	0	0	0	1	1	1	1	1	1	

8. Power On Sequence

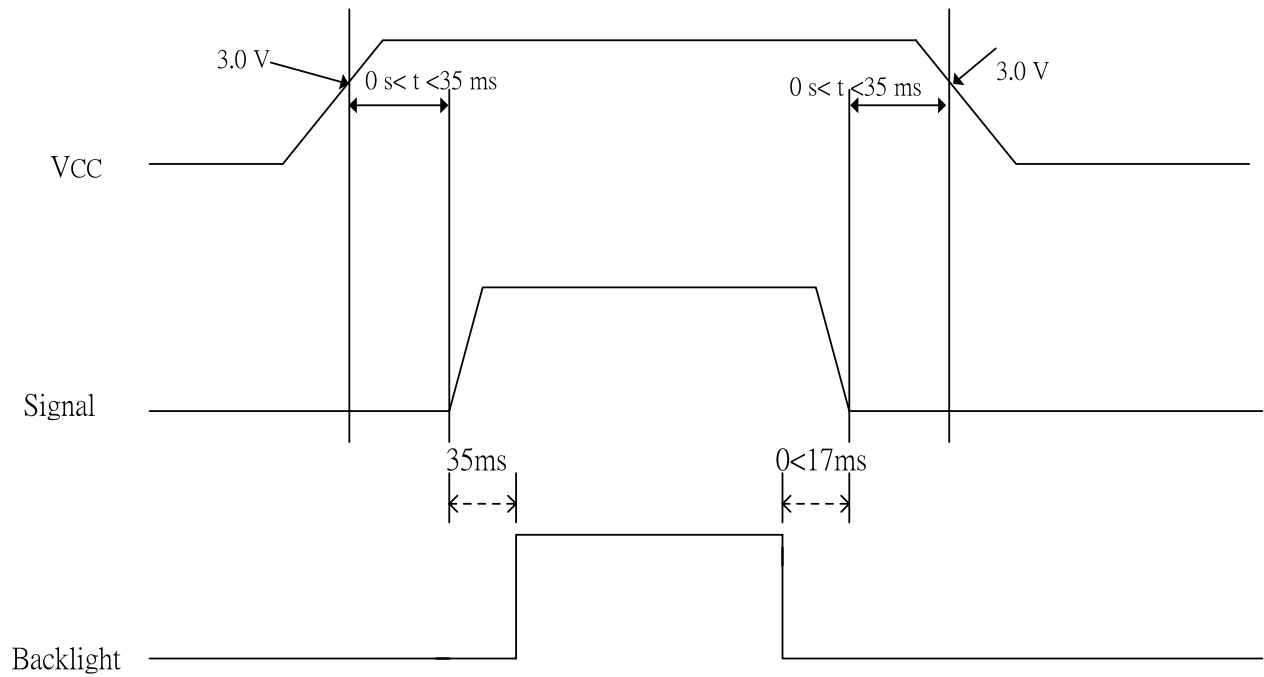

1. The supply voltage for input signals should be same as V_{CC} .
2. When the power is off , please keep whole signals (Hsync, Vsync, CLK, Data) low level or high impedance

9. Optical Characteristics

9-1) Specification :

Ta=25°C

Parameter	Symbol	Condition	MIN.	TYP.	MAX.	Unit	Remarks
Viewing Angle	Horizontal	θ	± 35	± 45		deg	Note 9-3
	Vertical	θ (to 12 o'clock)	10	15	-	deg	
		θ (to 6 o'clock)	30	35	-	deg	
Contrast Ratio		CR	200	400	-	-	Note 9-1
Response time	Rise	Tr	-	15	30	ms	Note 9-4
	Fall	Tf	-	25	50	ms	
Brightness		$\theta = 0^\circ / \varphi = 0$	-	700		cd/m ²	Note 9-2
Luminance Uniformity		U	55	80	-	%	Note 9-6
Lamp Life Time			-	30,000	-	hr	
White Chromaticity	x		0.230	0.280	0.330	-	
	y		0.270	0.320	0.370	-	
Cross Talk		$\theta = 0^\circ$	-	-	3	%	Note 9-5

All the optical measurement shall be executed 30 minutes after backlight being turn-on. The optical characteristics shall be measured in dark room (ambient illumination on panel surface less than 1 Lux). The measuring configuration shows as following figure.

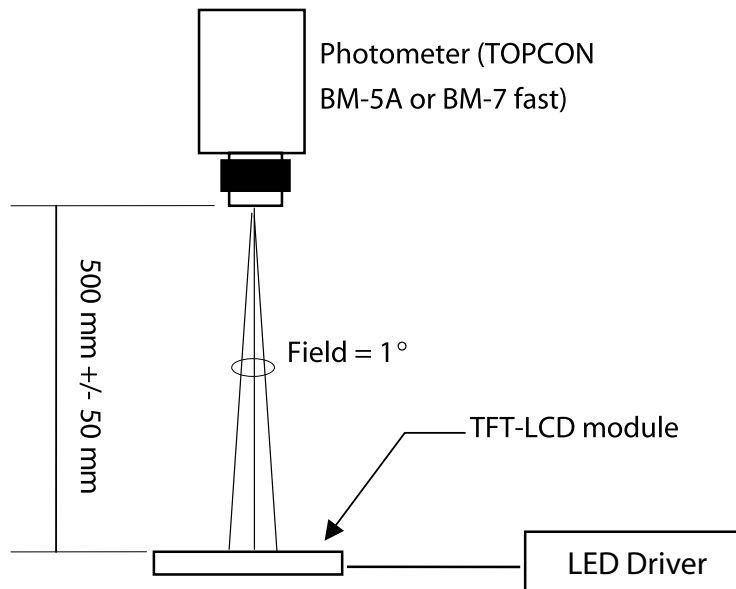

Optical characteristics measuring configuration

Note 9-1 : CR = $\frac{\text{Luminance when LCD is White}}{\text{Luminance when LCD is Black}}$

Contrast Ratio is measured in optimum common electrode voltage.

Note 9-2 : Topcon BM-7(fast) luminance meter 1° field of view is used in the testing immediately when the display is powered on (after warm-up, brightness can decrease by up to 5%).

Note 9-3 : The definitions of viewing angle diagrams :

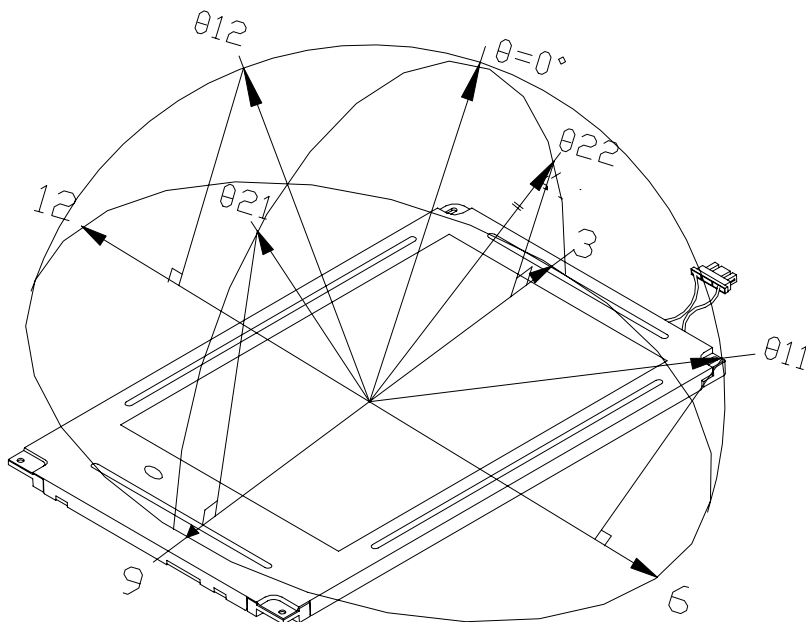

Note 9-4 : Definition of Response Time T_r and T_f :

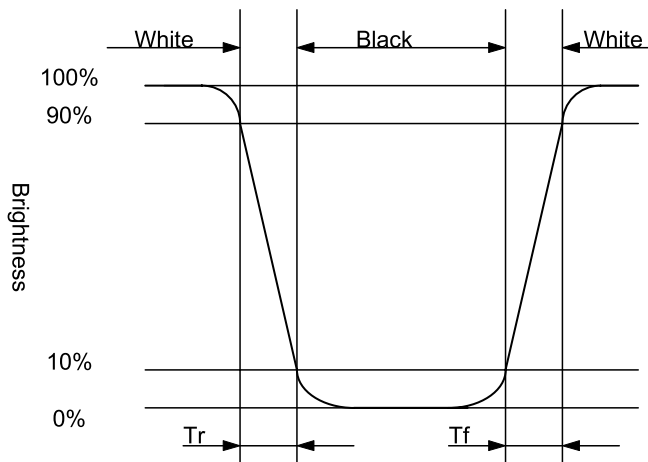

Note 9-5 : Cross Talk (CTK) = $\frac{|YA-YB|}{YA} \times 100\%$

YA : Brightness of Pattern A

YB : Brightness of Pattern B

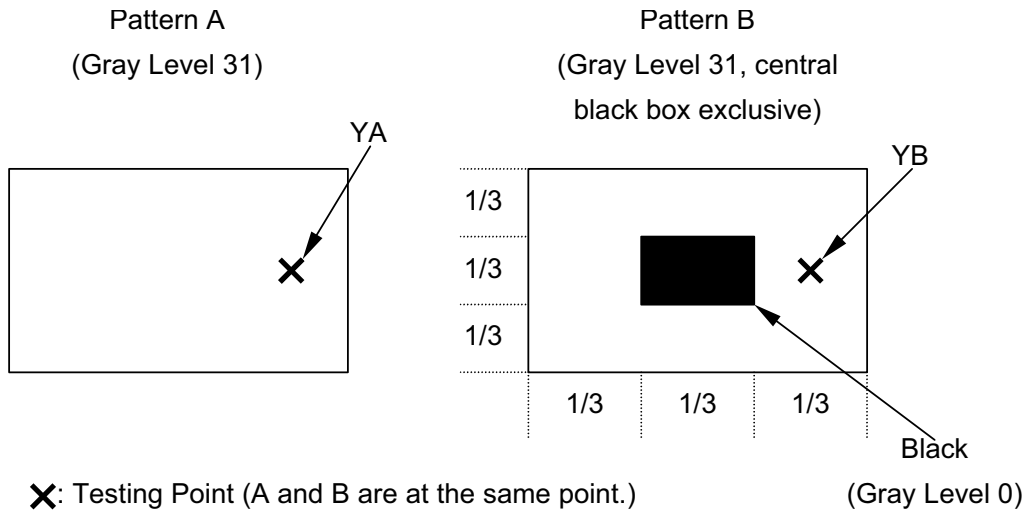

Note 9-6 : The uniformity of LCD is defined as

$$U = \frac{\text{The Minimum Brightness of the 9 testing Points}}{\text{The Maximum Brightness of the 9 testing Points}}$$

Luminance meter : BM-5A or BM-7 fast(TOPCON)

Measurement distance : 500 mm +/- 50 mm

Ambient illumination : < 1 Lux

Measuring direction : Perpendicular to the surface of module

The test pattern is white (Gray Level 63).

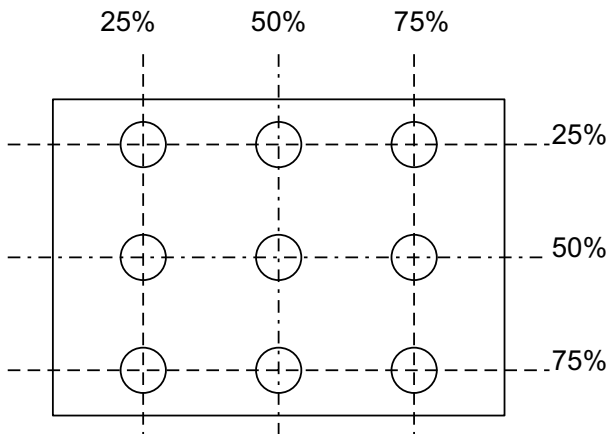

10. Handling Cautions

10-1) Mounting of module

- a) Please power off the module when you connect the input/output connector.
- b) Please connect the ground pattern of the inverter circuit surely. If the connection is not perfect, some following problems may happen possibly.
 - 1.The noise from the backlight unit will increase.
 - 2.The output from inverter circuit will be unstable.
 - 3.In some cases a part of module will heat.
- c) Polarizer which is made of soft material and susceptible to flaw must be handled carefully.
- d) Protective film (Laminator) is applied on surface to protect it against scratches and dirt. It is recommended to peel off the laminator before use and taking care of static electricity.

10-2) Precautions in mounting

- a) When metal part of the TFT-LCD module (shielding lid and rear case) is soiled, wipe it with soft dry cloth.
- b) Wipe off water drops or finger grease immediately. Long contact with water may cause discoloration or spots.
- c) TFT-LCD module uses glass which breaks or cracks easily if dropped or bumped on hard surface. Please handle with care.
- d) Since CMOS LSI is used in the module. So take care of static electricity and earth yourself when handling.

10-3) Adjusting module

- a) Adjusting volumes on the rear face of the module have been set optimally before shipment.
- b) Therefore, do not change any adjusted values. If adjusted values are changed, the specifications described may not be satisfied.

10-4) Others

- a) Do not expose the module to direct sunlight or intensive ultraviolet rays for many hours.
- b) Store the module at a room temperature place.
- c) The voltage of beginning electric discharge may over the normal voltage because of leakage current from approach conductor by to draw lump read lead line around.
- d) If LCD panel breaks, it is possibly that the liquid crystal escapes from the panel. Avoid putting it into eyes or mouth. When liquid crystal sticks on hands, clothes or feet. Wash it out immediately with soap.
- e) Observe all other precautionary requirements in handling general electronic components.
- f) Please adjust the voltage of common electrode as material of attachment by 1 module.
- g) The UL number for PCB is EE2956.

11. Reliability Test

No	Test Item	Test Condition
1	High Temperature Storage Test	Ta = +70 °C, 240 hrs
2	Low Temperature Storage Test	Ta = -20 °C, 240 hrs
3	High Temperature Operation Test	Ta = +60 °C, 240 hrs
4	Low Temperature Operation Test	Ta = 0 °C, 240 hrs
5	High Temperature & High Humidity Operation Test	Ta = +40 °C, 95%RH, 240 hrs
6	Thermal Cycling Test (non-operating))	-20°C → +70°C , 200 Cycles 30 min 30min
7	Vibration Test (non-operating)	Frequency : 10 ~ 57 Hz /Vibration Width :0.075mm 58-500 Hz/ Gravity :9.8m/s ² Sweep time: 11 minutes Test period: 3 hrs for each direction of X, Y, Z
8	Shock Test (non-operating)	Gravity :490m/s ² Direction: ±X, ±Y, ±Z Pulse Width :11ms, half sine wave
9	Electrostatic Discharge Test (non-operating)	150pF , 330Ω Air : ±15KV ; Contact : ±8KV 10 times/point , 9 point/panel face

Ta: ambient temperature

Note 11-1 : The protective film must be removed before temperature test.

[Judgement Criteria]

Under the display quality test conditions with normal operation state , there should be no change which may affect practical display function.

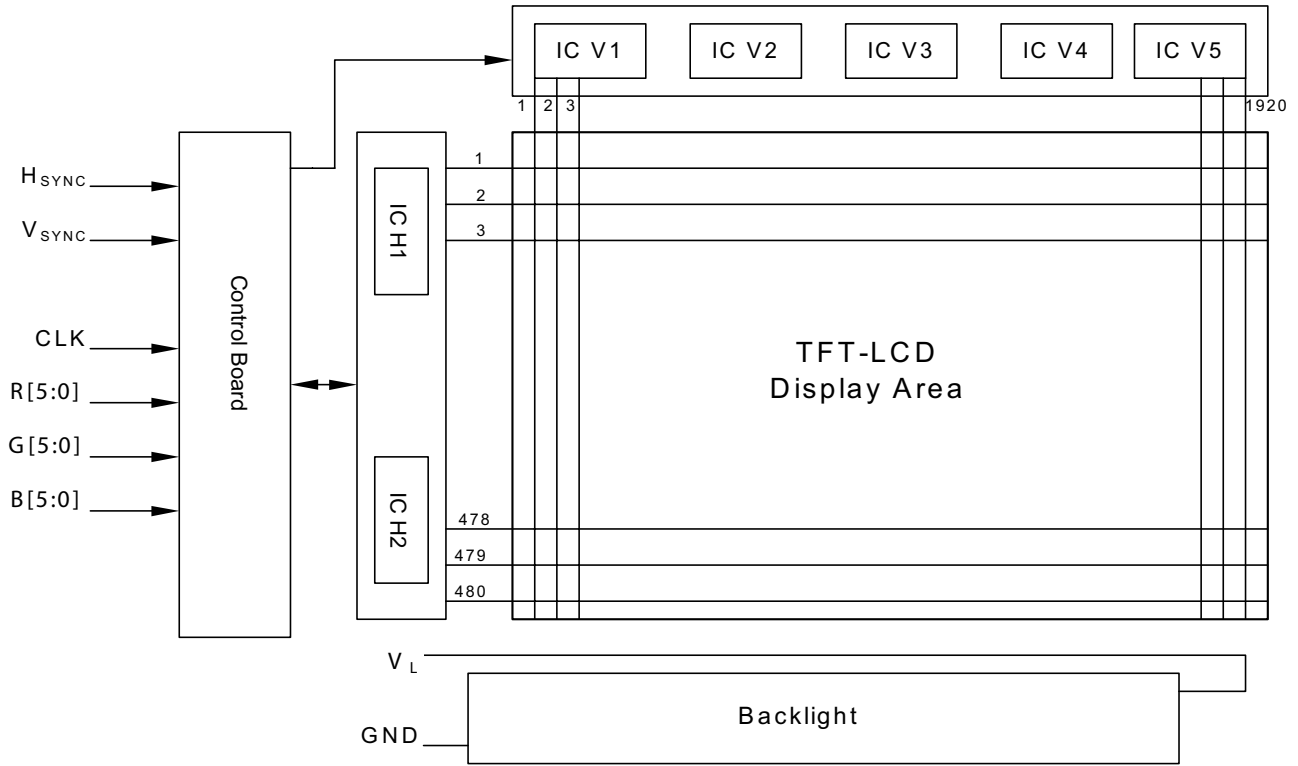

ZONE	REV.	DOCUMENT NO.	DESCRIPTION	DATE	REV. BY																														
<p>NOTE: 1.Q'TY: 30 pcs panel/carton. 2.Dimension: 680*440*250mm 3.Weight: TBD</p>																																			
		<table border="1" style="width:100%; border-collapse: collapse;"> <thead> <tr> <th>ITEM</th> <th>PART NO.</th> <th>DESCRIPTION</th> <th>QTY</th> <th>REMARK</th> </tr> </thead> <tbody> <tr> <td>5</td> <td>50-0100131</td> <td>CARTON</td> <td>1</td> <td></td> </tr> <tr> <td>4</td> <td>50-0300201</td> <td>PP緩衝材 底座</td> <td>1</td> <td></td> </tr> <tr> <td>3</td> <td>50-0500051</td> <td>Pink Bag 150*250mm</td> <td>30</td> <td>抗靜電</td> </tr> <tr> <td>2</td> <td>PD064VT2T1</td> <td></td> <td>30</td> <td></td> </tr> <tr> <td>1</td> <td>50-0300191</td> <td>PP緩衝材 上蓋</td> <td>1</td> <td></td> </tr> </tbody> </table>		ITEM	PART NO.	DESCRIPTION	QTY	REMARK	5	50-0100131	CARTON	1		4	50-0300201	PP緩衝材 底座	1		3	50-0500051	Pink Bag 150*250mm	30	抗靜電	2	PD064VT2T1		30		1	50-0300191	PP緩衝材 上蓋	1			
ITEM	PART NO.	DESCRIPTION	QTY	REMARK																															
5	50-0100131	CARTON	1																																
4	50-0300201	PP緩衝材 底座	1																																
3	50-0500051	Pink Bag 150*250mm	30	抗靜電																															
2	PD064VT2T1		30																																
1	50-0300191	PP緩衝材 上蓋	1																																
MTL.SPEC.		UNSPECIFIED TOL'S		REMARK																															
		ANGLE																																	
		ROUGHNESS																																	
APPROVE		SCALE	UNIT	SHEET	DWG.TITLE																														
CHECK				1 OF 1	Packing Draw																														
DRAWN	陳萬典	00.08.30	MTL.NO.	DWG FILE:	REV. 01																														