

SMD ■ B

12-23C/R6GHBHC-M34/2C(XY)

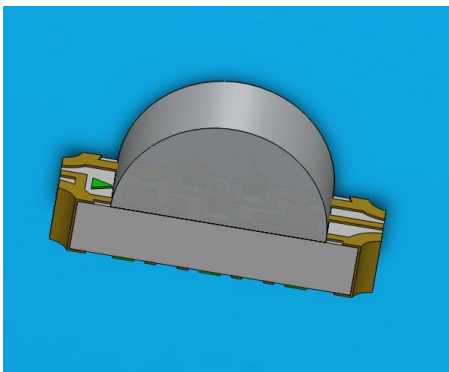

Features

- Package in 8mm tape on 7" diameter reel.
- Compatible with automatic placement equipment.
- Compatible with infrared and vapor phase reflow solder process.
- Multi-color type.
- Pb-free.
- The product itself will remain within RoHS compliant version.
- Compliance with EU REACH.
- Compliance Halogen Free .(Br <900 ppm ,Cl <900 ppm , Br+Cl < 1500 ppm)

Description

- The 12-23C SMD LED is much smaller than lead frame type components, thus enable smaller board size, higher packing density, reduced storage space and finally smaller equipment to be obtained.
- Besides, lightweight makes them ideal for miniature applications. etc.

Applications

- Backlighting in dashboard and switch.
- Telecommunication: indicator and backlighting in telephone and fax.
- Flat backlight for LCD, switch and symbol.
- General use.

Device Selection Guide

Code	Chip Materials	Emitted Color	Resin Color
R6	AlGaInP	Brilliant Red	
GH	InGaN	Brilliant Green	Water Clear
BH	InGaN	Blue	

Absolute Maximum Ratings (Ta=25°C)

Parameter	Symbol	Code	Rating	Unit
Reverse Voltage	V_R		5	V
Forward Current	I_F	R6	25	mA
		GH	25	
		BH	10	
Peak Forward Current (Duty 1/10 @1KHz)	I_{FP}	R6	60	mA
		GH	100	
		BH	100	
Power Dissipation	P_d	R6	60	mW
		GH	95	
		BH	40	
Electrostatic Discharge(HBM)	ESD	R6	2000	V
		GH	150	
		BH	150	
Operating Temperature	T_{opr}		-40 ~ +85	°C
Storage Temperature	T_{stg}		-40 ~ +90	°C
Soldering Temperature	T_{sol}		Reflow Soldering : 260 °C for 10 sec. Hand Soldering : 350 °C for 3 sec.	

Electro-Optical Characteristics (Ta=25°C)

Parameter	Symbol	Code	Min.	Typ.	Max.	Unit	Condition
Luminous Intensity	I_v		180	-----	450	mcd	
Viewing Angle	$2\theta_{1/2}$		-----	100	-----	Deg	
Peak Wavelength	λ_p	R6	-----	632	-----	nm	
		GH	-----	518	-----		
		BH	-----	468	-----		
Dominant Wavelength	λ_d	R6	-----	624	-----	nm	R6: $I_F=10mA$ GH: $I_F=14mA$ BH: $I_F=8mA$
		GH	-----	525	-----		
		BH	-----	470	-----		
Spectrum Radiation Bandwidth	$\Delta\lambda$	R6	-----	20	-----	nm	
		GH	-----	35	-----		
		BH	-----	25	-----		
Forward Voltage	V_F	R6	1.70	-----	2.30	V	
		GH	2.90	-----	3.40		
		BH	2.80	-----	3.20		
Reverse Current	I_R	R6	-----	-----	10	μA	$V_R=5V$
		GH	-----	-----	50		
		BH	-----	-----	50		

Note:

1. Tolerance of Luminous Intensity: $\pm 11\%$
2. Tolerance of Forward Voltage: $\pm 0.1V$

Bin Range of Luminous Intensity

Bin Code	Min.	Max.	Unit	Condition
S	180	285	mcd	R6: I _F =10mA GH: I _F =14mA BH: I _F =8mA
T	285	450		

Bin Range Of Forward Voltage R6

Bin Code	Min.	Max.	Unit	Condition
1	1.70	1.90	V	R6: I _F =10mA GH: I _F =14mA BH: I _F =8mA
2	1.90	2.10		
3	2.10	2.30		

Bin Range Of Forward Voltage GH

Bin Code	Min.	Max.	Unit	Condition
1	2.90	3.15	V	R6: I _F =10mA GH: I _F =14mA BH: I _F =8mA
2	3.15	3.40		

Bin Range Of Forward Voltage BH

Bin Code	Min.	Max.	Unit	Condition
1	2.80	3.00	V	R6: I _F =10mA GH: I _F =14mA BH: I _F =8mA
2	3.00	3.20		

Note:

1. Tolerance of Luminous Intensity: ±11%
2. Tolerance of Forward Voltage: ±0.1V

Chromaticity Coordinates Specifications for Bin Grading

Bin Code	CIE_x	CIE_y	Condition
103	0.1570	0.1050	R6: I _F =10mA GH: I _F =14mA BH: I _F =8mA
	0.1570	0.1300	
	0.1820	0.1400	
	0.1820	0.1150	
104	0.1820	0.1150	
	0.1820	0.1400	
	0.2070	0.1500	
	0.2070	0.1250	
105	0.2070	0.1250	
	0.2070	0.1500	
	0.2320	0.1600	
	0.2320	0.1350	
128	0.1570	0.1300	
	0.1570	0.1550	
	0.1820	0.1650	
	0.1820	0.1400	
129	0.1820	0.1400	
	0.1820	0.1650	
	0.2070	0.1750	
	0.2070	0.1500	
130	0.2070	0.1500	
	0.2070	0.1750	
	0.2320	0.1850	
	0.2320	0.1600	
131	0.2320	0.1600	
	0.2320	0.1850	
	0.2570	0.1950	
	0.2570	0.1700	
152	0.1570	0.1550	
	0.1570	0.1800	
	0.1820	0.1900	
	0.1820	0.1650	
153	0.1820	0.1650	
	0.1820	0.1900	
	0.2070	0.2000	
	0.2070	0.1750	

Bin Code	CIE_x	CIE_y	Condition
154	0.2070	0.1750	R6:I _F =10mA GH:I _F =14mA BH:I _F =8mA
	0.2070	0.2000	
	0.2320	0.2100	
	0.2320	0.1850	
155	0.2320	0.1850	
	0.2320	0.2100	
	0.2570	0.2200	
	0.2570	0.1950	
177	0.1820	0.1900	
	0.1820	0.2150	
	0.2070	0.2250	
	0.2070	0.2000	
178	0.2070	0.2000	
	0.2070	0.2250	
	0.2320	0.2350	
	0.2320	0.2100	
179	0.2320	0.2100	
	0.2320	0.2350	
	0.2570	0.2450	
	0.2570	0.2200	

Notes:

- 1.The C.I.E. 1931 chromaticity diagram (Tolerance ± 0.01).
- 2.The products are sensitive to static electricity and care must be fully taken when handling products.

CIE Chromaticity Diagram

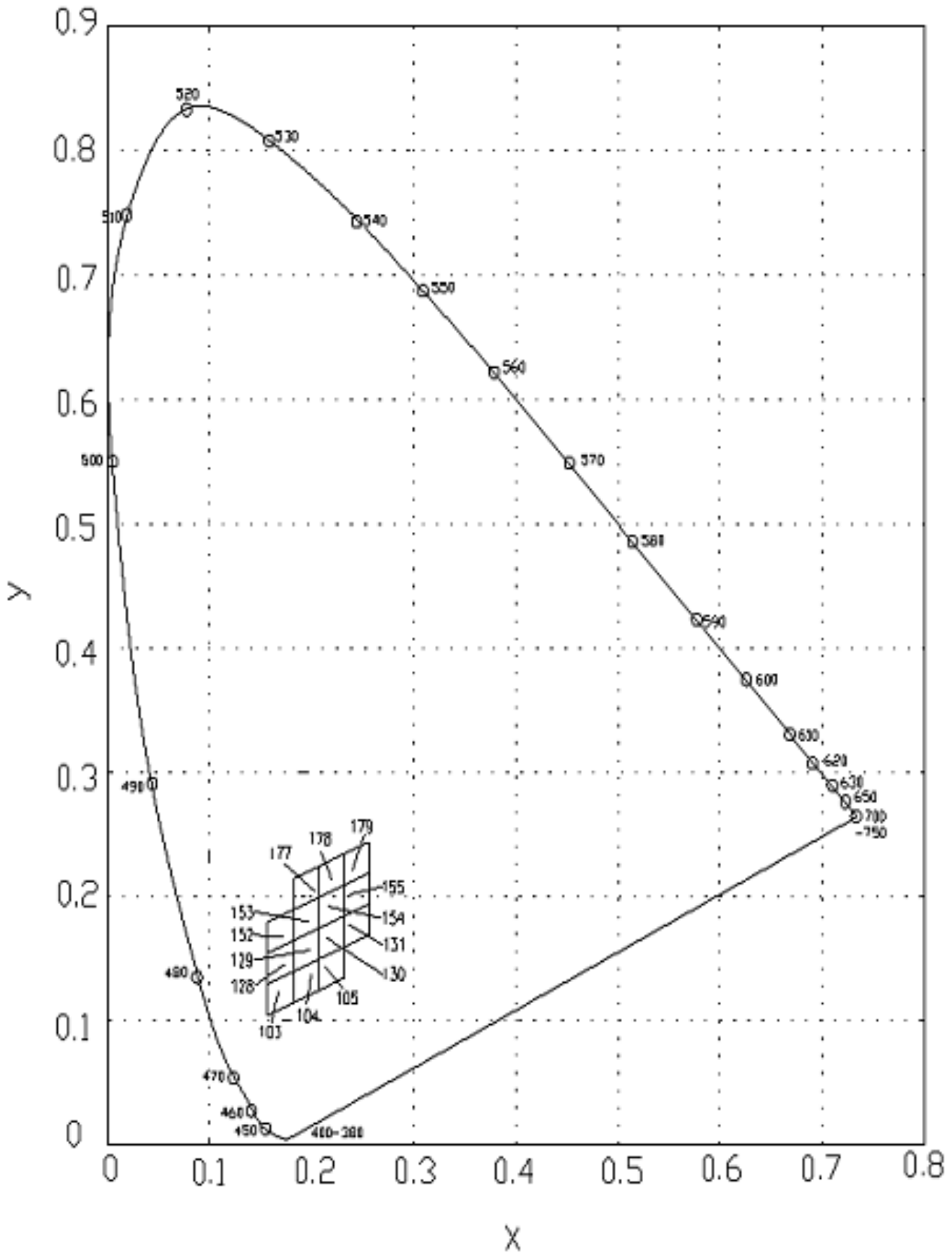

Typical Electro-Optical Characteristics Curves
R6

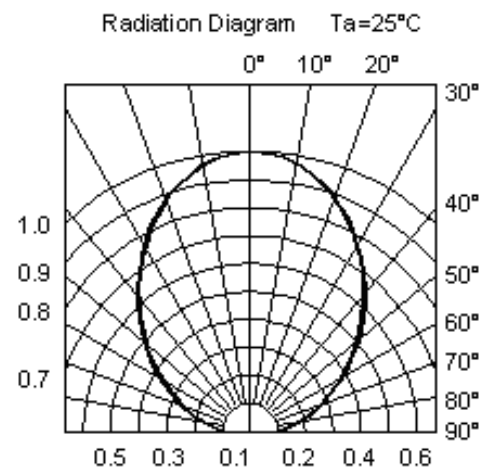
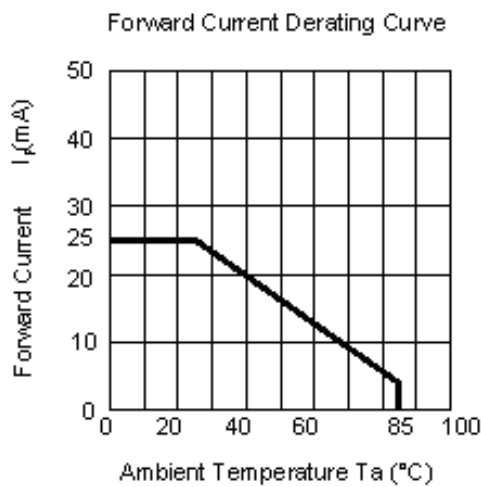
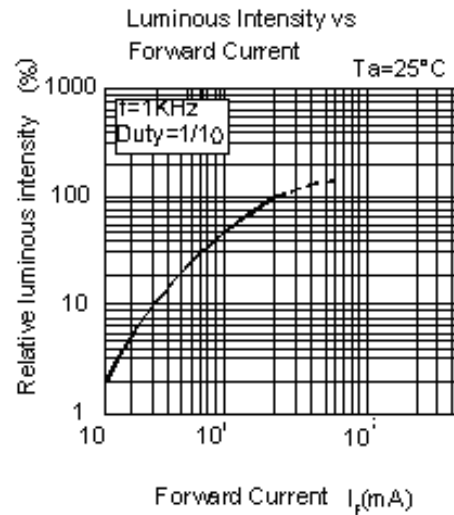
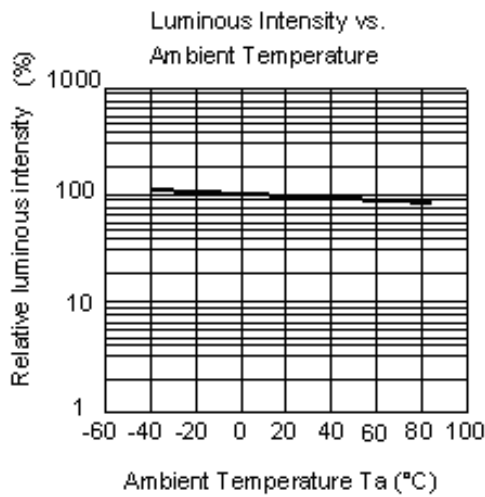
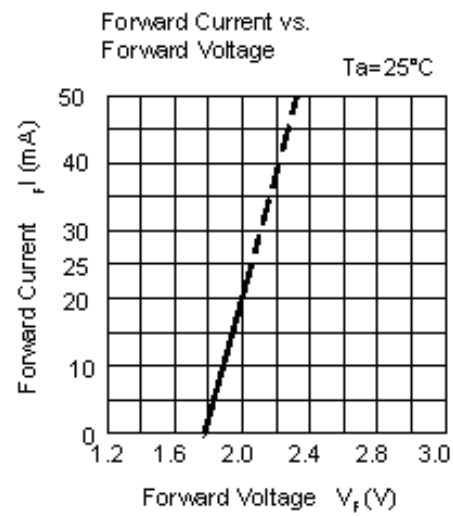
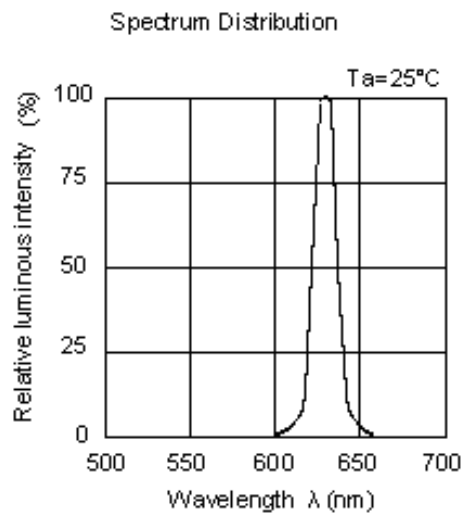

Typical Electro-Optical Characteristics Curves
 GH

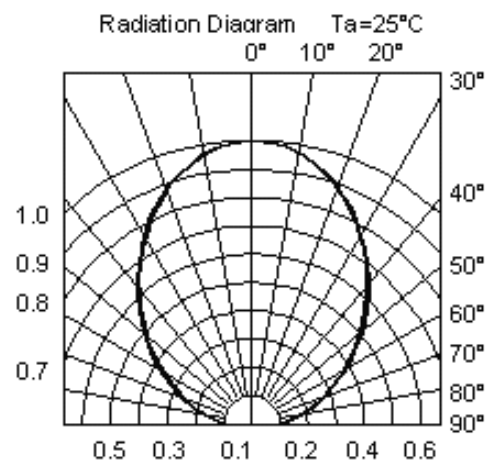
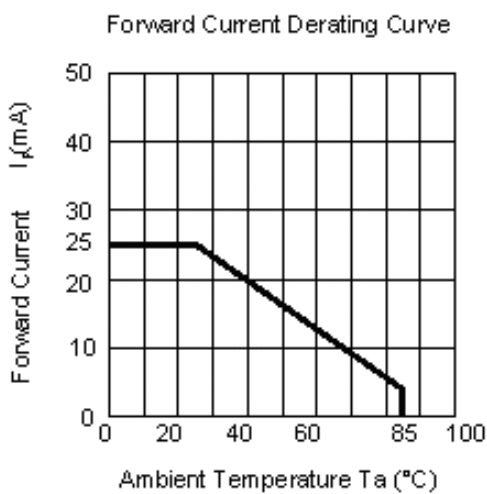
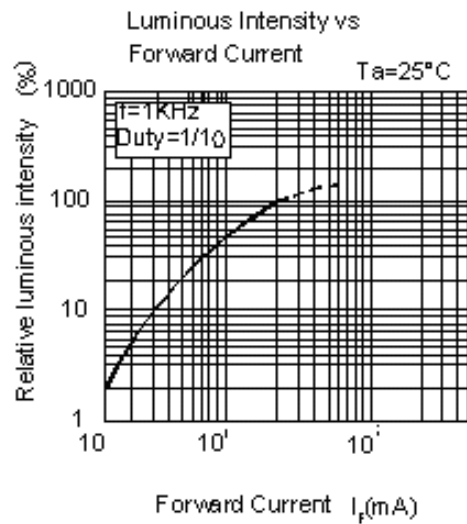
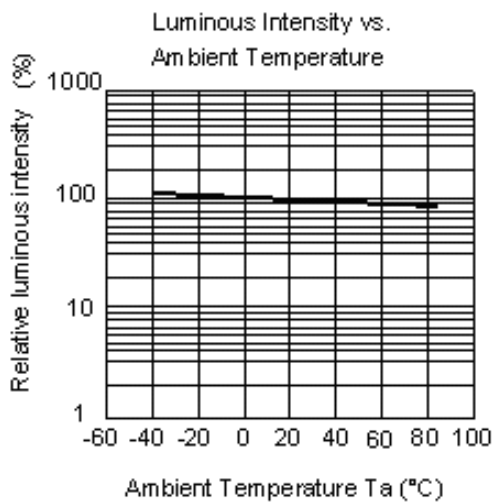
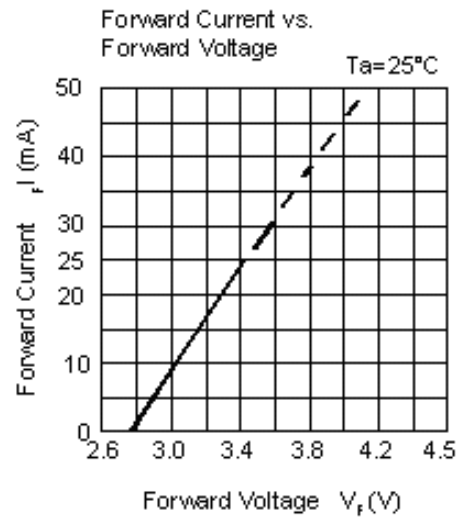
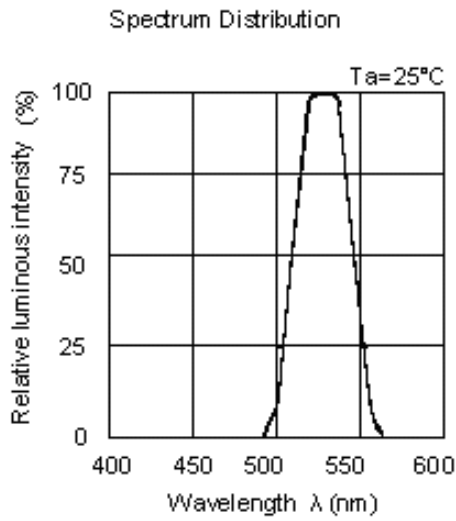

Typical Electro-Optical Characteristics Curves
 BH

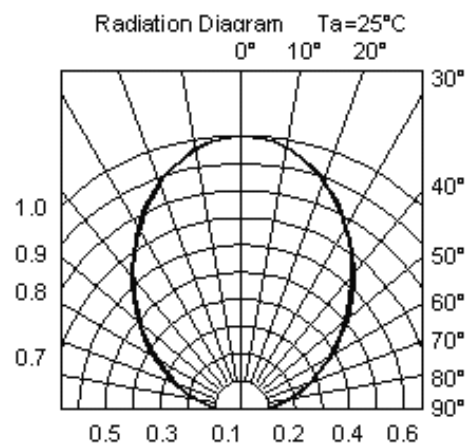
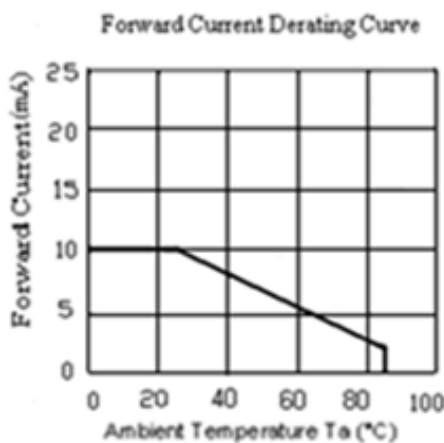
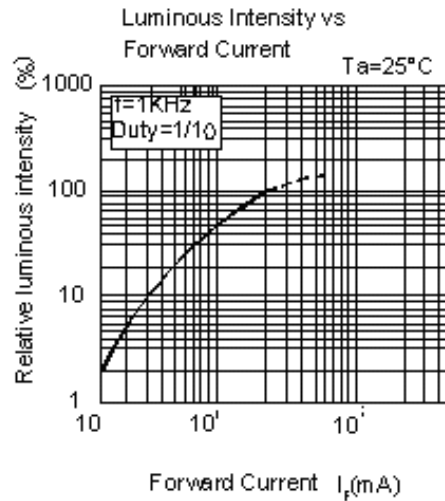
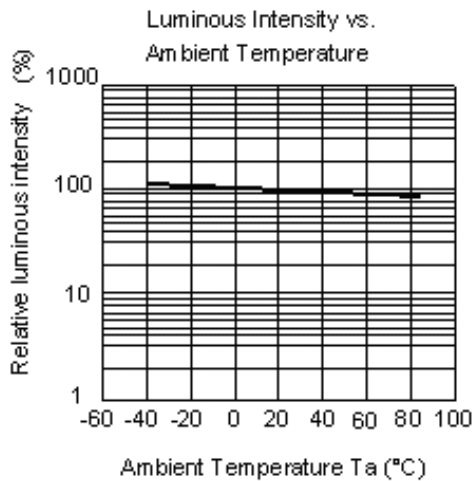
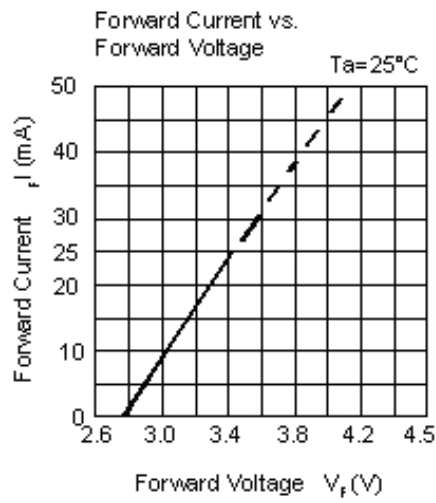
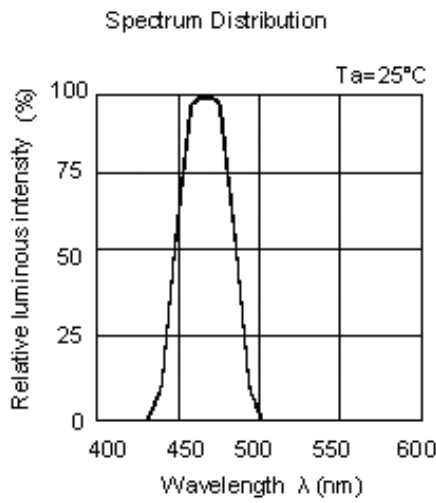

Package Dimension

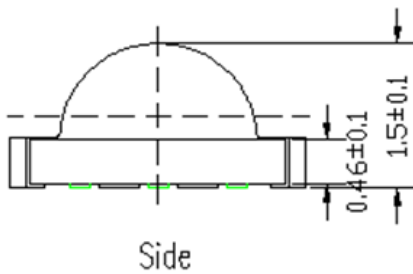
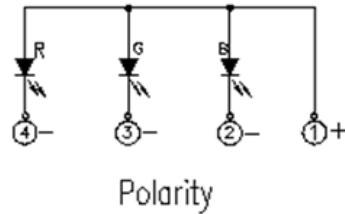
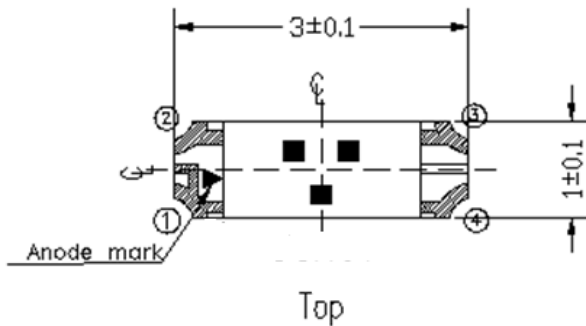

Recommend Soldering Pad

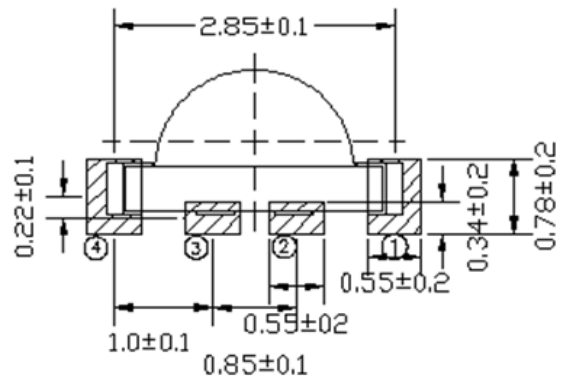
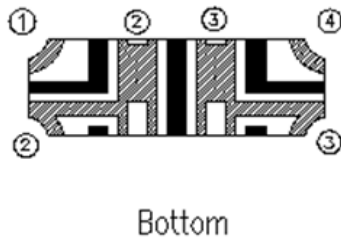

Suggested pad dimension is just for reference only.
 Please modify the pad dimension based on individual need.

Note: Tolerances unless mentioned ± 0.1 mm. Unit = mm

Moisture Resistant Packing Materials
 Label Explanation

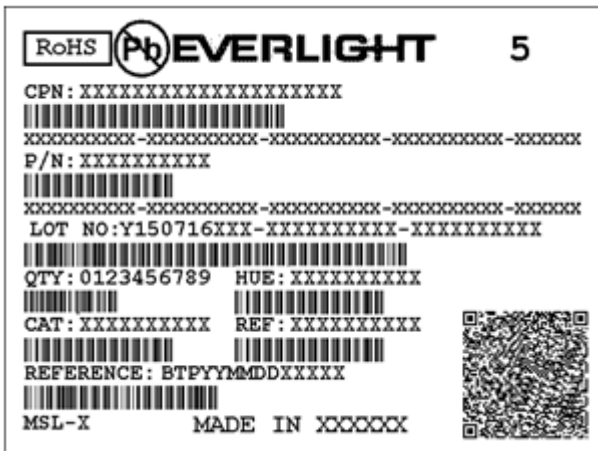

- CPN: Customer's Product Number
- P/N: Product Number
- QTY: Packing Quantity
- CAT: Luminous Intensity Rank
- HUE: Chromaticity Coordinates & Dom. Wavelength Rank
- REF: Forward Voltage Rank
- LOT No: Lot Number

Reel Dimensions

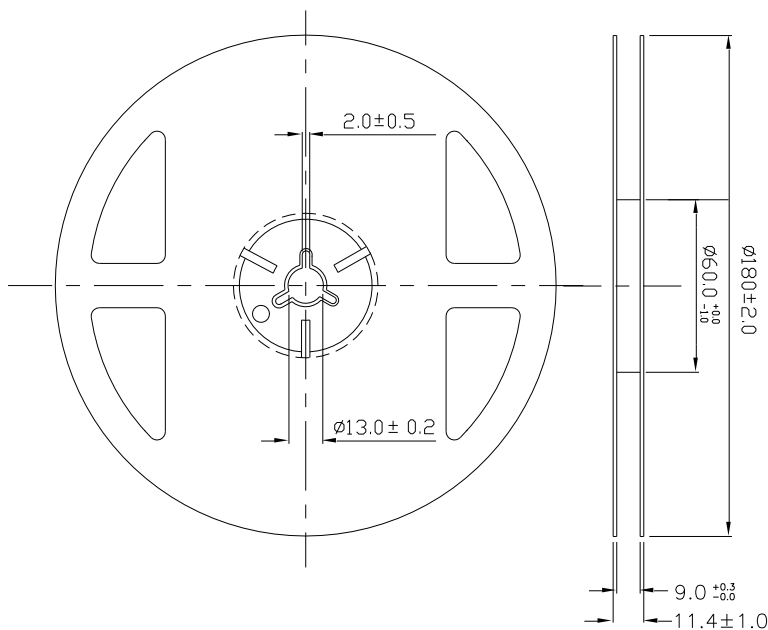

Note: The tolerances unless mentioned is $\pm 0.1\text{mm}$,Unit = mm

Carrier Tape Dimensions: Loaded quantity 2000 PCS per reel

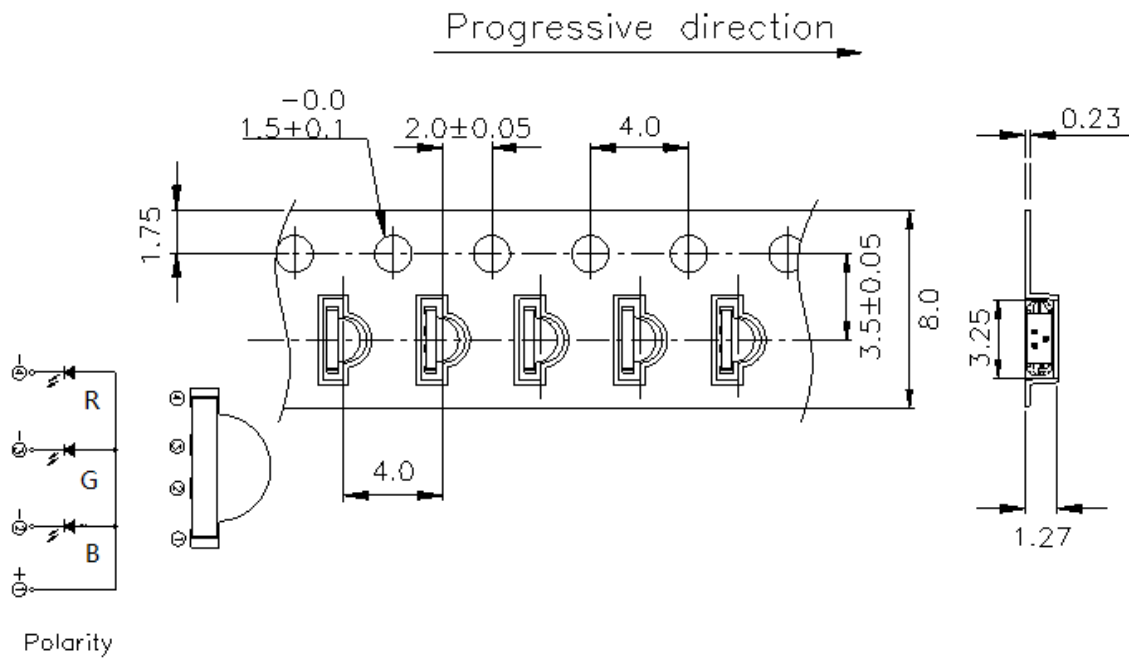

Note: The tolerances unless mentioned is $\pm 0.1\text{mm}$, Unit = mm

Moisture Resistant Packaging

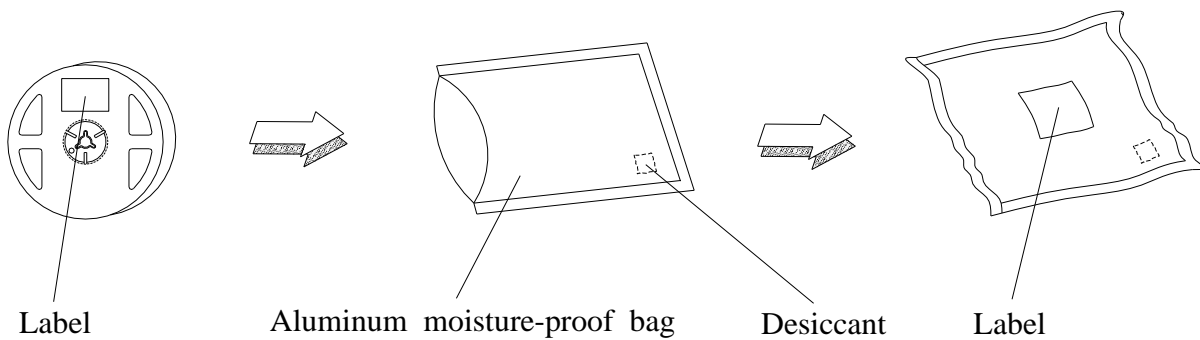

Precautions For Use

1. Over-current-proof

Customer must apply resistors for protection, otherwise slight voltage shift will cause big current change (Burn out will happen).

2. Storage

2.1 Do not open moisture proof bag before the products are ready to use.

2.2 Before opening the package: The LEDs should be kept at 30°C or less and 90%RH or less.

2.3 After opening the package: The LED's floor life is 1 year under 30°C or less and 60% RH or less. If unused LEDs remain, it should be stored in moisture proof packages.

2.4 If the moisture absorbent material (silica gel) has faded away or the LEDs have exceeded the storage time, baking treatment should be performed using the following conditions.

Baking treatment : 60±5°C for 24 hours.

3. Soldering Condition

3.1 Pb-free solder temperature profile

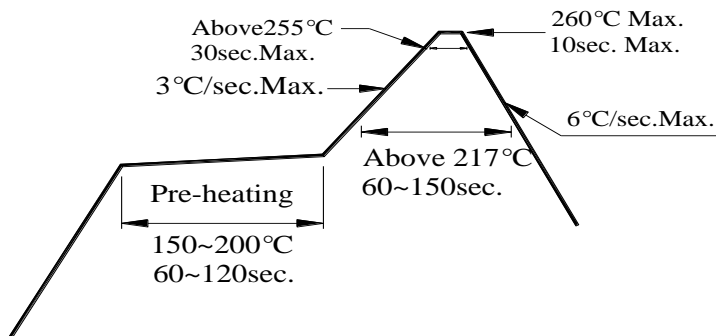

3.2 Reflow soldering should not be done more than two times.

3.3 When soldering, do not put stress on the LEDs during heating.

3.4 After soldering, do not warp the circuit board.

4. Soldering Iron

Each terminal is to go to the tip of soldering iron temperature less than 350°C for 3 seconds within once in less than the soldering iron capacity 25W. Leave two seconds and more intervals, and do soldering of each terminal. Be careful because the damage of the product is often started at the time of the hand solder.

5. Repairing

Repair should not be done after the LEDs have been soldered. When repairing is unavoidable, a double-head soldering iron should be used (as below figure). It should be confirmed beforehand whether the characteristics of the LEDs will or will not be damaged by repairing.

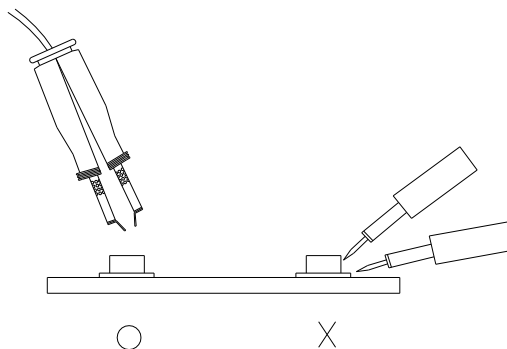

Application Restrictions

High reliability applications such as military/aerospace, automotive safety/security systems, and medical equipment may require different product. If you have any concerns, please contact Everlight before using this product in your application. This specification guarantees the quality and performance of the product as an individual component. Do not use this product beyond the specification described in this document.