



1.5A LOAD SWITCH WITH CONTROLLED TURN-ON

FEATURES

- Integrated 1.5A Single Channel Load Switch
- Input Voltage Range: 0.8V to 5.5V
- Low Threshold Control Input
- Quick Output Discharge Transistor
- Over-Temperature Protection
- Over Current Protection
- Short Circuit Protection
- Open-Drain Fault Flag Output
- Low ON-Resistance $R_{ON} = 40m\Omega$
- Halogen Free Product

APPLICATIONS

- Telecom Systems
- Set-Top-Box
- Consumer Electronics
- Notebooks / Netbooks

DESCRIPTION

The APE8988 is a low R_{ON} load switch with controlled turn on. It contains one N-channel MOSFET that can operate over an input voltage range of 0.8V to 5.5V and support maximum continuous current up to 1.5A. The switch is controlled by an on/off input (EN), which is capable of interfacing directly with low-voltage control signals.

Additional features include a 330Ω on-chip load resistor is added for output quick discharge when switch is turned off. A well protection is equipped when the device enters hard short circuit and thermal shutdown.

The APE8988 is available in small SOT-26 package with smallest components.

TYPICAL APPLICATION

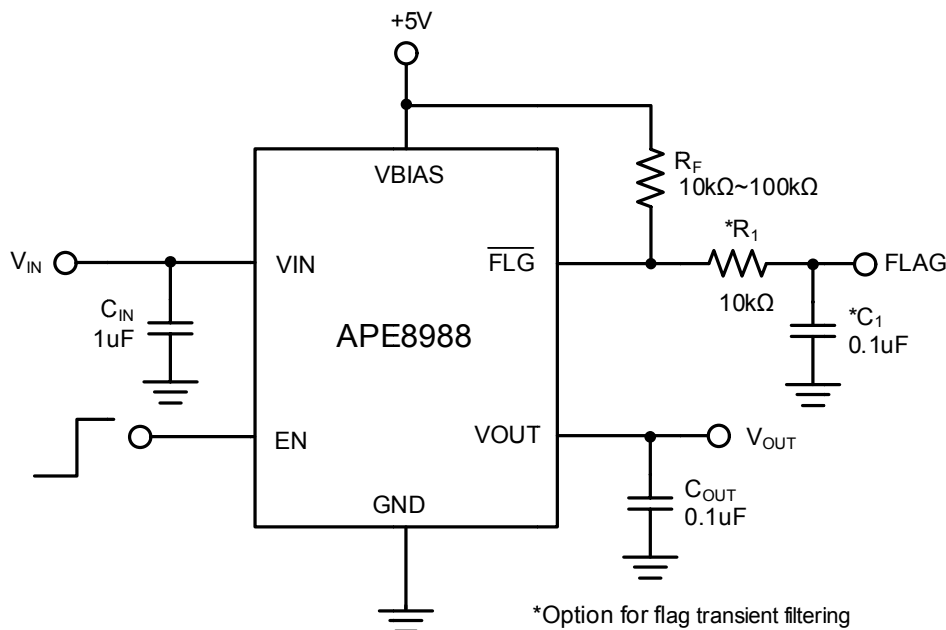



ORDERING / PACKAGE INFORMATION

APE8988X
└─ Package Type
 Y: SOT-26

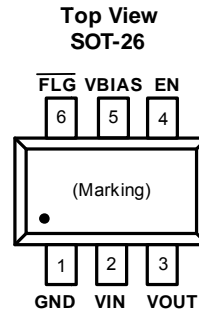

ABSOLUTE MAXIMUM RATINGS (at $T_A=25^\circ\text{C}$)

VIN	-0.3V to 6V
VBIAS	-0.3 to 6V
VOUT	VIN+0.3V
EN, /FLG	-0.3V to 6V
Storage Temperature Range (T_{ST})	-65 to +150°C
Junction Temperature (T_J)	150°C
Lead Temperature (Soldering, 10sec.)	260°C
Thermal Resistance from Junction to Ambient ($R\theta_{JA}$)	
SOT-26	250°C/W

RECOMMENDED OPERATING CONDITIONS

VIN	0.8V to 5.5V
VBIAS	4.5V to 5.5V ($V_{BIAS} \geq V_{IN}$)
VOUT	V_{IN}
CIN	$\geq 0.1\mu\text{F}$
Junction Temperature (T_J)	125°C
Operating Temperature Range (T_A)	-40°C to 85°C



ELECTRICAL SPECIFICATIONS

($V_{IN}=0.8V$ to $5.5V$, $V_{BIAS}=5V$, $C_{IN}=1\mu F$, $C_{OUT}=0.1\mu F$, $T_A=25^\circ C$, unless otherwise specified)

PARAMETER	SYM	TEST CONDITION	MIN	TYP	MAX	UNIT
Quiescent Current	I_{BIAS}	$V_{EN}=5V$, $I_{OUT}=0A$		30	50	μA
Shutdown Current	I_{SD}	$V_{EN}=GND$			1	μA
Under-Voltage Lockout	V_{UVLO}	Threshold	3.0	3.6	4.2	V
	V_{HYS}	Hysteresis		0.4		V
Switch ON Resistance	R_{ON}	$V_{EN}=V_{BIAS}$, $I_{OUT}=200mA$		40	50	$m\Omega$
Current Limit Threshold	I_{LM}		1.8			A
VO _{UT} Rise Time	t_{SS}	$V_{IN}=5V$		650		μs
Output Pull-Down Resistance	R_{OPD}	$V_{IN}=5V$, $V_{EN}=0V$		330	400	Ω
FLAG Delay Time ^(Note1)	t_{DELAY}	from fault condition to FLAG assert		3		ms
FLAG ON Resistance	R_{FLG}			20	50	Ω
EN Input Leakage Current	I_{EN}	$V_{EN}=5V$ or GND			1	μA
EN Threshold	V_{IH}	on	1.6			V
	V_{IL}	off			0.6	V
Thermal Shutdown Threshold ^(Note1)	T_{SD}			140		$^\circ C$
		Hysteresis		30		$^\circ C$

Note1: Guarantee by design, not production tested.



PIN DESCRIPTIONS

PIN No.	PIN SYMBOL	PIN DESCRIPTION
1	GND	Ground.
2	VIN	Input Power Supply.
3	VOUT	Switch output.
4	EN	Switch control input, active high. Do not leave floating.
5	VBIAS	Bias Voltage.
6	/FLG	Open-drain fault flag output.

BLOCK DIAGRAM

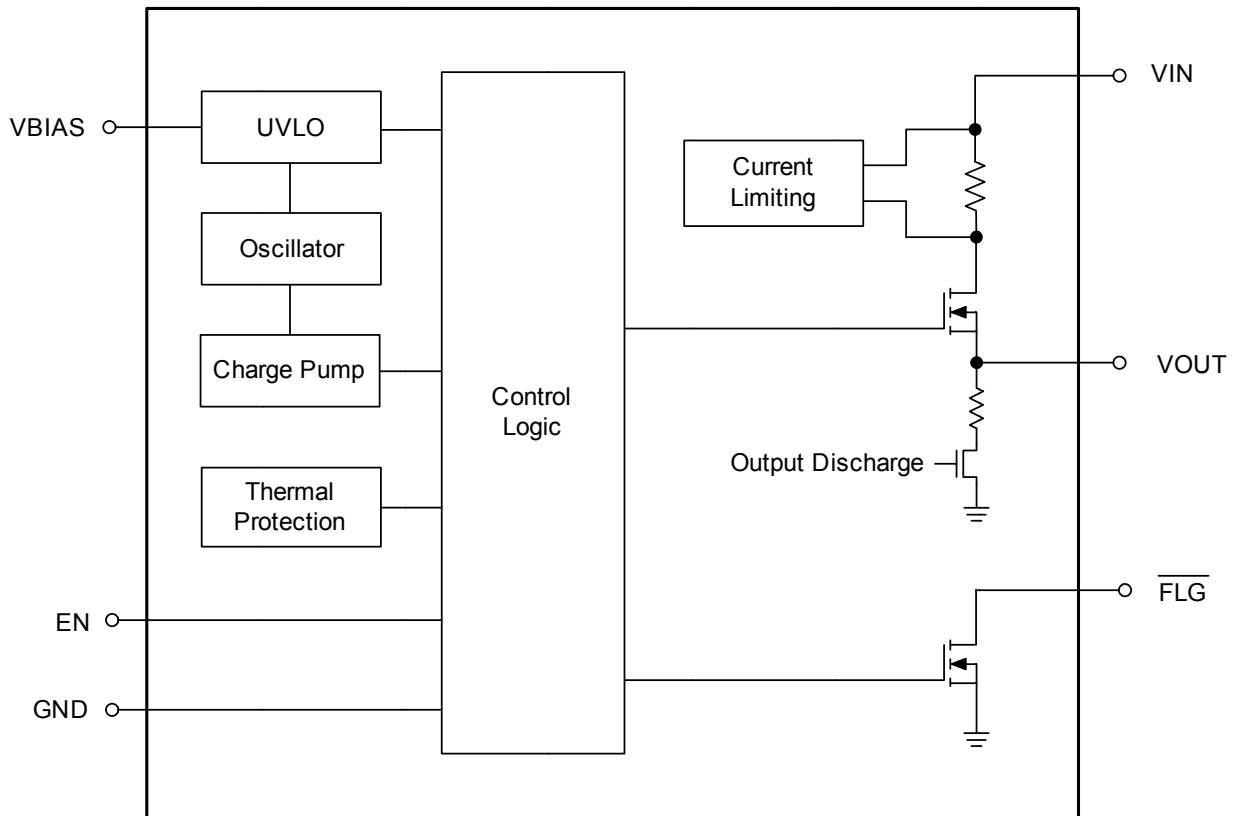



TYPICAL PERFORMANCE CHARACTERISTICS

C_{IN}=1μF, C_{OUT}=0.1μF, I_o=0A, ch1: V_{EN}, ch2: V_{OUT}, ch3: /FLG, ch4: I_{IN}

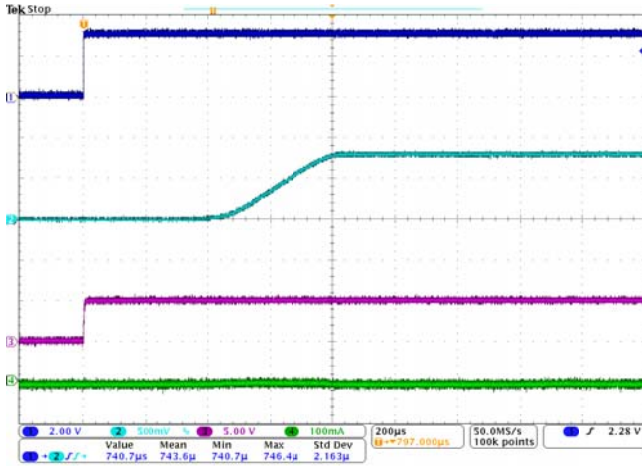

Fig.1 Turn-on Response, VIN=0.8V

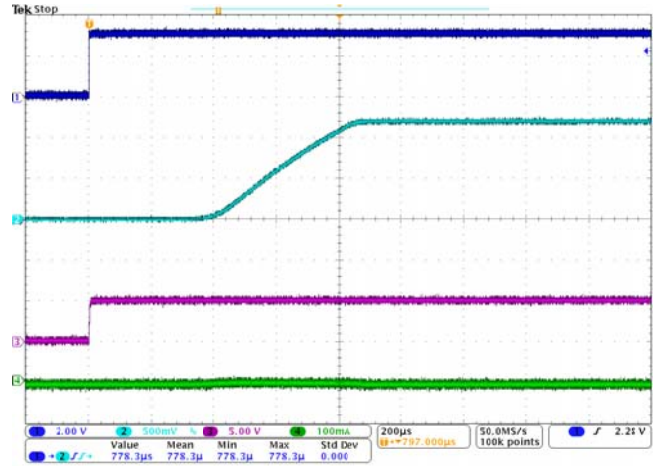

Fig.2 Turn-on Response, VIN=1.2V

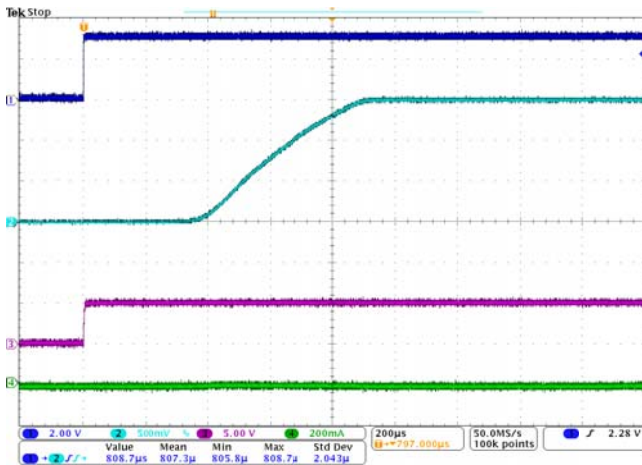

Fig.3 Turn-on Response, VIN=1.5V

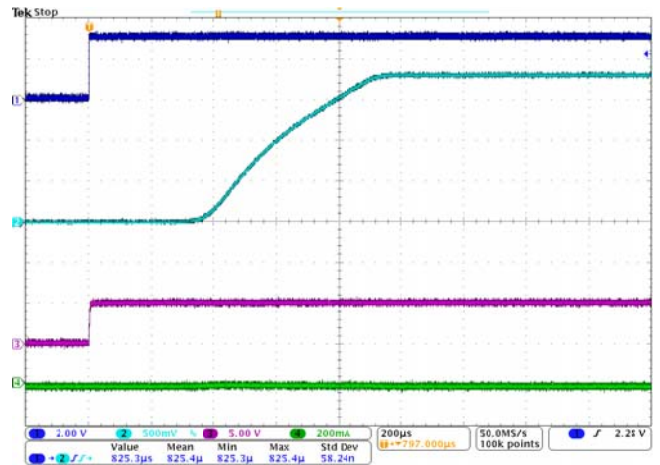

Fig.4 Turn-on Response, VIN=1.8V

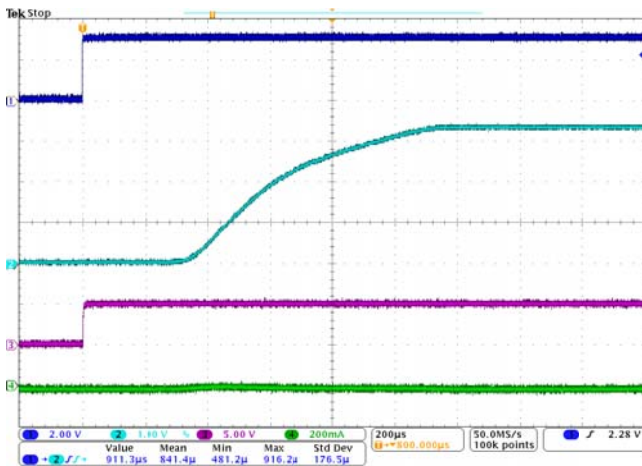

Fig.5 Turn-on Response, VIN=3.3V

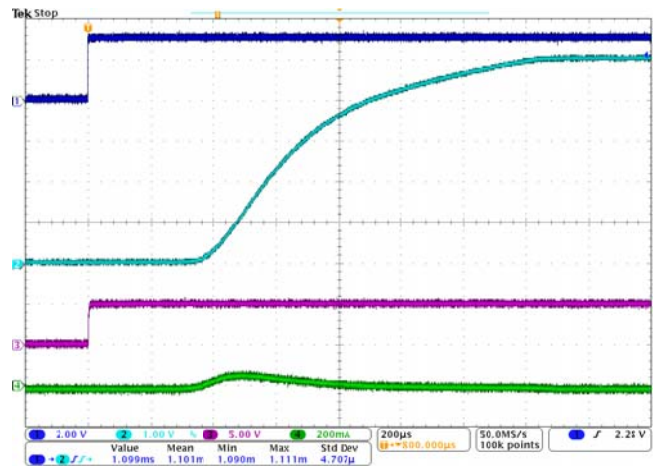

Fig.6 Turn-on Response, VIN=5.0V



TYPICAL PERFORMANCE CHARACTERISTICS (Continued)

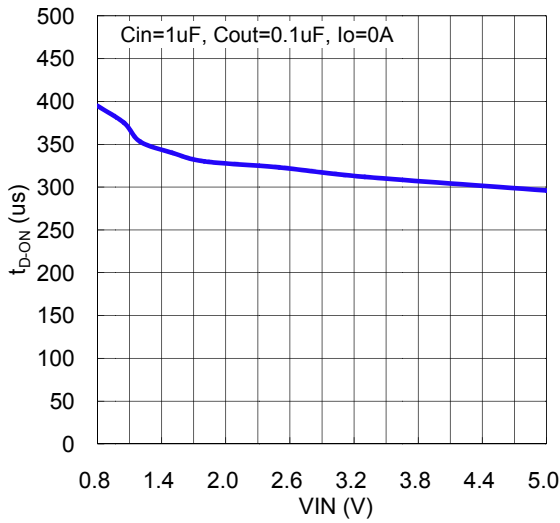

Fig.7 Turn-on Delay Time vs. VIN

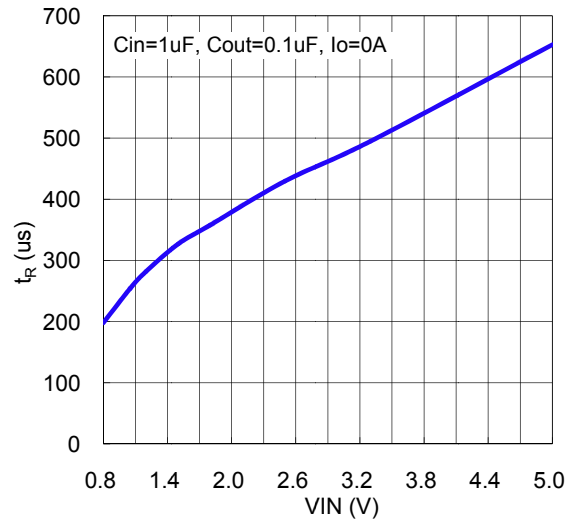

Fig.8 VOUT Rise Time vs. VIN

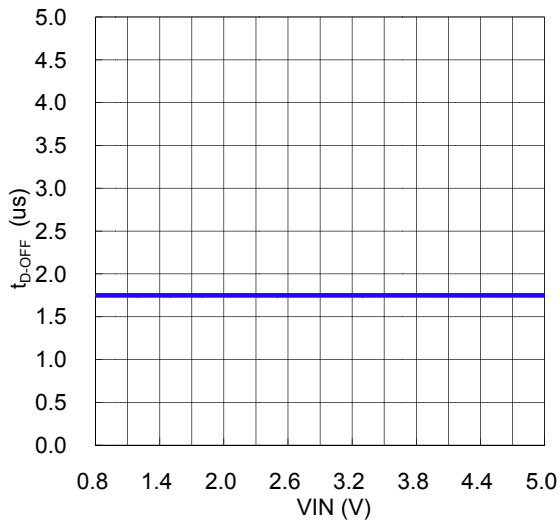

Fig.9 Turn-off Delay Time vs. VIN

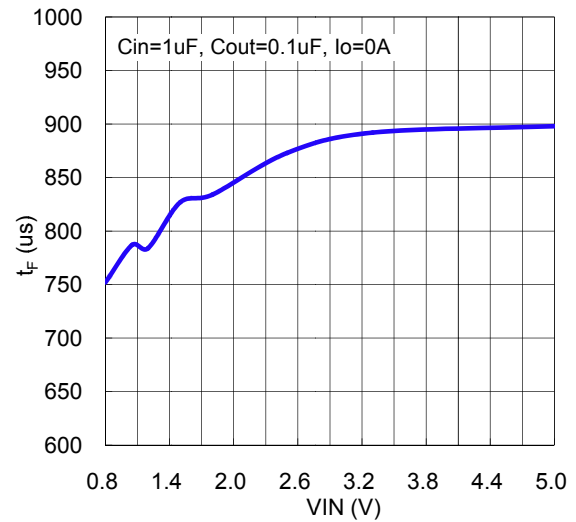

Fig.10 VOUT Fall Time vs. VIN

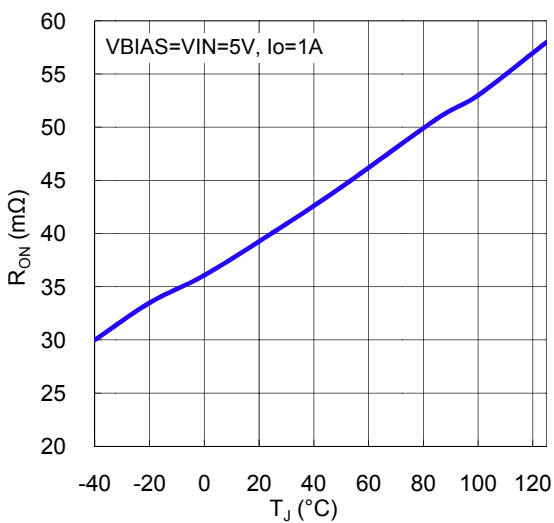

Fig.11 R_{ON} vs. Temperature

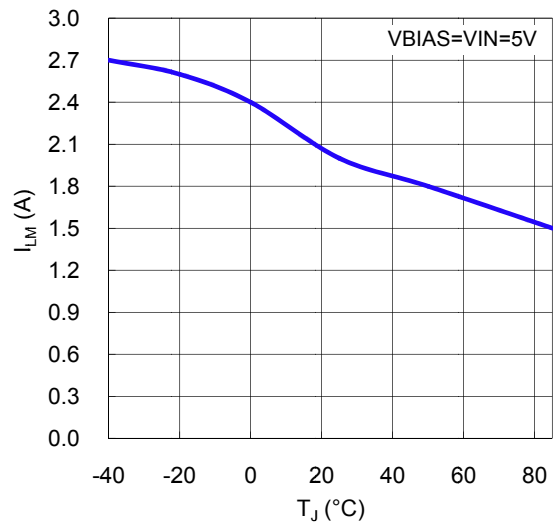

Fig.12 Current Limit vs. Temperature



TYPICAL PERFORMANCE CHARACTERISTICS (Continued)

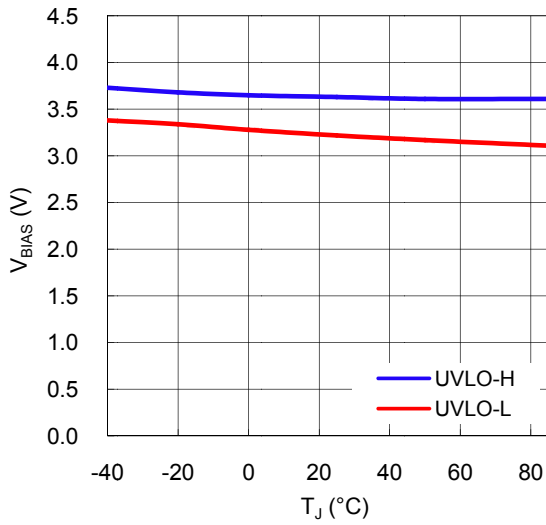

Fig.13 UVLO Threshold vs. Temperature

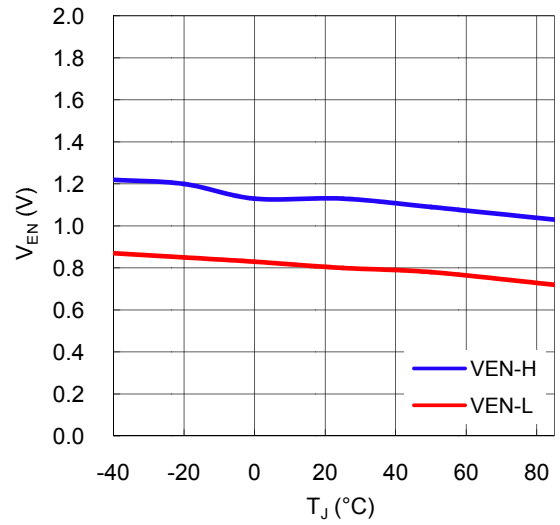

Fig.14 EN Threshold vs. Temperature

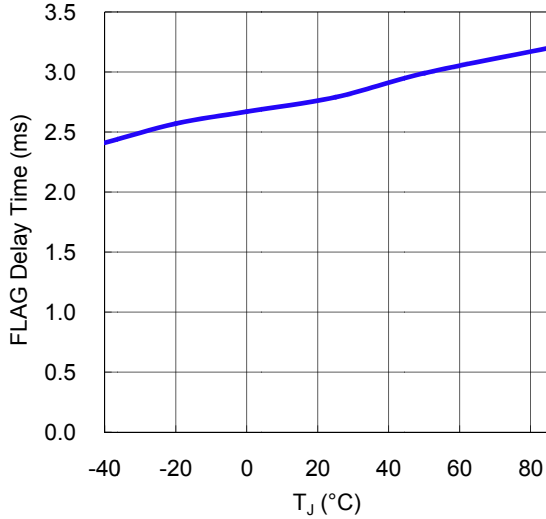

Fig.15 FLAG Delay Time vs. Temperature

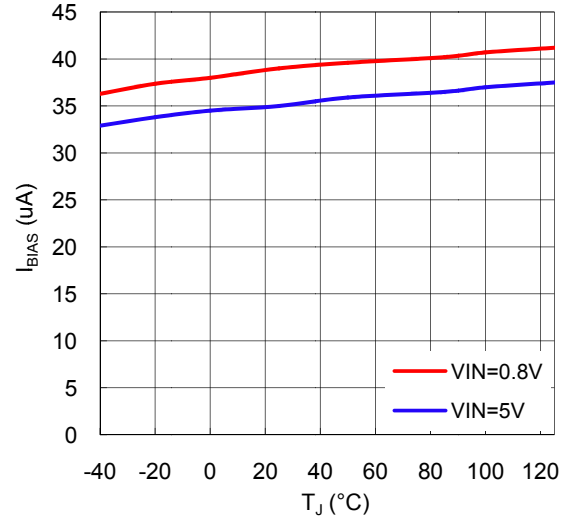

Fig.16 VBIAS Current vs. Temperature



APPLICATION INFORMATION

On/Off Control

The load switch is controlled by the EN pin. The EN pin is active high and has a low threshold making it capable of interfacing with low voltage signals. The EN pin can be used with standard 1.8V, 2.5V or 3.3V GPIO logic threshold. Do not leave the EN pin float.

The Figure17 shows the VOUT on/off definition.

t_{D-ON} : VOUT turn-on delay time

t_R : VOUT rise time

t_{D-OFF} : VOUT turn-off delay time

t_F : VOUT fall time

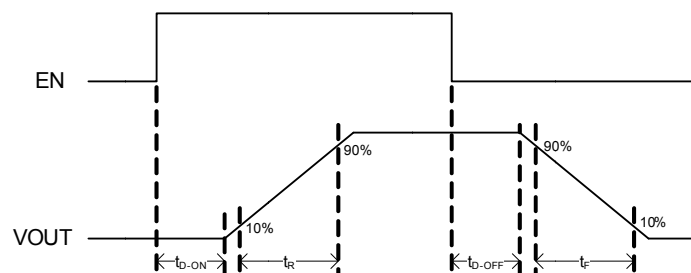

Fig.17 ON/OFF Waveform

FLAG Indicator

The APE8988 provides an error indicator (/FLAG) output, which is an open-drain output requiring a pull-up resistor. Typically connect to +5V bias supply through a 10k Ω resistor. The FLAG comparator continuously monitors the fault condition for over current, short circuit and thermal shutdown conditions. If the fault condition keeps for 3ms, /FLAG becomes low immediately.

Input Capacitor

An input capacitor is recommended to be placed between VIN and GND to limit the voltage drop on the input supply during high current application.

Output Capacitor

Setting a C_{IN} greater than the C_{OUT} is highly recommended. Since the internal body diode is in the NMOS switch, this prevents the current flows through the body diode from VOUT to VIN when the system supply is removed.



APPLICATION INFORMATION (Continued)

Layout Considerations

Follow the below guidelines for PCB layout to achieve stable operation. Take below figure for reference.

1. Keep the high current paths (VIN, VOUT and GND) wide and short to obtain the best effect.
2. The input and output capacitors should be close to the device as possible to minimize the parasitic trace inductances.

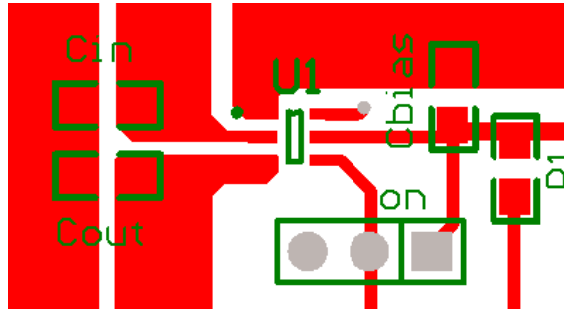
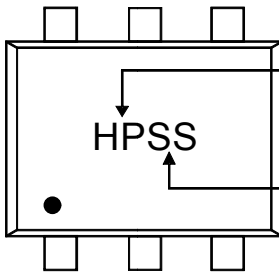

Fig.18 Reference layout



MARKING INFORMATION

SOT-26



Part Number : HP

Date Code

SS:2004, 2008, 2012...

SS:2003, 2007, 2011...

SS:2002, 2006, 2010...

SS:2001, 2005, 2009...