

MAX 10 FPGA Development Kit User Guide



Subscribe



Send Feedback

UG-01169
2017.09.07

101 Innovation Drive
San Jose, CA 95134
www.altera.com

ALTERA
now part of Intel

Contents

Overview.....	1-1
General Description.....	1-2
Handling the Board.....	1-4
Getting Started.....	2-1
Quartus II Web Edition Software.....	2-1
Installing the Development Kit.....	2-1
Installing the USB-Blaster Driver.....	2-2
Board Update Portal.....	2-2
Board Test System.....	3-1
Using the Configure Menu.....	3-3
The System Info Tab.....	3-5
The GPIO Tab.....	3-7
The Flash Tab.....	3-9
The HSMC Tab.....	3-11
The DDR3 Tab.....	3-13
The ADC Tab.....	3-15
The HDMI Tab.....	3-17
The Sleep Mode Tab.....	3-18
The Power Monitor.....	3-20
The Clock Control.....	3-22
Board Components.....	4-1
Board Overview.....	4-1
Featured Device.....	4-3
Configuration.....	4-4
Using the Quartus II Programmer.....	4-4
Selecting the Internal Configuration Scheme.....	4-4
Switch and Jumper Settings.....	4-5
Status Elements.....	4-7
Setup Elements.....	4-8
General User Input/Output.....	4-8
Clock Circuitry.....	4-9
On-Board Oscillators.....	4-10
Off-Board Clock Input/Output.....	4-11
Components and Interfaces.....	4-12
10/100/1000 Ethernet PHY.....	4-12
Digital-to-Analog Converter.....	4-15
HDMI Video Output.....	4-16

HSMC.....	4-17
Pmod Connectors.....	4-22
USB to UART.....	4-23
Memory.....	4-24
DDR3 Rev. B Board.....	4-24
DDR3 Rev. C Board.....	4-26
Flash.....	4-29
Power Distribution System.....	4-31
Additional Information.....	A-1
User Guide Revision History.....	A-1
Compliance and Conformity Statements.....	A-2
CE EMI Conformity Caution.....	A-2

2017.09.07

UG-01169



Subscribe



Send Feedback

The MAX[®] 10 FPGA development board provides a hardware platform for evaluating the performance and features of the Altera[®] MAX 10 device.

The development kit includes a RoHS- and CE-compliant MAX 10 FPGA Development board with the following components:

- Featured Devices:
 - MAX 10 FPGA (10M50D, dual supply, F484 package)
 - Enpirion[®] EN2342QI 4 A PowerSoC Voltage-Mode Synchronous Step-Down Converter with Integrated Inductor Enpirion
 - EN6337QI 3 A High-Efficiency PowerSoC DC-DC Step-Down Converters with Integrated Inductor
 - Enpirion EP5358xUI 600 mA PowerSoC DC-DC Step-Down Converters with Integrated Inductor
 - MAX II CPLD – EPM1270M256C4N (On-board USB-Blaster[™] II)
- Programming and Configuration:
 - Embedded USB-Blaster II (JTAG)
 - Optional JTAG direct via 10-pin header
- Memory Devices:
 - 64-Mx16 1 Gb DDR3 SDRAM with soft memory controller
 - 128-Mx8 1 Gb DDR3 SDRAM with soft memory controller
 - 512-Mb Quad serial peripheral interface (quad SPI) flash
- Communication Ports:
 - Two Gigabit Ethernet (GbE) RJ-45 ports
 - Ethernet Port A (Bottom)
 - Ethernet Port B (Top)
 - One mini-USB2.0 UART
 - One high-definition multimedia interface (HDMI) video output
 - One universal high-speed mezzanine card (HSMC) connector
 - Two 12-pin Digilent Pmod[™] compatible connectors

Intel Corporation. All rights reserved. Intel, the Intel logo, Altera, Arria, Cyclone, Enpirion, MAX, Nios, Quartus and Stratix words and logos are trademarks of Intel Corporation or its subsidiaries in the U.S. and/or other countries. Intel warrants performance of its FPGA and semiconductor products to current specifications in accordance with Intel's standard warranty, but reserves the right to make changes to any products and services at any time without notice. Intel assumes no responsibility or liability arising out of the application or use of any information, product, or service described herein except as expressly agreed to in writing by Intel. Intel customers are advised to obtain the latest version of device specifications before relying on any published information and before placing orders for products or services.

*Other names and brands may be claimed as the property of others.

ISO
9001:2008
Registered

ALTERA
now part of Intel

- Analog:
 - Two MAX 10 FPGA analog-to-digital converter (ADC) SMA inputs
 - 2x10 ADC header
 - Potentiometer input to ADC
 - One external 16 bit digital-to-analog converter (DAC) device with SMA output
- Clocking
 - 25 MHz single-ended, external oscillator clock source
 - Silicon labs clock generator with programmable frequency GUI
- Mini-USB cable for on-board USB-Blaster™ II
- 2A Power Supply and cord
- Free Quartus® II Web Edition design software (download software and license from website)
- Complete documentation
 - User manual, bill of materials, schematic, and board files

General Description

Figure 1-1: MAX 10 FPGA Board Components (Top)

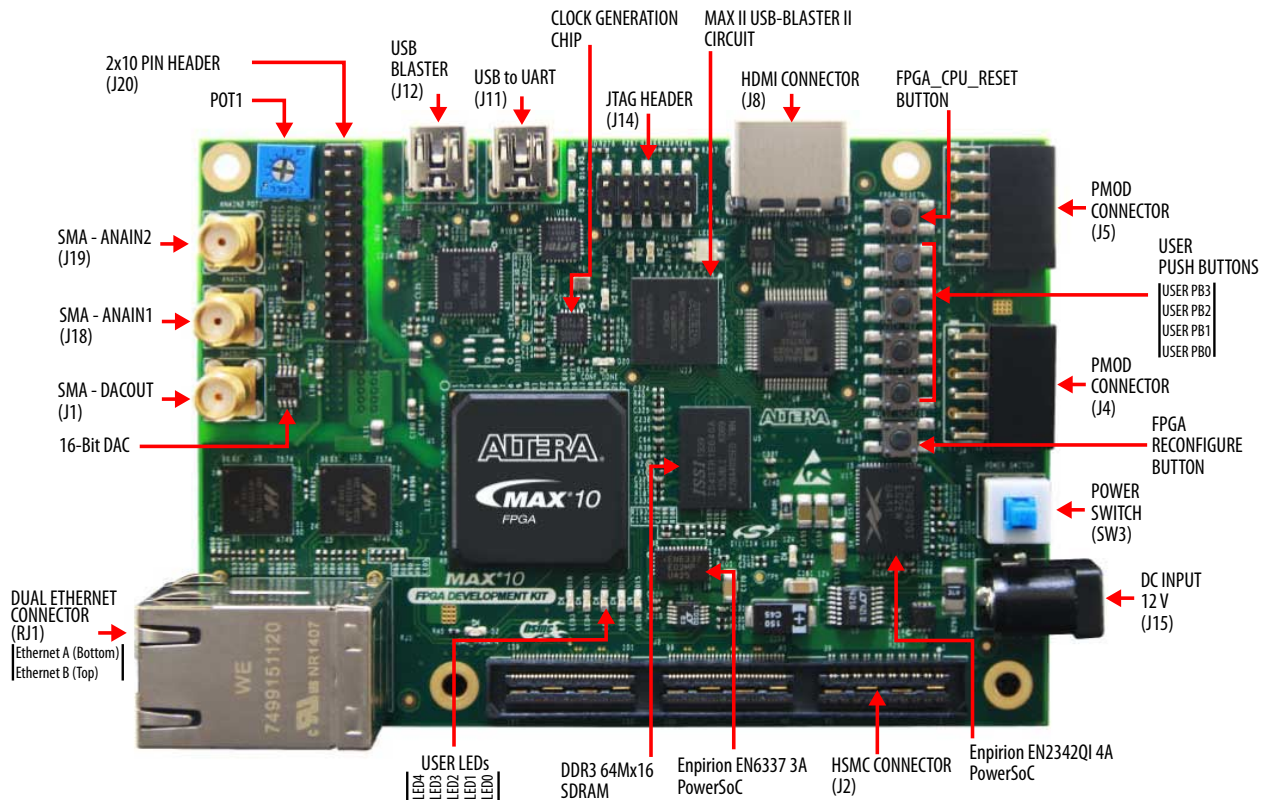

Figure 1-2: MAX 10 FPGA Board Components (Bottom)

Note: To determine the revision of your board, look for the serial number at the bottom of the board.

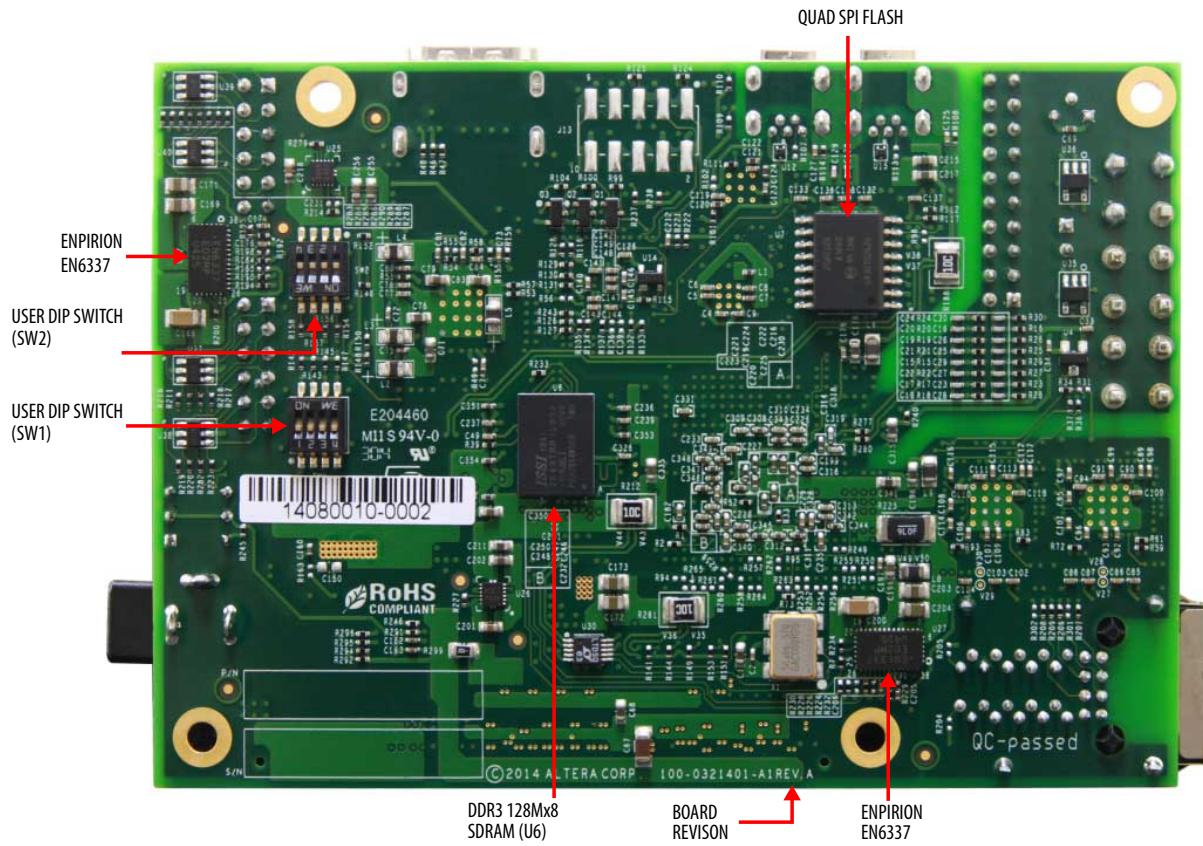
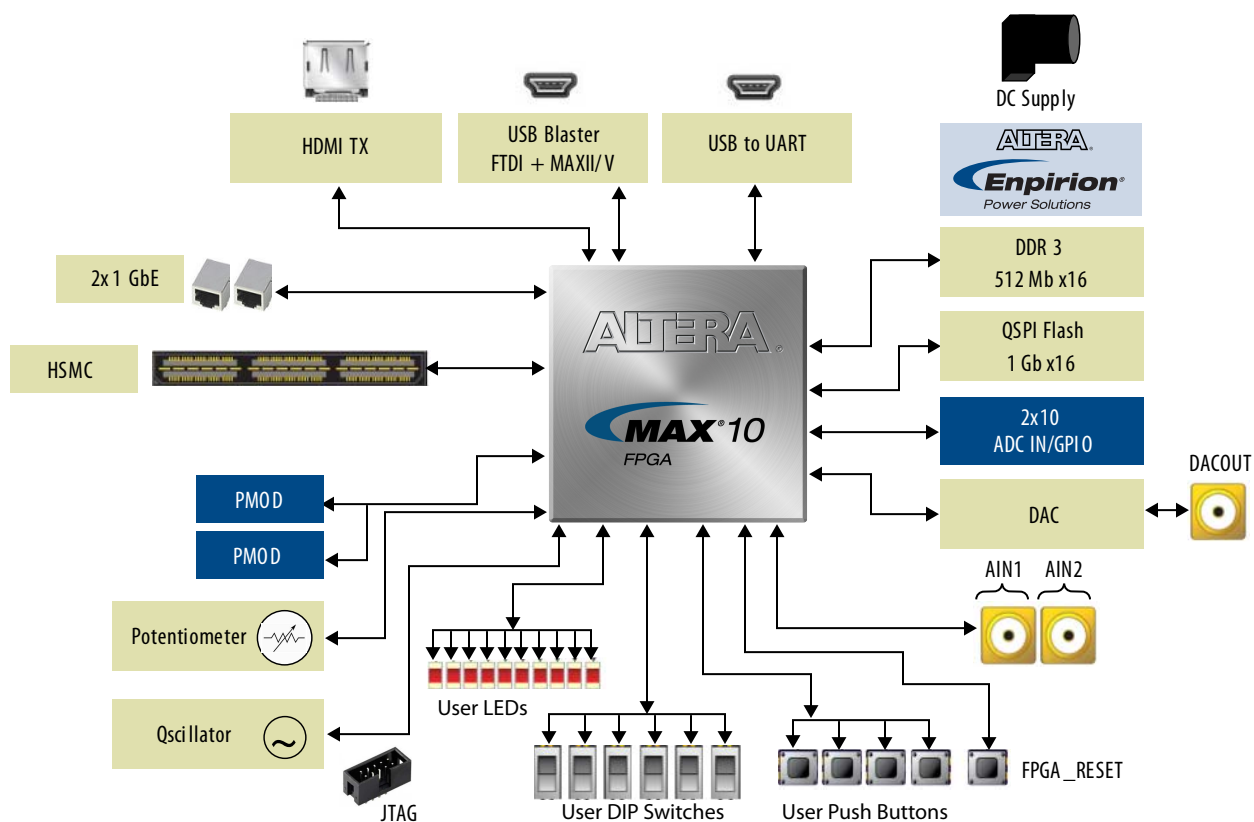

Figure 1-3: System Block Diagram



Handling the Board

When handling the board, it is important to observe static discharge precautions.

Caution: Without proper anti-static handling, the board can be damaged. Therefore, use anti-static handling precautions when touching the board.

Caution: This development kit should not be operated in a Vibration Environment.

2017.09.07

UG-01169



Subscribe



Send Feedback

Quartus II Web Edition Software

The Quartus II Web Edition Software is a free with no license required.

You can download the Web Edition software from the Altera website. Alternatively, you can request a DVD.

Related Information

- [Quartus II Web Edition Software](#)
- [Altera IP and Software DVD Request Form](#)
- [Altera Quartus II Software - Subscription Edition vs. Web Edition](#)

Installing the Development Kit

1. Download the MAX 10 Development Kit installer from the MAX 10 FPGA Development Kit page of the Altera website. Alternatively, you can request a development kit DVD from the Altera Kit Installations DVD Request Form page of the Altera website.
2. Run the MAX 10 FPGA Development Kit installer.
3. Follow the on-screen instructions to complete the installation process. Be sure that the installation directory you choose is in the same relative location to the Quartus II software installation. The installation program creates the development kit directory structure shown in the following figure.

Attention: .sof files are used by BTS GUI to configure the MAX 10 device and start corresponding test. Therefore, do not to move the .sof files from the `*\examples\board_test_system` directory.

Intel Corporation. All rights reserved. Intel, the Intel logo, Altera, Arria, Cyclone, Enpirion, MAX, Nios, Quartus and Stratix words and logos are trademarks of Intel Corporation or its subsidiaries in the U.S. and/or other countries. Intel warrants performance of its FPGA and semiconductor products to current specifications in accordance with Intel's standard warranty, but reserves the right to make changes to any products and services at any time without notice. Intel assumes no responsibility or liability arising out of the application or use of any information, product, or service described herein except as expressly agreed to in writing by Intel. Intel customers are advised to obtain the latest version of device specifications before relying on any published information and before placing orders for products or services.

*Other names and brands may be claimed as the property of others.

ISO
9001:2008
Registered

ALTERA
now part of Intel

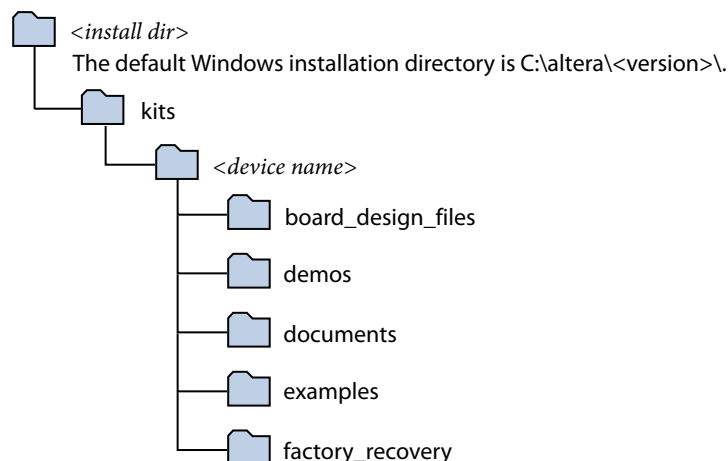
Figure 2-1: Installed Development Kit Directory Structure**Table 2-1: Installed Directory Contents**

Directory Name	Description of Contents
board_design_files	Contains schematic, layout, assembly, and bill of material board design files. Use these files as a starting point for a new prototype board design.
demos	Contains demonstration applications when available.
documents	Contains the following documentation: <ul style="list-style-type: none"> MAX 10 FPGA Development Kit User Guide Quick Start Guide Dear Customer Letter
examples	Contains the sample design files for this kit.
factory_recovery	Contains the original data programmed onto the board before shipment. Use this data to restore the board with its original factory contents.

Installing the USB-Blaster Driver

The development board includes integrated USB-Blaster circuitry for FPGA programming. However, for the host computer and board to communicate, you must install the On-Board USB-Blaster II driver on the host computer.

Installation instructions for the On-Board USB-Blaster II driver for your operating system are available on the Altera website. On the Altera Programming Cable Driver Information page of the Altera website, locate the table entry for your configuration and click the link to access the instructions.

Board Update Portal

You can keep your board current by accessing the Board Update Portal on www.altera.com.

This web site allows you access useful information and updated software and design examples for your board. For instructions on setting up your board to access the Board Update Portal, consult the printed *Quick Start Guide* that is included in the kit box.

2017.09.07

UG-01169



Subscribe



Send Feedback

This kit includes an application called the Board Test System (BTS).

The BTS provides an easy-to-use interface to alter functional settings and observe the results. You can use the BTS to test board components, modify functional parameters, observe performance, and measure power usage. While using the BTS, you reconfigure the FPGA several times with test designs specific to the functionality you are testing.

Intel Corporation. All rights reserved. Intel, the Intel logo, Altera, Arria, Cyclone, Enpirion, MAX, Nios, Quartus and Stratix words and logos are trademarks of Intel Corporation or its subsidiaries in the U.S. and/or other countries. Intel warrants performance of its FPGA and semiconductor products to current specifications in accordance with Intel's standard warranty, but reserves the right to make changes to any products and services at any time without notice. Intel assumes no responsibility or liability arising out of the application or use of any information, product, or service described herein except as expressly agreed to in writing by Intel. Intel customers are advised to obtain the latest version of device specifications before relying on any published information and before placing orders for products or services.

*Other names and brands may be claimed as the property of others.

ISO
9001:2008
Registered

Figure 3-1: Board Test System GUI

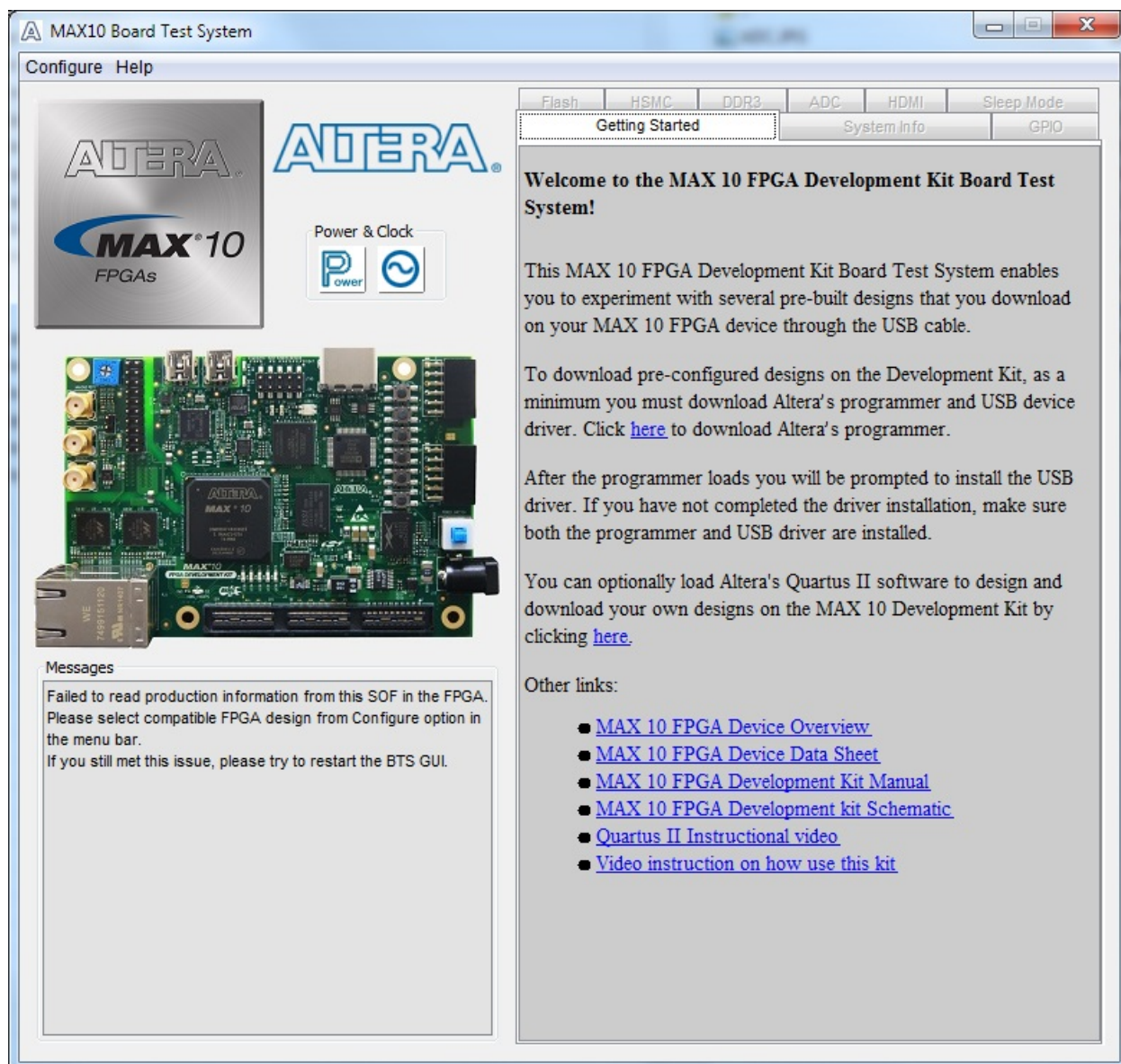

Several designs are provided to test the major board features. Each design provides data for one or more tabs in the application. The Configure menu identifies the appropriate design to download to the FPGA for each tab.

After successful FPGA configuration, the appropriate tab appears that allows you to exercise the related board features. Highlights appear in the board picture around the corresponding components

The BTS communicates over the JTAG bus to a test design running in the FPGA. The Board Test System and Power Monitor share the JTAG bus with other applications like the Nios II debugger and the SignalTap® II Embedded Logic Analyzer. Because the Quartus II programmer uses most of the bandwidth of the JTAG bus, other applications using the JTAG bus might time out. Be sure to close the other applications before attempting to reconfigure the FPGA using the Quartus II Programmer.

Using the Configure Menu

Use the Configure menu to select the design you want to use. Each design example tests different board features. Choose a design from this menu and the corresponding tabs become active for testing.

Figure 3-2: The Configure Menu

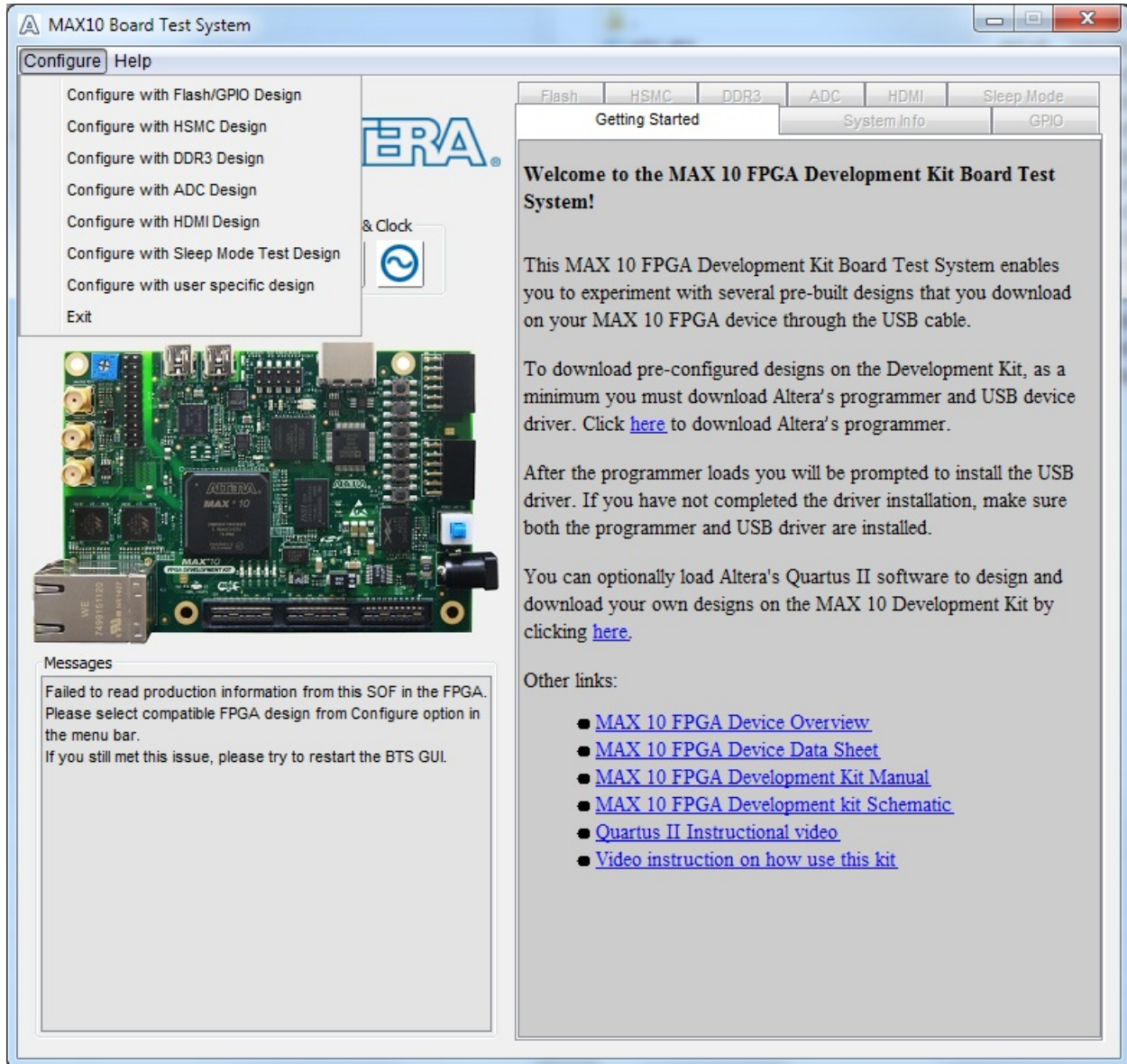

To configure the FPGA with a test system design, perform the following steps:

1. On the **Configure** menu, click the configure command that corresponds to the functionality you wish to test.
2. In the dialog box that appears, click **Configure** to download the corresponding design to the FPGA.
3. When configuration finishes, close the Quartus II Programmer if open. The design begins running in the FPGA. The corresponding GUI application tabs that interface with the design are now enabled.

If you use the Quartus II Programmer for configuration, rather than the Board Test System GUI, you may need to restart the GUI.

The System Info Tab

The System Info tab shows the board's current configuration. The tab displays the JTAG chain, the board's MAC address, the Qsys memory map, and other details stored on the board.

Figure 3-3: The System Info Tab

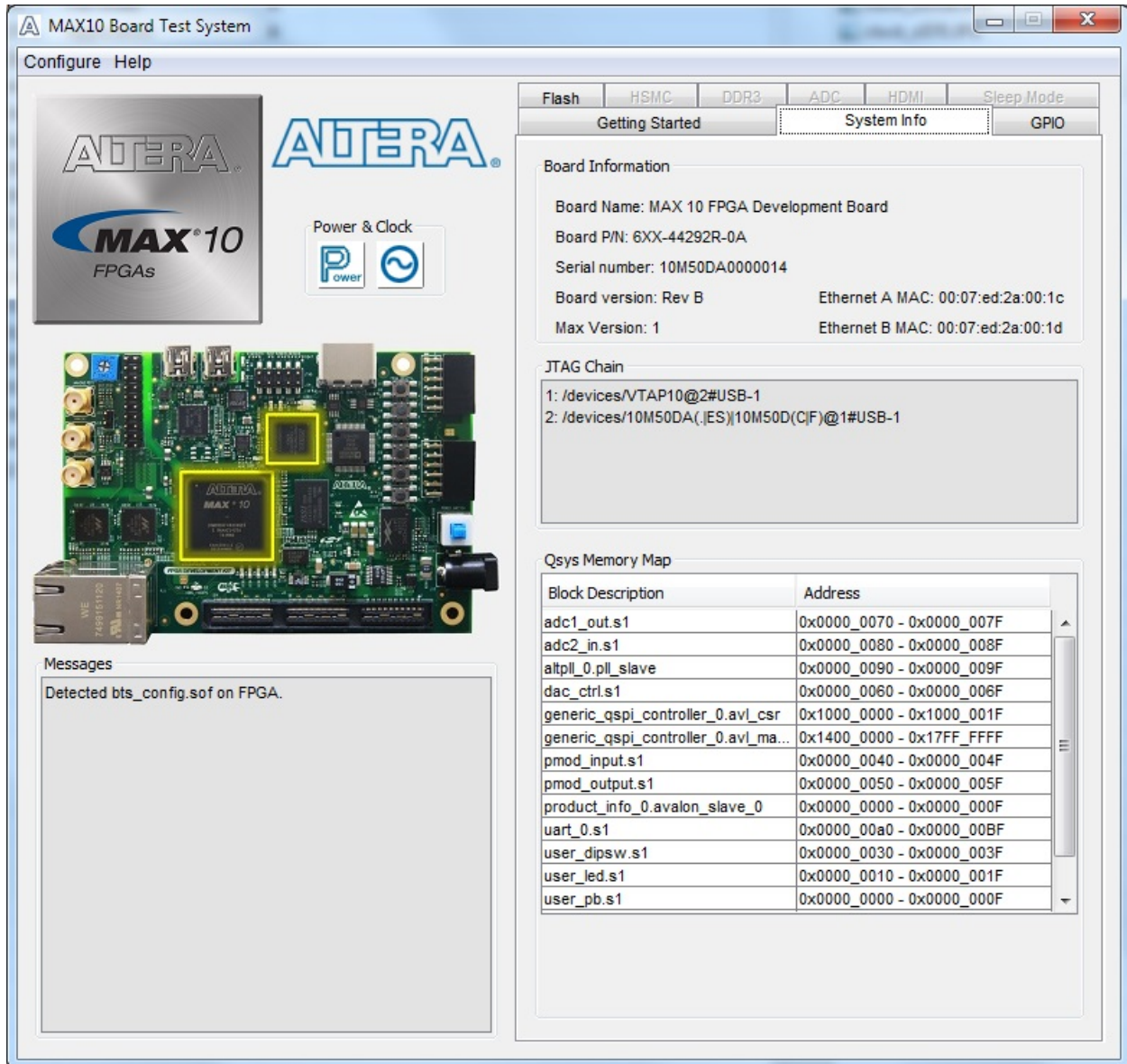

Table 3-1: Controls on the System Info Tab

Controls	Description
Board Information Controls	The board information is updated once the GPIO design is configured. Otherwise, this control displays the default static information about your board.
Board Name	Indicates the official name of the board, given by the Board Test System.
Board P/N	Indicates the part number of the board.
Serial Number	Indicates the serial number of the board.
Factory Test Version	Indicates the version of the Board Test System currently running on the board.
MAX Version	Indicates the version of MAX code currently running on the board.
Ethernet A MAC	Indicates the Ethernet A MAC address of the board.
Ethernet B MAC	Indicates the Ethernet B MAC address of the board.
JTAG Chain	Shows all the devices currently in the JTAG chain.
Qsys Memory Map	Shows the memory map of the Qsys system on your board.

The GPIO Tab

The GPIO tab allows you to interact with all the general purpose user I/O components on your board. You can read DIP switch settings, turn LEDs on or off, and detect push button presses.

Figure 3-4: The GPIO Tab



Table 3-2: Controls on the GPIO Tab

User DIP Switch	Displays the current positions of the switches in the user DIP switch banks. Change the switches on the board to see the graphical display change accordingly.
-----------------	--

User LEDs	Displays the current state of the user LEDs for the FPGA. To toggle the board LEDs, click the 0 to 4 buttons to toggle red or green LEDs, or click the All button.
Push Button Switches	Read-only control displays the current state of the board user push buttons. Press a push button on the board to see the graphical display change accordingly.

The Flash Tab

The **Flash Tab** allows you to read and write flash memory on your board.

Figure 3-5: The Flash Tab (Detail)

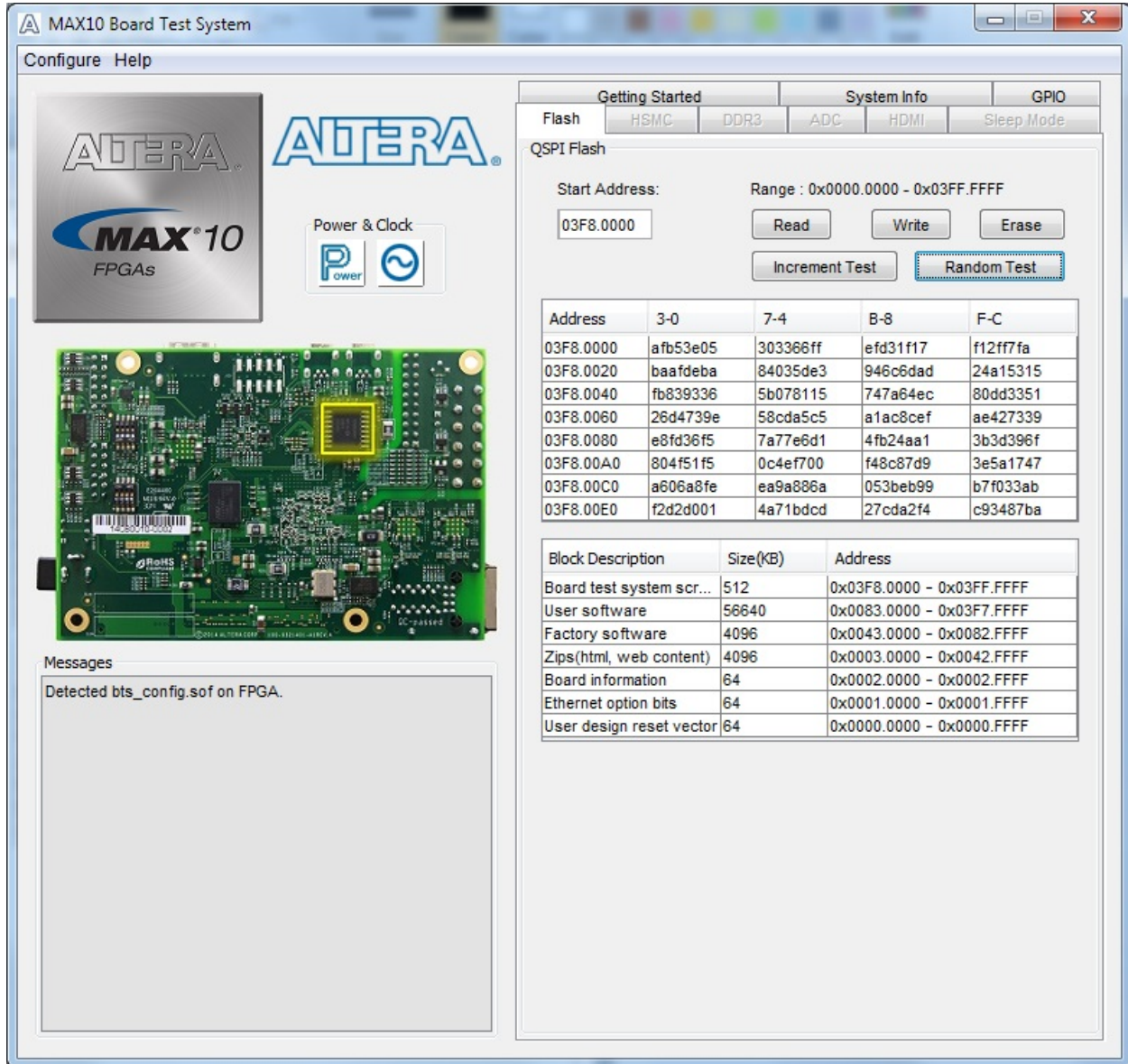

Control	Description
Read	Reads the flash memory on your board. To see the flash memory contents, type a starting address in the text box and click Read. Values starting at the specified address appear in the table.

Control	Description
Write	Writes the flash memory on your board. To update the flash memory contents, change values in the table and click Write. The application writes the new values to flash memory and then reads the values back to guarantee that the graphical display accurately reflects the memory contents.
Erase	Erases flash memory.
Increment Test	Starts an incrementing data pattern test to flash memory, limited to the 512 K test system scratch page.
Random Test	Starts a random data pattern test to flash memory, limited to the 512 K test system scratch page.
Flash Memory Map	Displays the flash memory map for the development board.

The HSMC Tab

The **HSMC Tab** allows you to test the CMOS port.

Figure 3-6: The HSMC Tab

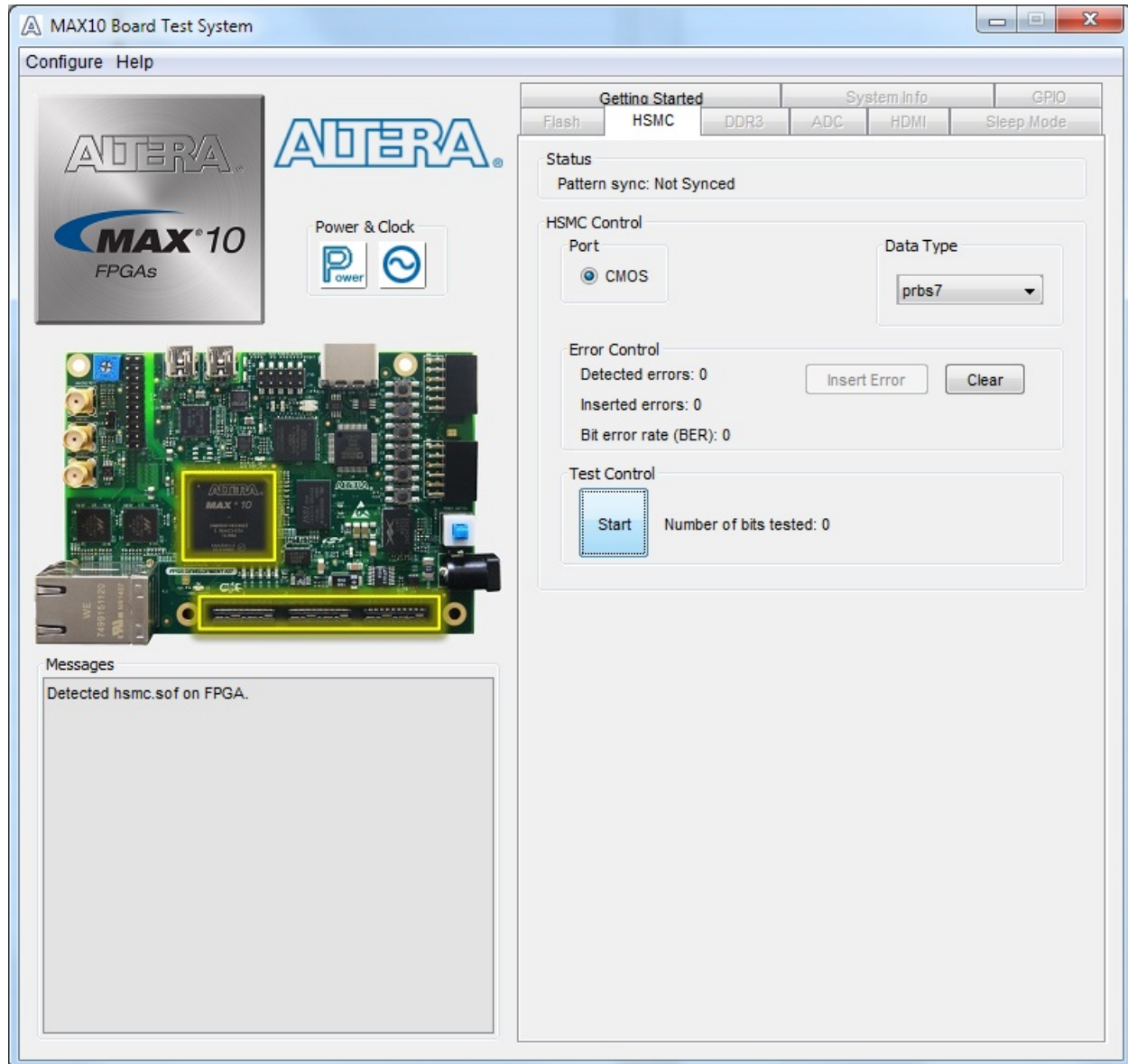

Control	Description
Status	Pattern sync: Shows the pattern synced or not synced state. The pattern is considered synced when the start of the data sequence is detected.
Port	CMOS: The CMOS port is available for tests.

Control	Description
Data Type	<p>The following data types are available for analysis:</p> <ul style="list-style-type: none"> • prbs7: Selects pseudo-random 7-bit sequences. • prbs15: Selects pseudo-random 15-bit sequences. • prbs23: Selects pseudo-random 23-bit sequences. • prbs31: Selects pseudo-random 31-bit sequences. • high_frequency: Divide by data pattern. • low_frequency: Divide by data pattern.
Error Control	<ul style="list-style-type: none"> • Detected errors: Displays the number of data errors detected in the hardware. • Inserted errors: Displays the number of errors inserted into the transmit data stream. • Bit error rate (BER): Displays the bit error rate of the interface • Insert Error: Inserts a one-word error into the transmit data stream each time you click the button. • Clear: Resets the Detected errors and Inserted errors counters to zeroes.
Test Control	<ul style="list-style-type: none"> • Stop: Resets the test. • Number of bits tested: Displays the number of bits tested since the last reset.

The DDR3 Tab

The **DDR3 Tab** allows you to test the DDR3 by reading and writing to a selected amount of addresses.

Figure 3-7: The DDR3 Tab

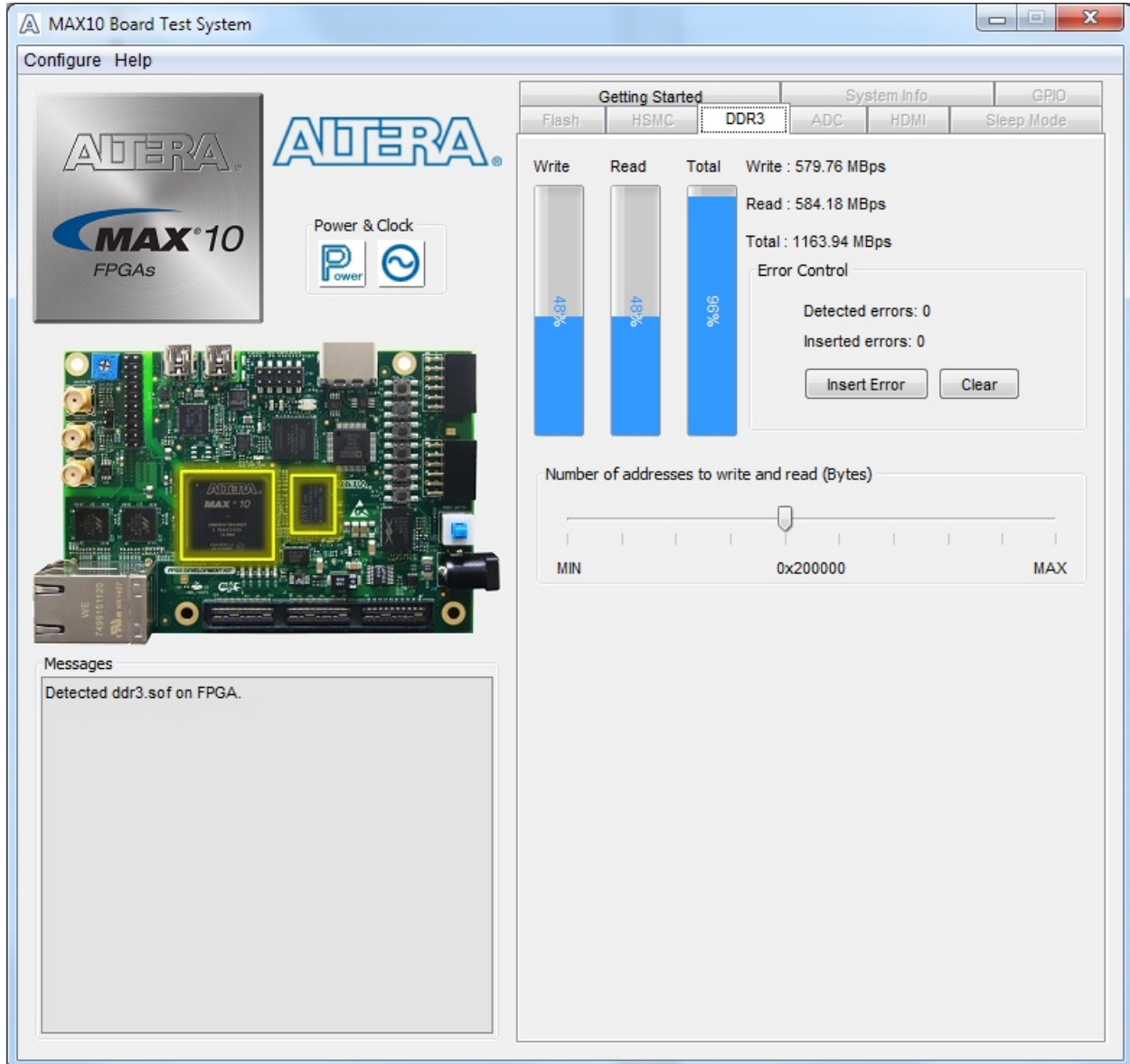

Control	Description
Performance Indicators	<p>These controls display current transaction performance analysis information collected since you last clicked Start:</p> <ul style="list-style-type: none"> • Write, Read, and Total performance bars—Show the percentage of maximum theoretical data rate that the requested transactions are able to achieve. • Write (MBps), Read (MBps), and Total (MBps)—Show the number of bytes of data analyzed per second. • Data bus: 72 bits (8 bits ECC) wide and the frequency is 1066 MHz double data rate. 2133 Megabits per second (Mbps) per pin. Equating to a theoretical maximum bandwidth of 136512 Mbps or 17064 MBps.
Error Control	<p>This control displays data errors detected during analysis and allows you to insert errors:</p> <ul style="list-style-type: none"> • Detected errors—Displays the number of data errors detected in the hardware. • Inserted errors—Displays the number of errors inserted into the transaction stream. • Insert Error—Inserts a one-word error into the transaction stream each time you click the button. Insert Error is only enabled during transaction performance analysis. • Clear—Resets the Detected errors and Inserted errors counters to zeroes.
Number of Addresses to Write and Read	Determines the number of addresses to use in each iteration of reads and writes.

The ADC Tab

The **ADC Tab** (analog-to-digital) shows the real-time voltage values of all of the ADC input channels.

Figure 3-8: The ADC Tab

The screenshot shows the 'MAX10 Board Test System' window. On the left, there is a logo for 'ALTERA MAX 10 FPGAs' and a 'Power & Clock' icon. Below this is an image of the MAX10 board with yellow boxes highlighting the ADC input channels. A 'Messages' box below the board image contains the text: 'Detected adc.sof on FPGA.'

The main area of the window is divided into two sections for ADC 1 and ADC 2. Each section contains a table with 'Channel ID' and 'DC Voltage (mv)' columns.

Channel ID	DC Voltage (mv)
Dedicated Channel	1250.610
Channel 0	809.937
Channel 1	869.141
Channel 2	828.857
Channel 3	476.685
Channel 4	374.146
Channel 5	411.987
Channel 6	302.124
Channel 7	316.162

Channel ID	DC Voltage (mv)
Dedicated Channel	1244.507
Channel 0	986.328
Channel 1	617.065
Channel 2	416.870
Channel 3	273.438
Channel 4	275.879
Channel 5	499.878
Channel 6	508.423
Channel 7	520.020

The two tables displayed on this tab, **ADC 1** and **ADC 2** are not editable. The following table shows where the channels connect to.

Dedicated Channel	SMA Connector
ADC 1	ANAIN1_SMA(J18)
Channel0	ADC1_CH0(J20.1)
Channel1	ADC1_CH1(J20.3)
Channel2	ADC1_CH2(J20.5)
Channel3	ADC1_CH2(J20.7)
Channel4	ADC1_CH4(J20.11)
Channel5	ADC1_CH4(J20.13)
Channel6	ADC1_CH6(J20.15 or POT1)
Channel7	ADC1_CH7(J20.17)

Dedicated Channel	SMA Connector
ADC 2	ANAIN2_SMA(J19)
Channel0	ADC1_CH0(J20.2)
Channel1	ADC1_CH1(J20.4)
Channel2	ADC1_CH2(J20.6)
Channel3	ADC1_CH2(J20.8)
Channel4	ADC1_CH4(J20.12)
Channel5	ADC1_CH4(J20.14)
Channel6	ADC1_CH6(J20.16)
Channel7	ADC1_CH7(J20.18)

The HDMI Tab

This tab displays a transmitter color bar pattern from the high-definition multimedia interface (HDMI).

Figure 3-9: The HDMI Tab

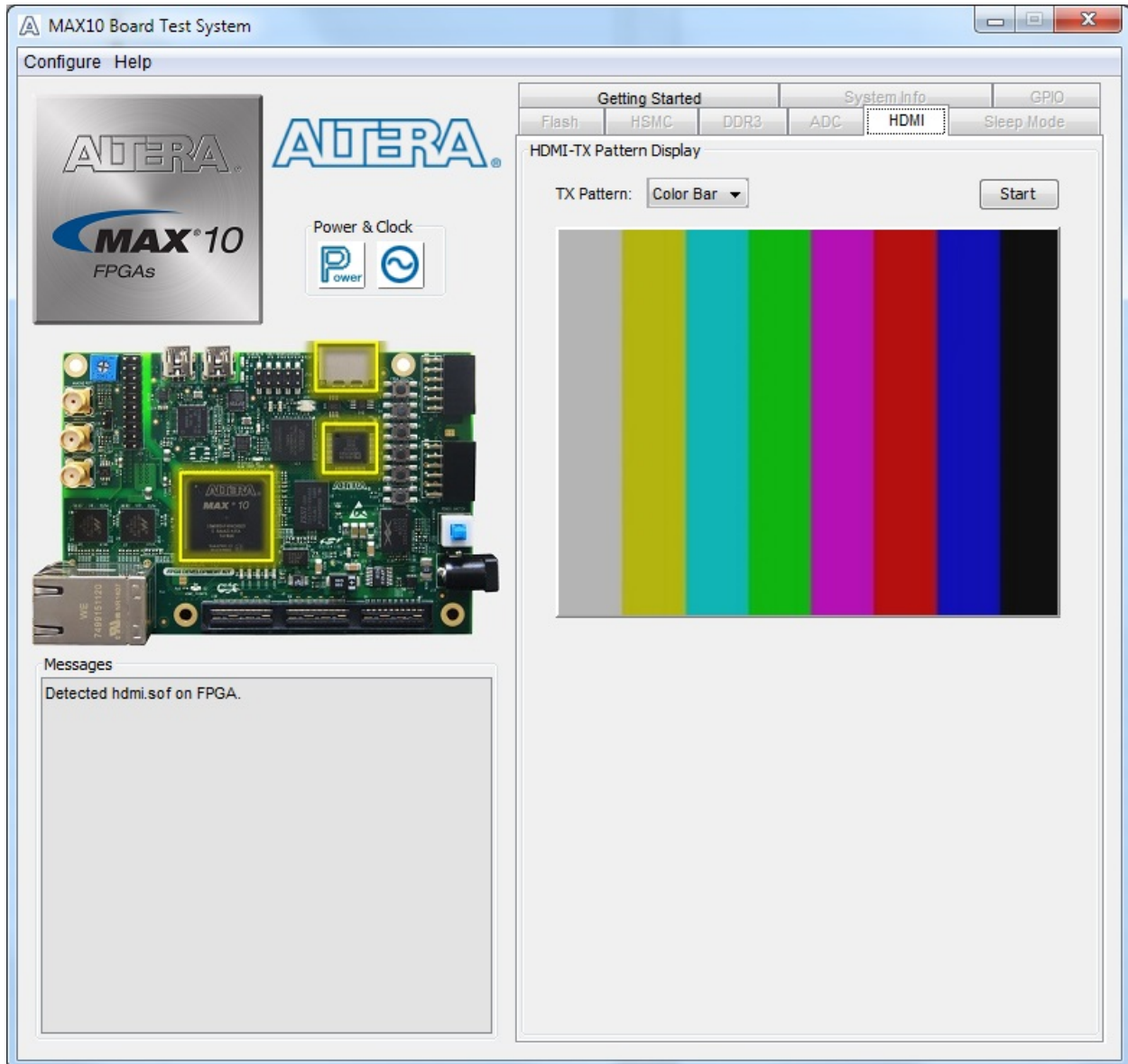

Control	Description
TX Pattern	Color Bar: Use this control to choose TX patterns. The available choices are red, blue, green, white, and black. If you select the Start button, the TX pattern displays immediately.
Start	When you click this button, the selected TX pattern (from Color Bar) displays.

The Sleep Mode Tab

This tab allows you to test the sleep mode aspect of the power management controller.

Figure 3-10: The Sleep Mode Tab (Cropped View)

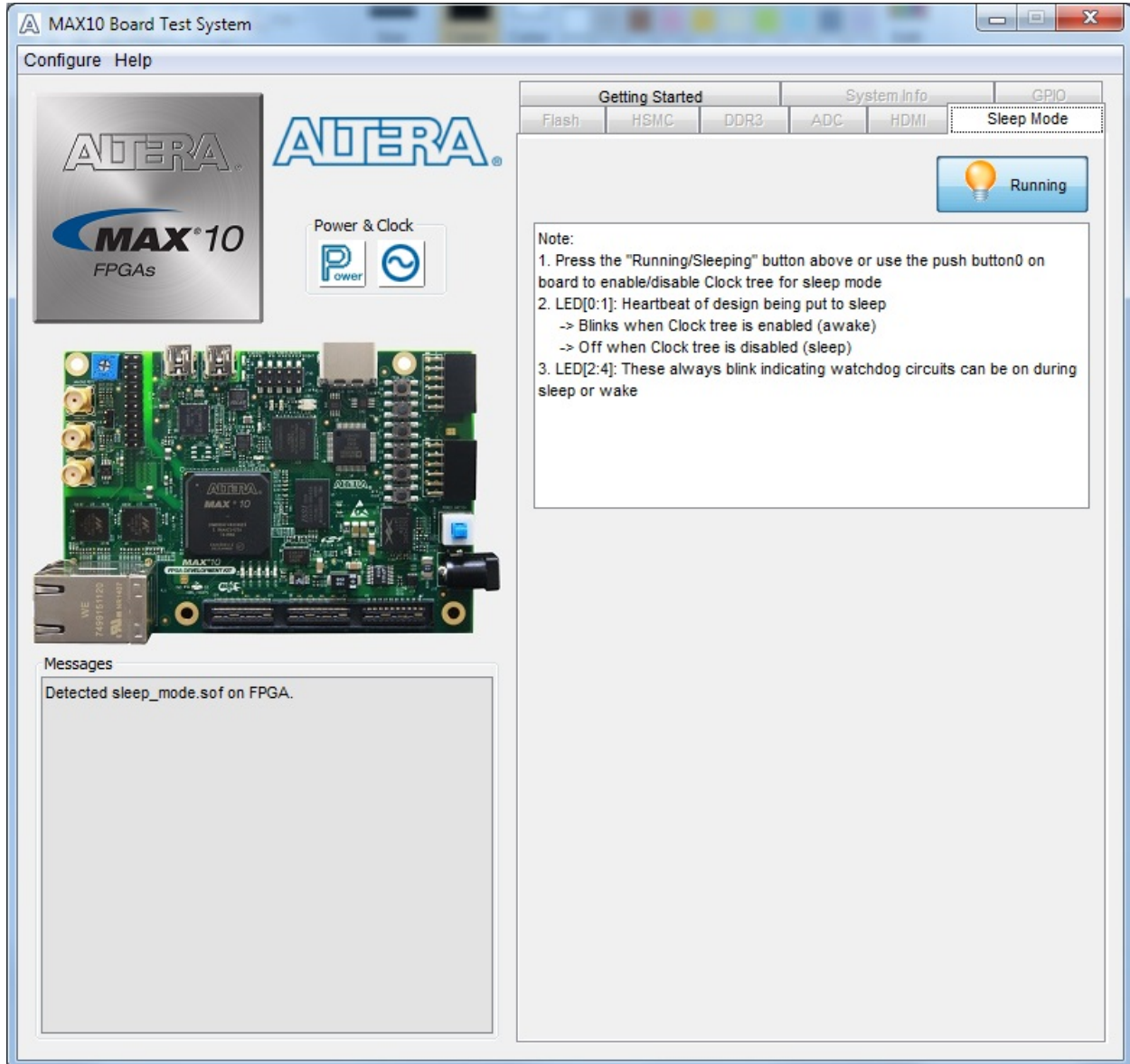

Control	Description
running (/sleeping)	This control displays the mode status as sleeping or running. It is not interactive.
Note	This control displays board LED events related to the sleep mode.

Related Information

[MAX 10 Power Management User Guide](#)

Provides details on the sleep mode.

The Power Monitor

The Power Monitor measures and reports current power information and communicates with the MAX II device on the board through the JTAG bus. A power monitor circuit attached to the MAX II device allows you to measure the power that the FPGA is consuming.

To start the application, click the Power Monitor icon in the Board Test System application. You can also run the Power Monitor as a stand-alone application. The `PowerMonitor(32-bit.exe)` and `PowerMonitor(64-bit.exe)` reside in the `<install_dir>\kits\<device_name>\examples\board_test_system` directory.

Note: You cannot run the stand-alone power application and the BTS application at the same time.

Figure 3-11: The Power Monitor

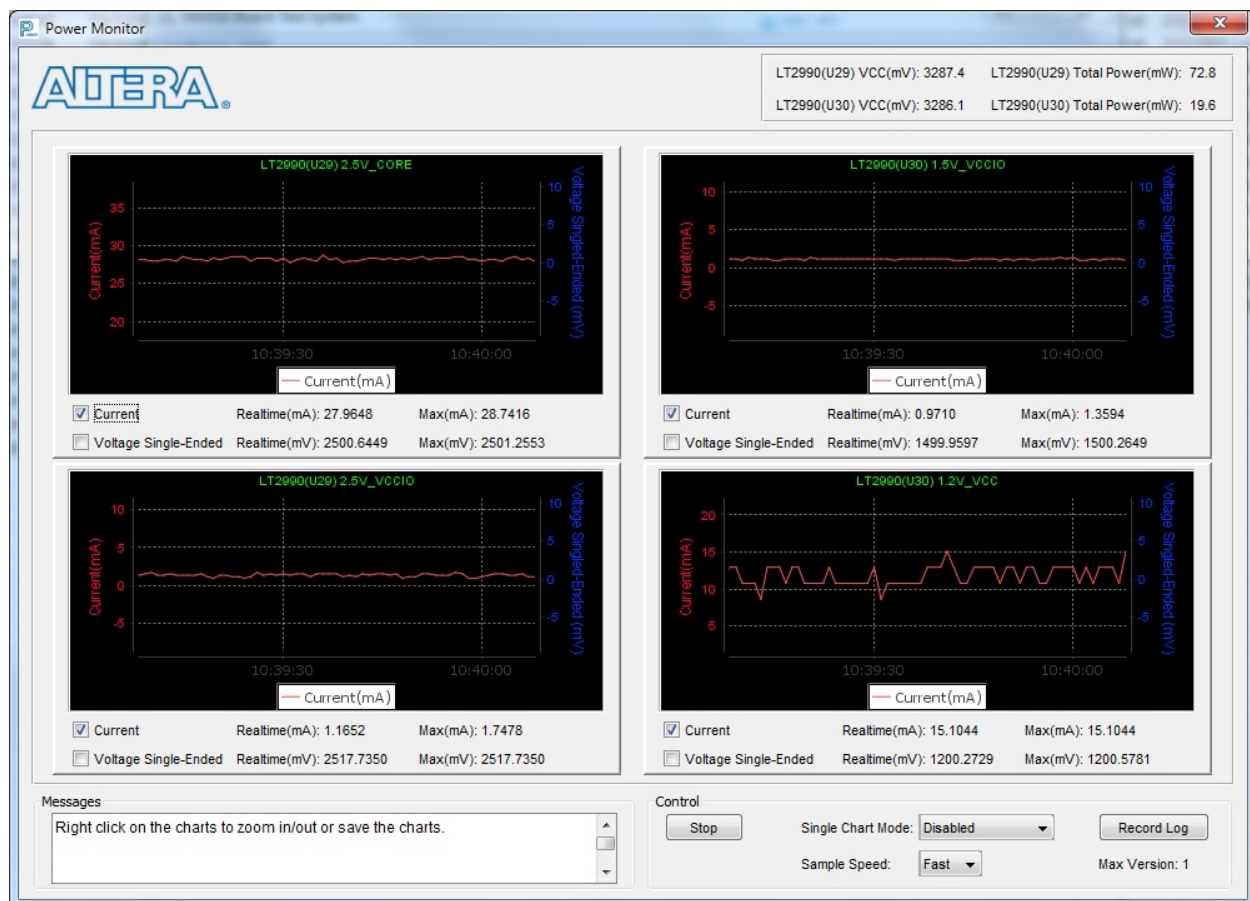

This window displays both LTC2990 current and temperature monitors. The left side top and bottom quadrant shows U29 and the opposite side shows U30. Use the available controls to show **Current** or **Voltage Single-Ended**, or both.

Single Chart Mode allows you to choose how you want the panes to display. You can show only a single large pane, if needed.

Voltage Single-Ended shows the voltage value of each power rail:

- 2.5 V_{CORE}
- 2.5 V_{VCCIO}
- 1.5 V_{VCCIO}
- 1.2 V_{VCC}

Single-ended shows the voltage of SENSE_P only.

The LT2990 also shows a differential voltage value of the sampling resistor SENSE_P and SENSE_N.

Sample Speed allows you to select **Slow** at 5 seconds, or **Fast**: at 1 second (default).

Record Log saves a comma-separated values (CSV) format file `ltc2990.csv` in the `*\examples\board_test_system` directory.

The Clock Control

The MAX 10 FPGA development board Clock Control application sets the programmable oscillators to any frequency between 10 MHz and 810 MHz. The frequencies support eight digits of precision to the right of the decimal point.

The Clock Control communicates with the MAX II device on the board through the JTAG bus. The programmable oscillators are connected to the MAX II device through a 2-wire serial bus.

Figure 3-12: The Si570 Tab

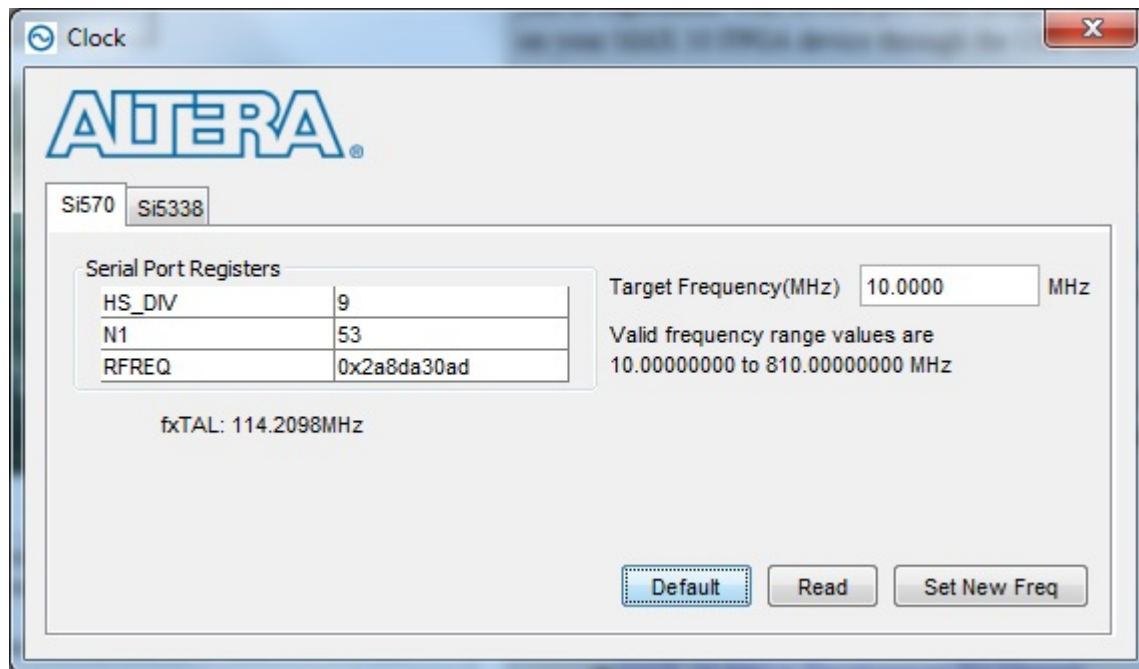

Control	Description
Serial Port Registers	Shows the current values from the Si570 registers for frequency configuration.
Target frequency (MHZ)	Allows you to specify the frequency of the clock. Legal values are between 10 and 810 MHz with eight digits of precision to the right of the decimal point. For example, 421.31259873 is possible within 100 parts per million (ppm). The Target frequency control works in conjunction with the Set New Freq control.
fXTAL	Shows the calculated internal fixed-frequency crystal, based on the serial port register values.
Default	Sets the frequency for the oscillator associated with the active tab back to its default value. This can also be accomplished by power cycling the board.
Read	Reads the current frequency setting for the oscillator associated with the active tab.

Control	Description
Set New Freq	Sets the programmable oscillator frequency for the selected clock to the value in the Target frequency control for the programmable oscillators. Frequency changes might take several milliseconds to take effect. You might see glitches on the clock during this time. Altera recommends resetting the FPGA logic after changing frequencies.

Figure 3-13: The Si5338 Tab

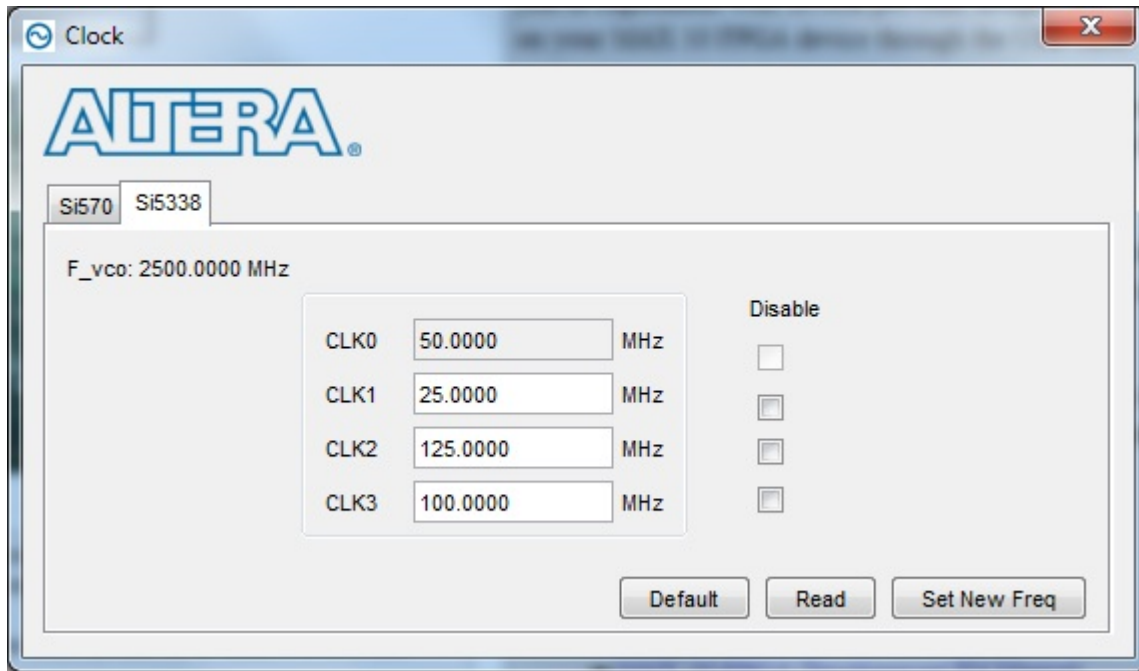

Control	Description
F_vco	Displays the generating signal value of the voltage-controlled oscillator.
Registers	Display the current frequencies for each oscillator.
Frequency (MHz)	Allows you to specify the frequency of the clock.
Disable	Disable each oscillators as required.
Read	Reads the current frequency setting for the oscillator associated with the active tab.
Default	Sets the frequency for the oscillator associated with the active tab back to its default value. This can also be accomplished by power cycling the board.

Control	Description
Set New Freq	<p>Sets the programmable oscillator frequency for the selected clock to the value in the CLK0 to CLK3 controls. Frequency changes might take several milliseconds to take effect. You might see glitches on the clock during this time. Altera recommends resetting the FPGA logic after changing frequencies.</p> <p>Note: Changing CLK0 of Si5338 will affect the Clock/Power GUI. One clock from port CLK0 is used to drive the MAX II device which as a 2-wire serial bus interface connected to SI570, Si5338, and the power monitor.</p>

2017.09.07

UG-01169



Subscribe



Send Feedback

This chapter introduces all the important components on the development kit board.

A complete set of schematics, a physical layout database, and GERBER files for the development board reside in the development kit documents directory.

Board Overview

This topic provides a high-level list of the major components of the MAX 10 FPGA development board.

Table 4-1: MAX 10 FPGA Board Components

Board Reference	Type	Description
Featured Devices		
U1	FPGA	MAX MAX 10 FPGA 10M50DAF484C6GES, 50K LEs, F484 package.
U13	CPLD	MAX II EPM1270 256-MBGA, 2.5 V/3.3 V, VCCINT for On-Board USB-Blaster II.
U17	Power Regulator	Enpirion® EN2342QI, PowerSoC voltage-mode synchronous step-down converter with integrated inductor.
U22, U23, U27	Power Regulator	Enpirion EN6337QI, PowerSoC DC-DC step-down converters with integrated inductor.
U26	Power Regulator	Enpirion EP5358LUI, 600 mA PowerSoC DC-DC step-down converters with integrated inductor.
U24, U25	Power Regulator	Enpirion EP5358HUI, 600 mA PowerSoC DC-DC step-down converters with integrated inductor.
Configuration and Setup Elements		
J12	On-Board (Embedded) USB-BlasterBlaster II	Type-B USB connector for programming and debugging the FPGA.

Intel Corporation. All rights reserved. Intel, the Intel logo, Altera, Arria, Cyclone, Enpirion, MAX, Nios, Quartus and Stratix words and logos are trademarks of Intel Corporation or its subsidiaries in the U.S. and/or other countries. Intel warrants performance of its FPGA and semiconductor products to current specifications in accordance with Intel's standard warranty, but reserves the right to make changes to any products and services at any time without notice. Intel assumes no responsibility or liability arising out of the application or use of any information, product, or service described herein except as expressly agreed to in writing by Intel. Intel customers are advised to obtain the latest version of device specifications before relying on any published information and before placing orders for products or services.

*Other names and brands may be claimed as the property of others.

ISO
9001:2008
Registered

ALTERA
now part of Intel

Board Reference	Type	Description
J14	10-pin header	Optional JTAG direct via 10-pin header for external download cables.
J20	2x10-pin header	16 dual-purpose ADC channels are connected to the 2x10 header.
SW2	DIP configuration and user switch	SW2 Includes switches to control boot images, JTAG bypass and HSMC bypass.
J7	Jumper for the MAX 10 ADC	Connects potentiometer for providing adjustable voltage to the ADC.
S5	Pulse_nconfig push button	Emulates pulsing the nCONFIG pin low to trigger reconfiguration even though the physical pin is unaffected.
S6	CPU reset push button	Default reset for the FPGA logic.
Status Elements		
D1	Blue power LED	Illuminates when 12-V power is present.
D2	Green high-speed mezzanine card (HSMC) LED	Illuminates when the HSMC is present.
D13, D14	Green USB-UART LEDs	Illuminates when the USB-UART transmitter and receiver are in use.
D20	Configuration done LED	Illuminates when the FPGA is configured.
D21, D22, D23	Power LEDs	Indicates that 3.3 V, 2.5 V, 1.2 V are powered up successfully.
Clock Circuitry		
X1	Programmable Clock for ADC	Programmable oscillator for ADC with default frequency of 10 MHz.
U2	Programmable Clock	Four channel programmable oscillator with default frequencies of 25, 50, 100, 125 MHz.
General User Input/Output		
S1, S2, S3, S4	General user push buttons	Four user push buttons. Driven low when pressed.
D15, D16, D17, D18, D19	User LEDs	Four user LEDs. Illuminates when driven low.
SW1, SW2.1	User DIP switches	Quad user DIP switches.
Memory Devices		
U5	DDR3 SDRAM A memory	64 Mx16.
U6	DDR3 SDRAM B memory	128 Mx8.
U7	Quad serial peripheral interface (quad SPI) flash	512 Mb.
Communication Ports		

Board Reference	Type	Description
J2	HSMC port	Provides 84 CMOS or 17 LVDS channels per HSMC specification.
U9, U10	Two Gigabit Ethernet ports <ul style="list-style-type: none"> Ethernet A (Bottom) Ethernet B (Top) 	RJ-45 connector which provides a 10/100/1000 Ethernet connection via a Marvell 88E1111 x 2 PHY and the FPGA-based Altera Triple Speed Ethernet MegaCore function in RGMII mode.
J4, J5	Two Diligent Pmod connectors	12-pin interface with 8 I/O signal pins used to connect low frequency, low I/O peripheral modules.
J11	Mini-USB 2.0 UART port	USB connector with USB-to-UART bridge for serial UART interface
J12	Mini-USB port	Embedded USB-Blaster II.
Analog		
J18, J19	SMA inputs	Two FPGA analog-to-digital converter (ADC).
J20	Header	2x10 ADC.
POT1	Potentiometer	Input to ADC.
J1	SMA output	External 16 bit digital-to-analog converter (DAC) device.
Video and Display Ports		
U8	HDMI video output	19-pin HDMI connector which provides a HDMI v1.4 video output of up to 1080p through an ADI (Analog Devices, Inc) PHY.
Power Supply		
J15	DC input jack	Accepts 12 V DC power supply.
SW3	Power switch	Switch to power on or off the board when power is supplied from the DC input jack.

Featured Device

The MAX 10 FPGA development board features the MAX 10 10M50DAF484C6GES device (U1) in a 484-pin FineLine BGA package.

Table 4-2: MAX 10 FPGA 10M50DAF484C6GES Features

ALMs	Equivalent LEs	M9K Memory (Kb)	Total RAM (Kb)	18-bit x 18-bit Multipliers	PLLs	Transceivers	Package Type
50,000	50	1,638	736	144	4	—	FineLine BGA 484 pins

Configuration

The MAX 10 FPGA development kit supports two configuration methods:

- Configuration by downloading a **.sof** file to the FPGA. Any power cycling of the FPGA or reconfiguration will power up the FPGA to a blank state.
- Programming of the on-die FPGA Configuration Flash Memory (CFM) via a **.pof** file. Any power cycling of the FPGA or reconfiguration will power up the FPGA in self-configuration mode, using the files stored in the CFM.

You can use two different USB-Blaster™ hardware components to program the **.sof** or **.pof** files:

- Embedded USB-Blaster II, type-B connector (J12).
- JTAG header (J14). Use an external USB-Blaster, USB-Blaster II, or Ethernet Blaster download cable. The external download cable connects to the board through the JTAG header (J14).

Using the Quartus II Programmer

You can use the Quartus II Programmer to configure the FPGA with a **.sof**.

Before configuring the FPGA:

- Ensure that the Quartus II Programmer and the USB-Blaster driver are installed on the host computer
- The USB cable is connected to the kit
- Power to the board is on, and no other applications that use the JTAG chain are running

To configure the MAX 10 FPGA:

1. Start the Quartus II Programmer.
2. Click **Add File** and select the path to the desired **.sof**.
3. Turn on the **Program/Configure** option for the added file.
4. Click **Start** to download the selected file to the FPGA. Configuration is complete when the progress bar reaches 100%.

The Quartus II Convert Programming File (CPF) GUI can be used to generate a **.sof** file that can use for internal configuration. You can directly program the MAX 10 device's flash which included Configuration Flash Memory (CFM) and User Flash Memory (UFM) by using a download cable with the Quartus II software programmer.

Selecting the Internal Configuration Scheme

For all MAX 10 devices, except 10M02 device, there are total of 5 different modes you can select internal configuration.

The internal configuration scheme needs to be selected before design compilation.

To select the configuration mode:

1. Open the Quartus II software and load a project using MAX 10 device family.
2. On the Assignments menu, click **Settings**. The **Settings** dialog box appears.
3. In the Category list, select **Device**. The Device page appears.
4. Click **Device and Pin Options**.
5. In the **Device and Pin Options** dialog box, click the **Configuration** tab.

6. In the **Configuration Scheme** list, select **Internal Configuration**.
7. In the **Configuration Mode** list, select 1 out of 5 configuration modes. For the dual-boot feature:
 - a. Must have a Dual Boot IP core in the design, for example, in a Qsys component.
 - b. Choose **Dual Compressed Images (512 Kbits UFM)** for the **Configuration Mode**.
 - c. Generate two sof files above and convert them into one POF file for CFM programming.
8. Turn on Generate compressed bitstreams if needed, and click **OK**.

Switch and Jumper Settings

This topic is for the MAX 10 FPGA development kit. This topic shows you how to restore the default factory settings and explains their functions.

The J7 jumper connects the output of potentiometer (POT1.2) to ADC1_CH6. When J7 jumper is on, you can use the potentiometer to provide adjustable voltage (0~2.5 V) to the MAX 10 ADC through ADC1_CH6. When J7 jumper is off, ADC1_CH6 is connected to the 2x10 header as the other ADC channels.

Figure 4-1: Jumper J7 on the Top of the Board (Detail)

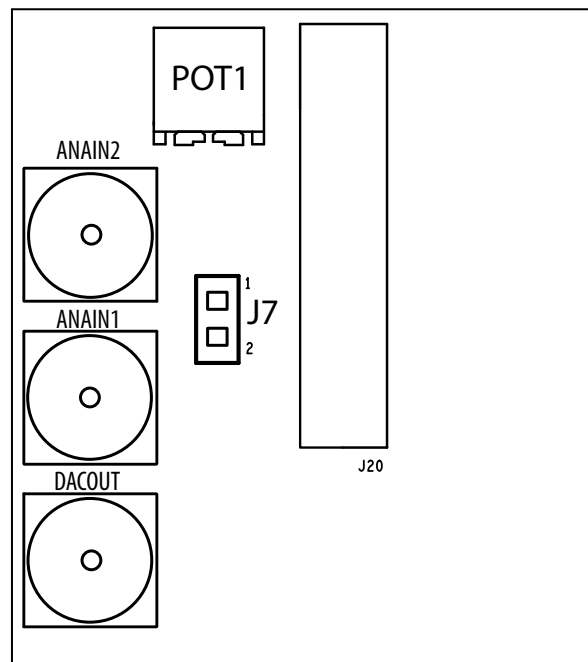

There are two switches on the bottom of the board. SW1 is for user functions, and SW2 allows for booting selection and bypassing some components.

Figure 4-2: Switches on the Bottom Board (Detail)

When a switch is ON, it means the FUNCTION SIGNAL is connected to GND. So it is a LOGIC LOW (0). When switch is OFF, it means the FUNCTION SIGNAL is disconnected from GND. So it is a LOGIC HIGH (1).

Note: The following figure shows the switch labels for the Rev. C board and a note for the Rev. B board. The change of name for SW2.3 is just a name change, not a functional change. Rev. B is labeled MAX10_BYPASSN, but it is actually a VTAP bypass.

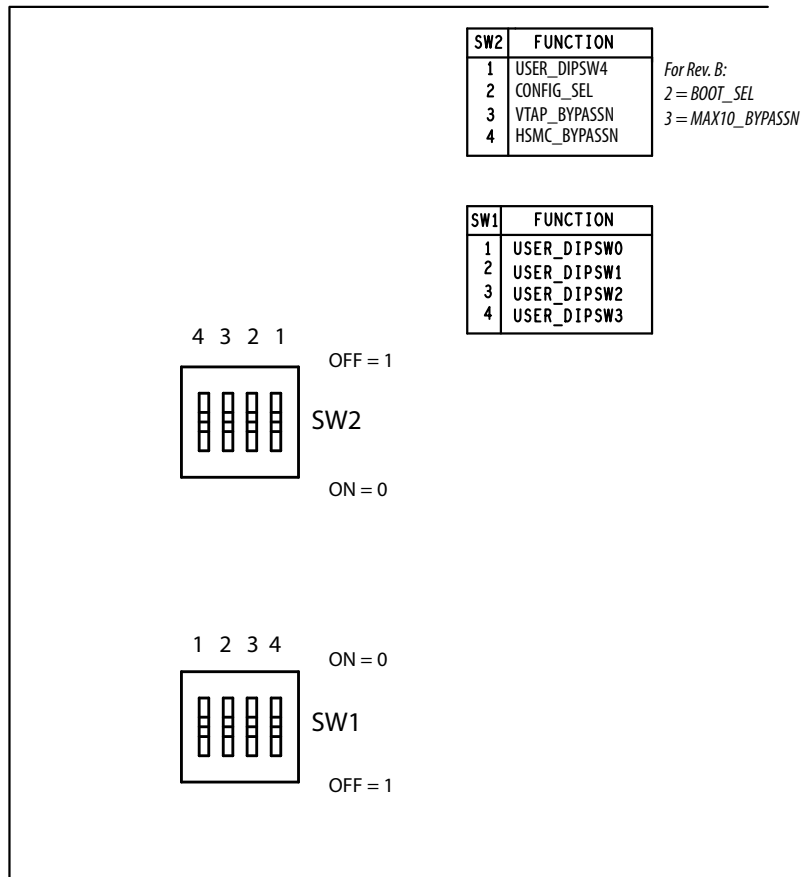
**Table 4-3: SW2 DIP Switch Settings (Board Bottom)**

Switch	Board Label	Function	Default Position
1	USER_DIPSW4	User defined switch #4, #0/1/2/3 is on SW1. No default function.	—
2	BOOT_SEL (for Rev. B Board) CONFIG_SEL (for Rev. C board)	Use this pin to choose CFM0, CFM1 or CFM2 image as the first boot image in dual-image configuration. If the CONFIG_SEL is set to low, the first boot image is CFM0 image. If the CONFIG_SEL pin is set to high, the first boot image is CFM1 or CFM2 image. This pin is read before user mode and before the nSTATUS pin is asserted.	LOW

Switch	Board Label	Function	Default Position
3	VTAP_BYPASSN	A virtual JTAG device is provided within the On-Board USB-Blaster II, it provides access to diagnostic hardware and board identification information. The device shows up as an extra device on the JTAG chain with ID: 020D10DD. This switch removes the virtual JTAG device from the JTAG chain.	HIGH
4	HSMC_BYPASSN	Use this pin to bypass HSMC from JTAG chain. The default value of this signal is high so HSMC is in the JTAG chain. (However, there is no daughter cards connected to HSMC normally so it would not be detected by JTAG master). When it is set to low, HSMC is bypassed.	HIGH

Status Elements

This topic lists the non-user status elements for the MAX 10 FPGA development board.

Table 4-4: General LED Signal Names

Board Reference	Signal Name	Description
D1	—	Blue Power LED
D2	HSMC_PRSENTn	Green LED
D13	UART_TXLED	Green LED for USB to UART
D14	UART_RXLED	Green LED for USB to UART

Table 4-5: MAX II CPLD LED Signal Names

Board Reference	Signal Name	I/O Standard	MAX II CPLD Pin Number
D20	MAXII_CONF_DONE	3.3 V	W17
D21	3.3V_LED	3.3 V	U4
D22	2.5V_LED	3.3 V	U5
D23	1.2V_LED	3.3 V	U6

Setup Elements

Table 4-6: Board Settings DIP Switch and Jumper Schematic Signals

Board Reference	Signal Name	Device / Pin Number	I/O Standard
SW2.1	USER_DIPSW4	MAX 10 / H21	1.5 V
SW2.2	CONFIG_SEL	MAX 10 / H10	3.3 V
SW2.3	VTAP_BYPASSN	MAX II / P17	3.3 V
SW2.4	HSMC_BYPASSn	MAX II / P18	3.3 V
J7.1	—	POT1	2.5 V
J7.2	ADC1_CH6	2x10 Header / J20.15	2.5 V

Table 4-7: General Push Button Signal Names

Board Reference	Signal Name	MAX 10 FPGA Pin Number	I/O Standard
S5	PULSE_NCONFIG	H9	3.3 V
S6	CPU_RESETh	D9	3.3 V

General User Input/Output

User-defined I/O signal names, FPGA pin numbers, and I/O standards for the MAX 10 FPGA development board.

Table 4-8: User-Defined Push Button Signal Names

Board Reference	Signal Name	MAX 10 FPGA Pin Number	I/O Standard
S1	USER_PB0	L22	1.5 V
S2	USER_PB1	M21	1.5 V
S3	USER_PB2	M22	1.5 V
S4	USER_PB3	N21	1.5 V

Table 4-9: User-Defined DIP Switch Schematic Signal Names

Board Reference	Signal Name	MAX 10 FPGA Pin Number	I/O Standard
SW1.1	USER_DIPSW0	H21	1.5 V

Board Reference	Signal Name	MAX 10 FPGA Pin Number	I/O Standard
SW1.2	USER_DIPSW1	H22	1.5 V
SW1.3	USER_DIPSW2	J21	1.5 V
SW1.4	USER_DIPSW3	J22	1.5 V
SW2.1	USER_DIPSW4	G19	1.5 V

Table 4-10: User LED (Green) Schematic Signal Names

Board Reference	Signal Name	MAX 10 FPGA Pin Number	I/O Standard
D15	USER_LED0	T20	1.5 V
D16	USER_LED1	U22	1.5 V
D17	USER_LED2	U21	1.5 V
D18	USER_LED3	AA21	1.5 V
D19	USER_LED4	AA22	1.5 V

For a MAX 10 Development Kit Baseline Pinout design visit the Altera Design Store.

Related Information

[Altera Design Store \(MAX 10 Development Kit\)](#)

Clock Circuitry

The development board includes a four channel programmable oscillator with default frequency of 25-MHz, 50-MHz, 100-MHz, 125-MHz. The board also includes a 10-MHz programmable oscillator connected to the ADC.

On-Board Oscillators

Figure 4-3: MAX 10 FPGA Development Board Clocks

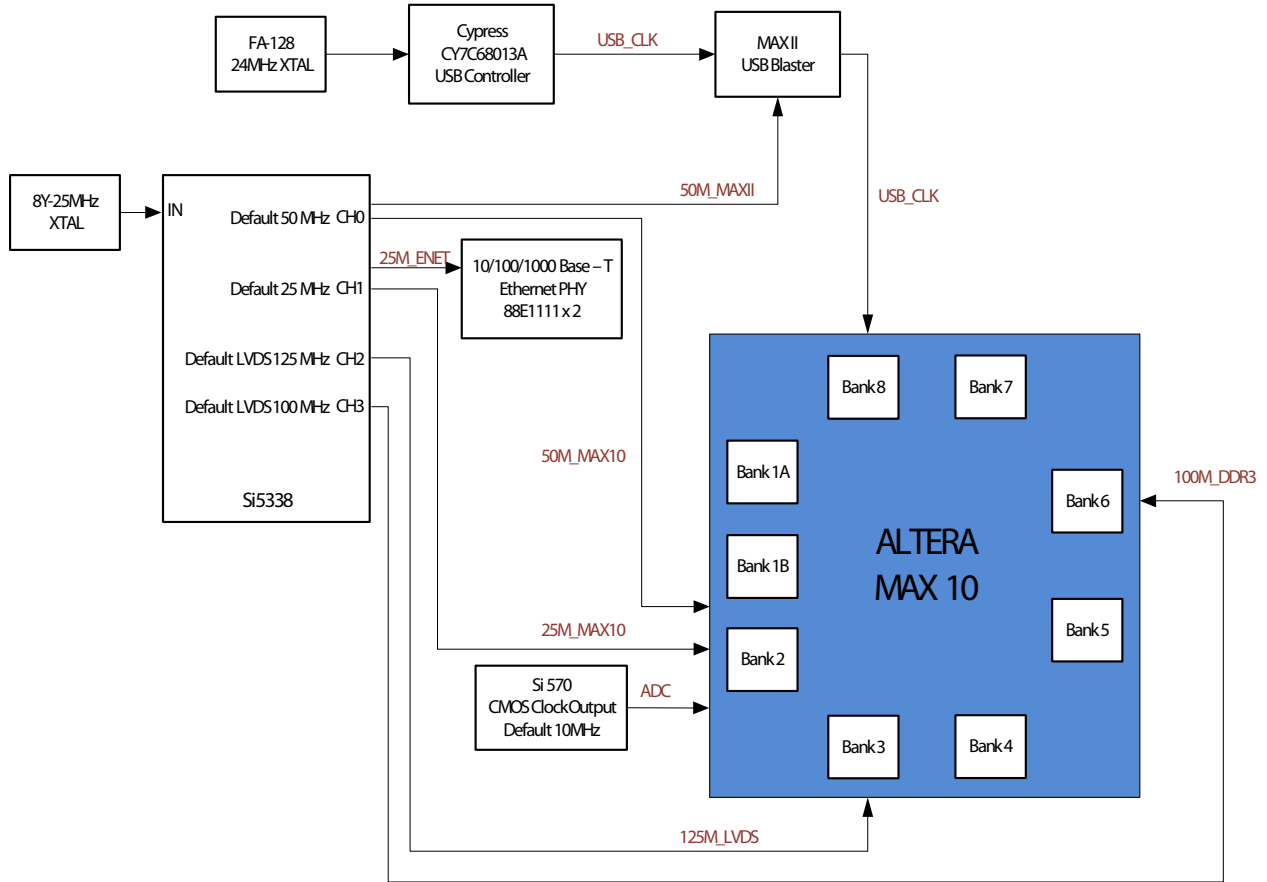

Table 4-11: On-Board Oscillators

Source	Schematic Signal Name	Frequency	I/O Standard	MAX 10 FPGA Pin Number	Application
X1	CLK_10_ADC	10.000 MHz	2.5 V CMOS	N5	Programmable default 10MHz clock for ADC
U2	CLK_25_ENET	25.000 MHz	2.5 V CMOS	-	Ethernet clock
U2	CLK_25_MAX10	25.000 MHz	2.5 V CMOS	M8	MAX 10 clock
U2	CLK_50_MAXII	25.000 MHz	2.5 V/3.3V CMOS	-	Clock for On-Board USB Blaster II
U2	CLK_50_MAX10	50.000 MHz	2.5 V CMOS	M9	MAX 10 clock

Source	Schematic Signal Name	Frequency	I/O Standard	MAX 10 FPGA Pin Number	Application
U2	CLK_DDR3_100_N	100.000 MHz	Differential SSTL-15	N15	DDR3 clocks
U2	CLK_DDR3_100_P	100.000 MHz	Differential SSTL-15	N14	DDR3 clocks
U2	CLK_LVDS_125_N	125.000 MHz	2.5 V LVDS	R11	LVDS clocks
U2	CLK_LVDS_125_P	125.000 MHz	2.5 V LVDS	P11	LVDS clocks

Note: For signal CLK_50_MAXII, the output side voltage is 2.5V and the input side voltage is 3.3V. However, they are compatible electrically.

Note: For signals CLK_DDR3_100_P and CLK_DDR3_100_N, at the MAX 10 input side, Differential SSTL-15 is used as I/O standard because this bank's VCCIO is 1.5V.

Off-Board Clock Input/Output

The development board has input and output clocks which can be driven onto the board. The output clocks can be programmed to different levels and I/O standards according to the FPGA device's specification.

Table 4-12: Off-Board Clock Inputs

Source	Schematic Signal Name	I/O Standard	MAX 10 FPGA Pin Number	Description
HSMC	HSMC_CLK_IN_N1	2.5 V	AB21	LVDS input from the installed HSMC cable or board.
HSMC	HSMC_CLK_IN_P1	2.5 V	AA20	LVDS input from the installed HSMC cable or board.
HSMC	HSMC_CLK_IN_N2	2.5 V	V9	LVDS input from the installed HSMC cable or board.
HSMC	HSMC_CLK_IN_P2	2.5 V	V10	LVDS input from the installed HSMC cable or board.
HSMC	HSMC_CLK_IN0	2.5 V	N4	Single-ended input from the installed HSMC cable or board.

Table 4-13: Off-Board Clock Outputs

Source	Schematic Signal Name	I/O Standard	MAX 10 FPGA Pin Number	Description
HSMC	HSMC_CLK_OUT_N1	2.5 V	R13	LVDS output.
HSMC	HSMC_CLK_OUT_P1	2.5 V	P13	LVDS output.
HSMC	HSMC_CLK_OUT_N2	2.5 V	V14	LVDS output.
HSMC	HSMC_CLK_OUT_P2	2.5 V	W15	LVDS output.
HSMC	HSMC_CLK_OUT0	2.5 V	AA13	FPGA CMOS output (or GPIO)

Components and Interfaces

This section describes the development board's communication ports and interface cards relative to the MAX 10 FPGA device.

10/100/1000 Ethernet PHY

The MAX 10 FPGAs development kit supports 10/100/1000 base-T Ethernet using an external Marvell 88E1111 PHY and Altera Triple-Speed Ethernet MegaCore MAC function.

Table 4-14: Ethernet PHY A Pin Assignments, Signal Names and Functions

Board Reference (U9)	Schematic Signal Name	Max 10 FPGA Pin Number	I/O Standard	Description
U9.8	ENETA_GTX_CLK	T5	2.5V CMOS	125 MHz RGMII TX clock
U9.4	ENETA_TX_CLK	E10	3.3V LVCMOS	25/2.5 MHz MII TX clock
U9.11	ENETA_TX_D0	R5	2.5V CMOS	RGMII TX data 0
U9.12	ENETA_TX_D1	P5	2.5V CMOS	RGMII TX data 1
U9.14	ENETA_TX_D2	W1	2.5V CMOS	RGMII TX data 2
U9.16	ENETA_TX_D3	W2	2.5V CMOS	RGMII TX data 3
U9.9	ENETA_TX_EN	R4	2.5V CMOS	RGMII TX enable
U9.7	ENETA_TX_ER	P4	2.5V CMOS	MII TX error
U9.2	ENETA_RX_CLK	P3	2.5V CMOS	RGMII RX clock
U9.95	ENETA_RX_D0	N9	2.5V CMOS	RGMII RX data 0
U9.92	ENETA_RX_D1	T1	2.5V CMOS	RGMII RX data 1
U9.93	ENETA_RX_D2	N1	2.5V CMOS	RGMII RX data 2
U9.91	ENETA_RX_D3	T3	2.5V CMOS	RGMII RX data 3

Board Reference (U9)	Schematic Signal Name	Max 10 FPGA Pin Number	I/O Standard	Description
U9.94	ENETA_RX_DV	T2	2.5V CMOS	RGMII RX valid
U9.3	ENETA_RX_ER	U2	2.5V CMOS	MII RX error
U9.28	ENETA_RESETN	V8	2.5V CMOS	Device reset
U9.23	ENETA_INTn	V7	2.5V CMOS	Management bus interrupt
U9.25	ENET_MDC	Y6	2.5V CMOS	MDI clock
U9.24	ENET_MDIO	Y5	2.5V CMOS	MDI data
U9.84	ENETA_RX_CR_S	N8	2.5V CMOS	MII Carrier Sense
U9.83	ENETA_RX_COL	P1	2.5V CMOS	MII Collision
U9.55	CLK_25_ENET	—	2.5V CMOS	25 MHz Reference clock
U9.70	ENETA_LED_DUPLEX	—	2.5 V CMOS	Duplex or collision LED
U9.76	ENETA_LED_LINK10	—	2.5 V CMOS	10 Mb link LED
U9.74	ENETA_LED_LINK100	R9	2.5V CMOS	100 Mb link LED
U9.73	ENETA_LED_LINK1000	—	2.5V CMOS	1000 Mb link LED
U9.58, 69	ENETA_LED_RX	—	2.5V CMOS	RX data active LED
U9.61, 68	ENETA_LED_TX	—	2.5V CMOS	TX data active LED
U9.29	ENETA_MDI_P0	—	2.5V CMOS	MDI
U9.31	ENETA_MDI_N0	—	2.5V CMOS	MDI
U9.33	ENETA_MDI_P1	—	2.5V CMOS	MDI
U9.34	ENETA_MDI_N1	—	2.5V CMOS	MDI
U9.39	ENETA_MDI_P2	—	2.5V CMOS	MDI
U9.41	ENETA_MDI_N2	—	2.5V CMOS	MDI
U9.42	ENETA_MDI_P3	—	2.5V CMOS	MDI
U9.43	ENETA_MDI_N3	—	2.5V CMOS	MDI

Table 4-15: Ethernet PHY B Pin Assignments, Signal Names and Functions

Board Reference (U10)	Schematic Signal Name	Max 10 FPGA Pin Number	I/O Standard	Description
U10.8	ENETB_GTX_CLK	T6	2.5V CMOS	125 MHz RGMII TX clock
U10.4	ENETB_TX_CLK	E11	3.3V LVCMOS	25/2.5 MHz MII TX clock
U10.11	ENETB_TX_D0	U1	2.5V CMOS	RGMII TX data 0
U10.12	ENETB_TX_D1	V1	2.5V CMOS	RGMII TX data 1
U10.14	ENETB_TX_D2	U3	2.5V CMOS	RGMII TX data 2
U10.16	ENETB_TX_D3	U4	2.5V CMOS	RGMII TX data 3
U10.9	ENETB_TX_EN	V3	2.5V CMOS	RGMII TX enable
U10.7	ENETB_TX_ER	U5	2.5V CMOS	MII TX error
U10.2	ENETB_RX_CLK	R3	2.5V CMOS	RGMII RX clock
U10.95	ENETB_RX_D0	P8	2.5V CMOS	RGMII RX data 0
U10.92	ENETB_RX_D1	M1	2.5V CMOS	RGMII RX data 1
U10.93	ENETB_RX_D2	M2	2.5V CMOS	RGMII RX data 2
U10.91	ENETB_RX_D3	R7	2.5V CMOS	RGMII RX data 3
U10.94	ENETB_RX_DV	R1	2.5V CMOS	RGMII RX valid
U10.3	ENETB_RX_ER	R2	2.5V CMOS	MII RX error
U10.28	ENETB_RESETh	AB4	2.5V CMOS	Device reset
U10.23	ENETB_INTn	AA3	2.5V CMOS	Management bus interrupt
U10.25	ENET_MDC	Y6	2.5V CMOS	MDI clock
U10.24	ENET_MDIO	Y5	2.5V CMOS	MDI data
U10.84	ENETB_RX_CRD	N3	2.5V CMOS	MII Carrier Sense
U10.83	ENETB_RX_COL	N2	2.5V CMOS	MII Collision
U10.55	CLK_25_ENET	—	2.5V CMOS	25 MHz Reference clock
U10.70	ENETB_LED_DUPLEX	—	2.5V CMOS	Duplex or collision LED
U10.76	ENETB_LED_LINK10	—	2.5V CMOS	10 Mb link LED
U10.74	ENETB_LED_LINK100	P9	2.5V CMOS	100 Mb link LED

Board Reference (U10)	Schematic Signal Name	Max 10 FPGA Pin Number	I/O Standard	Description
U10.73	ENETB_LED_LINK1000	—	2.5V CMOS	1000 Mb link LED
U10.58, 69	ENETB_LED_RX	—	2.5V CMOS	RX data active LED
U10.61, 65, 68	ENETB_LED_TX	—	2.5V CMOS	TX data active LED
U10.29	ENETB_MDI_P0	—	2.5V CMOS	MDI
U10.31	ENETB_MDI_N0	—	2.5V CMOS	MDI
U10.33	ENETB_MDI_P1	—	2.5V CMOS	MDI
U10.34	ENETB_MDI_N1	—	2.5V CMOS	MDI
U10.39	ENETB_MDI_P2	—	2.5V CMOS	MDI
U10.41	ENETB_MDI_N2	—	2.5V CMOS	MDI
U10.42	ENETB_MDI_P3	—	2.5V CMOS	MDI
U10.43	ENETB_MDI_N3	—	2.5V CMOS	MDI

Digital-to-Analog Converter

The MAX 10 FPGA comes with one external 16-bit digital-to-analog converter (DAC) device with an SMA output.

The MAX 10 FPGA has two 12-bit successive approximation register (SAR) ADCs with a sample rate of 1 MSps. One potentiometer is connected to ADC1_CH6 to function as a user-controlled DC, and it is connected to 2.5 V. To ensure performance evaluation of the ADCs, the MAX 10 development kit has separate analog supply and split partition for analog ground. An external 16-bit single channel DAC is connected to Bank 7 to enable closed loop evaluation. The DAC uses a 3-wire serial interface that operates at clock rates up to 30 MHz. It is compatible with standard serial peripheral interface (SPI), quad SPI, Microwire, and digital signal processor (DSP) interfaces.

Table 4-16: Digital-to-Analog Converter Signals

Board Reference (U33)	Signal Name	MAX 10 FPGA Pin Number	I/O Standard	Description
U33.5	DAC_SYNC	U1.B10	3.3 V	Level-triggered control input (active LOW). Frame synchronization signal for the input data.
U33.6	DAC_SCLK	A7	3.3 V	Serial clock input
U33.7	DAC_DIN	A8	3.3 V	Serial data input

HDMI Video Output

The MAX 10 FPGA development kit supports one HDMI transmitter and one HDMI receptacle.

The transmitter incorporates HDMI v1.4 features, and is capable of supporting an input data rate up to 165 MHz (1080p @60Hz, UXGA @60Hz). The connection between HDMI transmitter and MAX 10 is established in Bank 7, and the communication can be done via I²C interface.

Table 4-17: HDMI Pin Assignments, Signal Names and Functions

Board Reference (U8)	Schematic Signal Name	Max 10 FPGA Pin Number	I/O Standard	Description
U8.62	HDMI_TX_D0	A17	3.3 V	HDMI digital video data bus
U8.61	HDMI_TX_D1	A18	3.3 V	HDMI digital video data bus
U8.60	HDMI_TX_D2	A12	3.3 V	HDMI digital video data bus
U8.59	HDMI_TX_D3	F16	3.3 V	HDMI digital video data bus
U8.58	HDMI_TX_D4	A16	3.3 V	HDMI digital video data bus
U8.57	HDMI_TX_D5	B12	3.3 V	HDMI digital video data bus
U8.56	HDMI_TX_D6	F15	3.3 V	HDMI digital video data bus
U8.55	HDMI_TX_D7	B11	3.3 V	HDMI digital video data bus
U8.54	HDMI_TX_D8	A13	3.3 V	HDMI digital video data bus
U8.52	HDMI_TX_D9	C15	3.3 V	HDMI digital video data bus
U8.50	HDMI_TX_D10	C11	3.3 V	HDMI digital video data bus
U8.49	HDMI_TX_D11	A11	3.3 V	HDMI digital video data bus
U8.48	HDMI_TX_D12	A20	3.3 V	HDMI digital video data bus
U8.47	HDMI_TX_D13	H13	3.3 V	HDMI digital video data bus
U8.46	HDMI_TX_D14	E14	3.3 V	HDMI digital video data bus

Board Reference (U8)	Schematic Signal Name	Max 10 FPGA Pin Number	I/O Standard	Description
U8.45	HDMI_TX_D15	D12	3.3 V	HDMI digital video data bus
U8.44	HDMI_TX_D16	C12	3.3 V	HDMI digital video data bus
U8.43	HDMI_TX_D17	C19	3.3 V	HDMI digital video data bus
U8.42	HDMI_TX_D18	C18	3.3 V	HDMI digital video data bus
U8.41	HDMI_TX_D19	B19	3.3 V	HDMI digital video data bus
U8.40	HDMI_TX_D20	B17	3.3 V	HDMI digital video data bus
U8.39	HDMI_TX_D21	B16	3.3 V	HDMI digital video data bus
U8.38	HDMI_TX_D22	C16	3.3 V	HDMI digital video data bus
U8.37	HDMI_TX_D23	A15	3.3 V	HDMI digital video data bus
U8.53	HDMI_TX_CLK	D6	3.3 V	Video clock
U8.63	HDMI_TX_DE	C10	3.3 V	Video data enable
U8.64	HDMI_TX_HS	A19	3.3 V	Vertical Synchronization
U8.2	HDMI_TX_VS	J12	3.3 V	Horizontal Synchronization
U8.28	HDMI_TX_INT	D15	3.3 V	Interrupt Signal
U8.35	HDMI_SCL	A10	3.3 V	HDMI I2C clock
U8.36	HDMI_SDA	B15	3.3 V	HDMI I2C data

HSMC

The high-speed mezzanine card (HSMC) interface is based on the Samtec 0.5 mm pitch, surface-mount QTH/QSH family of connectors. It is designed to support a full SPI-4.2 interface (17 LVDS channels) and 3 input and output clocks as well as SMBus and JTAG signals.

Since MAX 10 does not have transceiver channels, the HSMC clock-data-recovery channels are left unconnected.

The HSMC interface has programmable bi-directional I/O pins that can be used as 2.5-V LVCMOS, which is 3.3-V LVTTTL-compatible. These pins can also be used as various differential I/O standards including, but not limited to, LVDS, mini-LVDS, and RSDS with up to 17 full-duplex channels.

As noted in the *High Speed Mezzanine Card (HSMC) Specification manual*, LVDS and single-ended I/O standards are only guaranteed to function when mixed according to either the generic single-ended pin-out or generic differential pin-out.

For more information about the HSMC specification such as signaling standards, signal integrity, compatible connectors, and mechanical information, refer to the *High Speed Mezzanine Card (HSMC) Specification manual*.

Table 4-18: HSMC Schematic Signals

Board Reference (J2)	Schematic Signal Name	MAX 10 / MAX II Pin Number	I/O Standard	Description
33	HSMC_SDA	AA19	2.5V CMOS inout	Management serial data line
34	HSMC_SCL	Y18	2.5V CMOS out	Management serial clock line
35	HSMC_JTAG_TCK	A9 (MAX II)	part of chain	JTAG clock
36	HSMC_JTAG_TMS	A8 (MAX II)	part of chain	JTAG mode select
37	HSMC_JTAG_TDO	A7 (MAX II)	part of chain	JTAG data out
38	HSMC_JTAG_TDI	A6 (MAX II)	part of chain	JTAG data in
39	HSMC_CLK_OUT0	AA13	2.5V CMOS clock output	clock output 0
40	HSMC_CLK_IN0	N4	2.5V CMOS clock in	Clock input 0
41	HSMC_D0	Y7	2.5v CMOS inout	Data bus
42	HSMC_D1	Y8	2.5v CMOS inout	Data bus
43	HSMC_D2	AB2	2.5v CMOS inout	Data bus
44	HSMC_D3	AB3	2.5v CMOS inout	Data bus
47	HSMC_TX_D_P0	W3	2.5v CMOS inout or LVDS TX channels-p	Data bus
48	HSMC_RX_D_P0	V5	2.5V CMOS inout or LVDS RX channels-p	Data bus
49	HSMC_TX_D_N0	W4	2.5V CMOS inout or LVDS TX channels-n	Data bus
50	HSMC_RX_D_N0 ⁽¹⁾	V4	2.5V CMOS inout or LVDS RX channels-n	Data bus
53	HSMC_TX_D_P1	U7	2.5v CMOS inout or LVDS TX channels-p	Data bus
54	HSMC_RX_D_P1 ⁽¹⁾	Y2	2.5V CMOS inout or LVDS RX channels-p	Data bus

⁽¹⁾ MAX 10 doesn't have internal termination for LVDS RX. Install a 100-ohm resistor to support LVDS RX on HSMC.

Board Reference (J2)	Schematic Signal Name	MAX 10 / MAX II Pin Number	I/O Standard	Description
55	HSMC_TX_D_N1	U6	2.5V CMOS inout or LVDS TX channels-n	Data bus
56	HSMC_RX_D_N1 ⁽¹⁾	Y1	2.5V CMOS inout or LVDS RX channels-n	Data bus
59	HSMC_TX_D_P2	W6	2.5v CMOS inout or LVDS TX channels-p	Data bus
60	HSMC_RX_D_P2 ⁽¹⁾	AA20	2.5V CMOS inout or LVDS RX channels-p	Data bus
61	HSMC_TX_D_N2	W5	2.5V CMOS inout or LVDS TX channels-n	Data bus
62	HSMC_RX_D_N2 ⁽¹⁾	AA1	2.5V CMOS inout or LVDS RX channels-n	Data bus
65	HSMC_TX_D_P3	W8	2.5v CMOS inout or LVDS TX channels-p	Data bus
66	HSMC_RX_D_P3 ⁽¹⁾	AB8	2.5V CMOS inout or LVDS RX channels-p	Data bus
67	HSMC_TX_D_N3	W7	2.5V CMOS inout or LVDS TX channels-n	Data bus
68	HSMC_RX_D_N3 ⁽¹⁾	AA8	2.5V CMOS inout or LVDS RX channels-n	Data bus
71	HSMC_TX_D_P4	AA10	2.5v CMOS inout or LVDS TX channels-p	Data bus
72	HSMC_RX_D_P4 ⁽¹⁾	AB9	2.5V CMOS inout or LVDS RX channels-p	Data bus
73	HSMC_TX_D_N4	Y10	2.5V CMOS inout or LVDS TX channels-n	Data bus
74	HSMC_RX_D_N4 ⁽¹⁾	AA9	2.5V CMOS inout or LVDS RX channels-n	Data bus
77	HSMC_TX_D_P5	AA7	2.5v CMOS inout or LVDS TX channels-p	Data bus
78	HSMC_RX_D_P5 ⁽¹⁾	AB7	2.5V CMOS inout or LVDS RX channels-p	Data bus
79	HSMC_TX_D_N5	AA6	2.5V CMOS inout or LVDS TX channels-n	Data bus
80	HSMC_RX_D_N5 ⁽¹⁾	AB6	2.5V CMOS inout or LVDS RX channels-n	Data bus
83	HSMC_TX_D_P6	P10	2.5v CMOS inout or LVDS TX channels-p	Data bus
84	HSMC_RX_D_P6 ⁽¹⁾	Y4	2.5V CMOS inout or LVDS RX channels-p	Data bus

Board Reference (J2)	Schematic Signal Name	MAX 10 / MAX II Pin Number	I/O Standard	Description
85	HSMC_TX_D_N6	R10	2.5V CMOS inout or LVDS TX channels-n	Data bus
86	HSMC_RX_D_N6 ⁽¹⁾	Y3	2.5V CMOS inout or LVDS RX channels-n	Data bus
89	HSMC_TX_D_P7	W10	2.5v CMOS inout or LVDS TX channels-p	Data bus
90	HSMC_RX_D_P7 ⁽¹⁾	AB5	2.5V CMOS inout or LVDS RX channels-p	Data bus
91	HSMC_TX_D_N7	W9	2.5V CMOS inout or LVDS TX channels-n	Data bus
92	HSMC_RX_D_N7 ⁽¹⁾	AA5	2.5V CMOS inout or LVDS RX channels-n	Data bus
95	HSMC_CLK_OUT_P1	P13	2.5V CMOS inout or LVDS clock out	Clock output 1
96	HSMC_CLK_IN_P1	AA20	2.5V CMOS inout or LVDS clock in	Clock input 1
97	HSMC_CLK_OUT_N1	R13	2.5V CMOS inout or LVDS clock out	Clock output 1
98	HSMC_CLK_IN_N1	AB21	2.5V CMOS inout or LVDS clock in	Clock input 1
101	HSMC_TX_D_P8	W14	2.5v CMOS inout or LVDS TX channels-p	Data bus
102	HSMC_RX_D_P8 ⁽¹⁾	W13	2.5V CMOS inout or LVDS RX channels-p	Data bus
103	HSMC_TX_D_N8	V13	2.5V CMOS inout or LVDS TX channels-n	Data bus
104	HSMC_RX_D_N8 ⁽¹⁾	W12	2.5V CMOS inout or LVDS RX channels-n	Data bus
107	HSMC_TX_D_P9	Y14	2.5v CMOS inout or LVDS TX channels-p	Data bus
108	HSMC_RX_D_P9 ⁽¹⁾	AB15	2.5V CMOS inout or LVDS RX channels-p	Data bus
109	HSMC_TX_D_N9	Y13	2.5V CMOS inout or LVDS TX channels-n	Data bus
110	HSMC_RX_D_N9 ⁽¹⁾	AA14	2.5V CMOS inout or LVDS RX channels-n	Data bus
113	HSMC_TX_D_P10	V16	2.5v CMOS inout or LVDS TX channels-p	Data bus
114	HSMC_RX_D_P10 ⁽¹⁾	Y16	2.5V CMOS inout or LVDS RX channels-p	Data bus

Board Reference (J2)	Schematic Signal Name	MAX 10 / MAX II Pin Number	I/O Standard	Description
115	HSMC_TX_D_N10	U15	2.5V CMOS inout or LVDS TX channels-n	Data bus
116	HSMC_RX_D_N10 ⁽¹⁾	AA15	2.5V CMOS inout or LVDS RX channels-n	Data bus
119	HSMC_TX_D_P11	W16	2.5v CMOS inout or LVDS TX channels-p	Data bus
120	HSMC_RX_D_P11 ⁽¹⁾	AA16	2.5V CMOS inout or LVDS RX channels-p	Data bus
121	HSMC_TX_D_N11	V15	2.5V CMOS inout or LVDS TX channels-n	Data bus
122	HSMC_RX_D_N11 ⁽¹⁾	AB16	2.5V CMOS inout or LVDS RX channels-n	Data bus
125	HSMC_TX_D_P12	V17	2.5v CMOS inout or LVDS TX channels-p	Data bus
126	HSMC_RX_D_P12 ⁽¹⁾	AB18	2.5V CMOS inout or LVDS RX channels-p	Data bus
127	HSMC_TX_D_N12	W17	2.5V CMOS inout or LVDS TX channels-n	Data bus
128	HSMC_RX_D_N12 ⁽¹⁾	AB17	2.5V CMOS inout or LVDS RX channels-n	Data bus
131	HSMC_TX_D_P13	V12	2.5v CMOS inout or LVDS TX channels-p	Data bus
132	HSMC_RX_D_P13 ⁽¹⁾	Y11	2.5V CMOS inout or LVDS RX channels-p	Data bus
133	HSMC_TX_D_N13	V11	2.5V CMOS inout or LVDS TX channels-n	Data bus
134	HSMC_RX_D_N13 ⁽¹⁾	W11	2.5V CMOS inout or LVDS RX channels-n	Data bus
137	HSMC_TX_D_P14	P12	2.5v CMOS inout or LVDS TX channels-p	Data bus
138	HSMC_RX_D_P14 ⁽¹⁾	AB11	2.5V CMOS inout or LVDS RX channels-p	Data bus
139	HSMC_TX_D_N14	R12	2.5V CMOS inout or LVDS TX channels-n	Data bus
140	HSMC_RX_D_N14 ⁽¹⁾	AB10	2.5V CMOS inout or LVDS RX channels-n	Data bus
143	HSMC_TX_D_P15	AA12	2.5v CMOS inout or LVDS TX channels-p	Data bus
144	HSMC_RX_D_P15 ⁽¹⁾	AB13	2.5V CMOS inout or LVDS RX channels-p	Data bus

Board Reference (J2)	Schematic Signal Name	MAX 10 / MAX II Pin Number	I/O Standard	Description
145	HSMC_TX_D_N15	AA11	2.5V CMOS inout or LVDS TX channels-n	Data bus
146	HSMC_RX_D_N15 ⁽¹⁾	AB12	2.5V CMOS inout or LVDS RX channels-n	Data bus
149	HSMC_TX_D_P16	Y17	2.5v CMOS inout or LVDS TX channels-p	Data bus
150	HSMC_RX_D_P16 ⁽¹⁾	AB20	2.5V CMOS inout or LVDS RX channels-p	Data bus
151	HSMC_TX_D_N16	AA17	2.5V CMOS inout or LVDS TX channels-n	Data bus
152	HSMC_RX_D_N16 ⁽¹⁾	AB19	2.5V CMOS inout or LVDS RX channels-n	Data bus
155	HSMC_CLK_OUT_P2	W15	2.5V CMOS inout or LVDS clock out	Clock output 2
156	HSMC_CLK_IN_P2	V10	2.5V CMOS inout or LVDS clock in	Clock input 2
157	HSMC_CLK_OUT_N2	V14	2.5V CMOS inout or LVDS clock out	Clock output 2
158	HSMC_CLK_IN_N2	V9	2.5V CMOS inout or LVDS clock in	Clock input 2
160	HSMC_PRSNTh	AB14	2.5V	Present

Related Information

[High Speed Mezzanine Card \(HSMC\) Specification](#)

Pmod Connectors

The MAX 10 FPGA development kit features two Digilent Pmod™ compatible headers, which are used to connect low frequency, low I/O pin count peripheral modules.

The 12-pin version Pmod connector used in this kit provides 8 I/O signal pins. The peripheral module interface also encompasses a variant using I²C interface, and two or four wire MTE cables. The Pmod signals are connected to Bank 8.

Table 4-19: Pmod A Pin Assignments, Signal Names and Functions

Schematic Signal Name	Schematic Share Bus Signal Name	MAX 10 FPGA Pin Number	I/O Standard	Description
PMODA_D0	PMODA_IO0	C7	3.3V	In/Out
PMODA_D1	PMODA_IO1	C8	3.3V	In/Out
PMODA_D2	PMODA_IO2	A6	3.3V	In/Out
PMODA_D3	PMODA_IO3	B7	3.3V	In/Out

Schematic Signal Name	Schematic Share Bus Signal Name	MAX 10 FPGA Pin Number	I/O Standard	Description
PMODA_D4	PMODA_IO4	D8	3.3V	In/Out
PMODA_D5	PMODA_IO5	A4	3.3V	In/Out
PMODA_D6	PMODA_IO6	A5	3.3V	In/Out
PMODA_D7	PMODA_IO7	E9	3.3V	In/Out
—	VCC	—	3.3V	Power
—	GND	—	—	GND

Table 4-20: Pmod B Pin Assignments, Signal Names and Functions

Schematic Signal Name	Schematic Share Bus Signal Name	MAX 10 FPGA Pin Number	I/O Standard	Description
PMODB_D0	PMODB_IO0	E8	3.3V	In/Out
PMODB_D1	PMODB_IO1	D5	3.3V	In/Out
PMODB_D2	PMODB_IO2	B5	3.3V	In/Out
PMODB_D3	PMODB_IO3	C4	3.3V	In/Out
PMODB_D4	PMODB_IO4	A2	3.3V	In/Out
PMODB_D5	PMODB_IO5	A3	3.3V	In/Out
PMODB_D6	PMODB_IO6	B4	3.3V	In/Out
PMODB_D7	PMODB_IO7	B3	3.3V	In/Out
—	VCC	—	3.3V	Power
—	GND	—	—	GND

USB to UART

The board uses a USB based UART bridge chip (FT232R) to bridge communication to a host for general software debug for Nios and non-Nios systems. This chip uses TXD and RXD for transmission and reception of data. A mini B plug receptacle is used to minimize board space. The related I/O utilization is implemented in Bank 4.

Table 4-21: USB-UART Pin Assignments, Signal Names and Functions

Board Reference (U11)	Schematic Signal Name	MAX 10 FPGA Pin Number	I/O Standard	Description
U11.2	UART_TX	W18	2.5 V	Transmit asynchronous data output

Board Reference (U11)	Schematic Signal Name	MAX 10 FPGA Pin Number	I/O Standard	Description
U11.30	UART_RX	Y19	2.5 V	Receive asynchronous data input

Memory

This section describes the development board's memory interface support and also their signal names, types, and connectivity relative to the FPGA.

DDR3 Rev. B Board

Note: For your board's revision, look for the board serial number on the back of the board at the bottom. Refer to the *General Description* section for an image of the back board.

The MAX 10 FPGA provides full-speed support to a x16 DDR3 300-MHz interface by using a 1 Gbit x16 memory. Additionally, the MAX 10 supports the error correction code (ECC) feature.

Caution: The DDR3 address signals at F18, E19, F20 and F21 on rev. B boards violate MAX 10 external memory guidelines when implementing DDR3 on the 10M50 F484 device. Altera recommends you follow the MAX 10 guidelines for your own board designs and utilize Quartus II software to verify pin location compliance. Contact Altera support if you received DDR3 pin location errors for your Rev. B kit designs.

Table 4-22: DDR3 Pin Assignments, Signal Names, and Functions

Board Reference (U5 & U6)	Schematic Signal Name	MAX 10 FPGA Pin Number	I/O Standard	Description
U5.N3 - U6.K3	DDR3_A0	V20	1.5V SSTL	Address bus
U5.P7 - U6.L7	DDR3_A1	F20	1.5V SSTL	Address bus Refer to Caution statement above.
U5.P3 - U6.L3	DDR3_A2	F18	1.5V SSTL	Address bus Refer to Caution statement above.
U5.N2 - U6.K2	DDR3_A3	U20	1.5V SSTL	Address bus
U5.P8 - U6.L8	DDR3_A4	F21	1.5V SSTL	Address bus Refer to Caution statement above.
U5.P2 - U6.L2	DDR3_A5	F19	1.5V SSTL	Address bus
U5.R8 - U6.M8	DDR3_A6	E21	1.5V SSTL	Address bus

Board Reference (U5 & U6)	Schematic Signal Name	MAX 10 FPGA Pin Number	I/O Standard	Description
U5.R2 - U6.M2	DDR3_A7	E19	1.5V SSTL	Address bus Refer to Caution statement above.
U5.T8 - U6.N8	DDR3_A8	D22	1.5V SSTL	Address bus
U5.R3 - U6.M3	DDR3_A9	E22	1.5V SSTL	Address bus
U5.L7 - U6.H7	DDR3_A10	Y20	1.5V SSTL	Address bus
U5.R7 - U6.M7	DDR3_A11	E20	1.5V SSTL	Address bus
U5.N7 - U6.K7	DDR3_A12	J14	1.5V SSTL	Address bus
U5.T3 - U6.N3	DDR3_A13	C22	1.5V SSTL	Address bus
U5.M2 - U6.J2	DDR3_BA0	V22	1.5V SSTL	Bank address bus
U5.N8 - U6.K8	DDR3_BA1	N18	1.5V SSTL	Bank address bus
U5.M3 - U6.J3	DDR3_BA2	W22	1.5V SSTL	Bank address bus
U5.K3 - U6.G3	DDR3_CASn	U19	1.5V SSTL	Row address bus
U5.K9 - U6.G9	DDR3_CKE	W20	1.5V SSTL	Clock enable
U5.J7 - U6.F7	DDR3_CLK_P	D18	Differential 1.5V SSTL	Differential output clock
U5.K7 - U6.G7	DDR3_CLK_N	E18	Differential 1.5V SSTL	Differential output clock
U5.L2 - U6.H2	DDR3_CSn	Y22	1.5V SSTL	Chip select
U5.E7	DDR3_DM0	J15	1.5V SSTL	Write mask byte lane 0
U5.D3	DDR3_DM1	N19	1.5V SSTL	Write mask byte lane 1
U6.B7	DDR3_DM2	T18	1.5V SSTL	Write mask byte lane 2
U5.E3	DDR3_DQ0	J18	1.5V SSTL	Data bus byte lane 0
U5.F7	DDR3_DQ1	K20	1.5V SSTL	Data bus byte lane 0
U5.F2	DDR3_DQ2	H18	1.5V SSTL	Data bus byte lane 0
U5.F8	DDR3_DQ3	K18	1.5V SSTL	Data bus byte lane 0
U5.H3	DDR3_DQ4	H19	1.5V SSTL	Data bus byte lane 0
U5.H8	DDR3_DQ5	J20	1.5V SSTL	Data bus byte lane 0
U5.G2	DDR3_DQ6	H20	1.5V SSTL	Data bus byte lane 0
U5.H7	DDR3_DQ7	K19	1.5V SSTL	Data bus byte lane 0
U5.D7	DDR3_DQ8	L20	1.5V SSTL	Data bus byte lane 1
U5.C3	DDR3_DQ9	M18	1.5V SSTL	Data bus byte lane 1
U5.C8	DDR3_DQ10	M20	1.5V SSTL	Data bus byte lane 1
U5.C2	DDR3_DQ11	M14	1.5V SSTL	Data bus byte lane 1

Board Reference (U5 & U6)	Schematic Signal Name	MAX 10 FPGA Pin Number	I/O Standard	Description
U5.A7	DDR3_DQ12	L18	1.5V SSTL	Data bus byte lane 1
U5.A2	DDR3_DQ13	M15	1.5V SSTL	Data bus byte lane 1
U5.B8	DDR3_DQ14	L19	1.5V SSTL	Data bus byte lane 1
U5.A3	DDR3_DQ15	N20	1.5V SSTL	Data bus byte lane 1
U6.B3	DDR3_DQ16	R14	1.5V SSTL	Data bus byte lane 2
U6.C7	DDR3_DQ17	P19	1.5V SSTL	Data bus byte lane 2
U6.C2	DDR3_DQ18	P14	1.5V SSTL	Data bus byte lane 2
U6.C8	DDR3_DQ19	R20	1.5V SSTL	Data bus byte lane 2
U6.E3	DDR3_DQ20	R15	1.5V SSTL	Data bus byte lane 2
U6.E8	DDR3_DQ21	T19	1.5V SSTL	Data bus byte lane 2
U6.D2	DDR3_DQ22	P15	1.5V SSTL	Data bus byte lane 2
U6.E7	DDR3_DQ23	P20	1.5V SSTL	Data bus byte lane 2
U5.F3	DDR3_DQS_P0	K14	Differential 1.5V SSTL	Data strobe P byte lane 0
U5.G3	DDR3_DQS_N0	K15	Differential 1.5V SSTL	Data strobe N byte lane 0
U5.C7	DDR3_DQS_P1	L14	Differential 1.5V SSTL	Data strobe P byte lane 1
U5.B7	DDR3_DQS_N1	L15	Differential 1.5V SSTL	Data strobe N byte lane 1
U6.C3	DDR3_DQS_P2	R18	Differential 1.5V SSTL	Data strobe P byte lane 2
U6.D3	DDR3_DQS_N2	P18	Differential 1.5V SSTL	Data strobe N byte lane 2
U5.K1 - U6.G1	DDR3_ODT	W19	1.5V SSTL	On-die termination enable
U5.J3 - U6.F3	DDR3_RASn	V18	1.5V SSTL	Row address select
U5.T2 - U6.N2	DDR3_RESETh	B22	1.5V SSTL	Reset
U5.L3 - U6.H3	DDR3_WEn	Y21	1.5V SSTL	Write enable
U5.L8	DDR3_ZQ1	—	1.5V SSTL	ZQ impedance calibration
U6.H8	DDR3_ZQ2	—	1.5V SSTL	ZQ impedance calibration

Related Information

[General Description](#) on page 1-2

DDR3 Rev. C Board

Note: For your board's revision, look for the board serial number on the back the board at the bottom.

The MAX 10 FPGA provides full-speed support to a x16 DDR3 300-MHz interface by using a 1 Gbit x16 memory. Additionally, the MAX 10 supports the error correction code (ECC) feature.

Table 4-23: DDR3 Pin Assignments, Signal Names, and Functions

Board Reference (U5 & U6)	Schematic Signal Name	MAX 10 FPGA Pin Number	I/O Standard	Description
U5.N3 - U6.K3	DDR3_A0	V20	1.5V SSTL	Address bus
U5.P7 - U6.L7	DDR3_A1	D19	1.5V SSTL	Address bus
U5.P3 - U6.L3	DDR3_A2	A21	1.5V SSTL	Address bus
U5.N2 - U6.K2	DDR3_A3	U20	1.5V SSTL	Address bus
U5.P8 - U6.L8	DDR3_A4	C20	1.5V SSTL	Address bus
U5.P2 - U6.L2	DDR3_A5	F19	1.5V SSTL	Address bus
U5.R8 - U6.M8	DDR3_A6	E21	1.5V SSTL	Address bus
U5.R2 - U6.M2	DDR3_A7	B20	1.5V SSTL	Address bus
U5.T8 - U6.N8	DDR3_A8	D22	1.5V SSTL	Address bus
U5.R3 - U6.M3	DDR3_A9	E22	1.5V SSTL	Address bus
U5.L7 - U6.H7	DDR3_A10	Y20	1.5V SSTL	Address bus
U5.R7 - U6.M7	DDR3_A11	E20	1.5V SSTL	Address bus
U5.N7 - U6.K7	DDR3_A12	J14	1.5V SSTL	Address bus
U5.T3 - U6.N3	DDR3_A13	C22	1.5V SSTL	Address bus
U5.M2 - U6.J2	DDR3_BA0	V22	1.5V SSTL	Bank address bus
U5.N8 - U6.K8	DDR3_BA1	N18	1.5V SSTL	Bank address bus
U5.M3 - U6.J3	DDR3_BA2	W22	1.5V SSTL	Bank address bus
U5.K3 - U6.G3	DDR3_CASn	U19	1.5V SSTL	Row address bus
U5.K9 - U6.G9	DDR3_CKE	W20	1.5V SSTL	Clock enable
U5.J7 - U6.F7	DDR3_CLK_P	D18	Differential 1.5V SSTL	Differential output clock
U5.K7 - U6.G7	DDR3_CLK_N	E18	Differential 1.5V SSTL	Differential output clock
U5.L2 - U6.H2	DDR3_CSn	Y22	1.5V SSTL	Chip select
U5.E7	DDR3_DM0	J15	1.5V SSTL	Write mask byte lane 0
U5.D3	DDR3_DM1	N19	1.5V SSTL	Write mask byte lane 1
U6.B7	DDR3_DM2	T18	1.5V SSTL	Write mask byte lane 2
U5.E3	DDR3_DQ0	J18	1.5V SSTL	Data bus byte lane 0
U5.F7	DDR3_DQ1	K20	1.5V SSTL	Data bus byte lane 0
U5.F2	DDR3_DQ2	H18	1.5V SSTL	Data bus byte lane 0

Board Reference (U5 & U6)	Schematic Signal Name	MAX 10 FPGA Pin Number	I/O Standard	Description
U5.F8	DDR3_DQ3	K18	1.5V SSTL	Data bus byte lane 0
U5.H3	DDR3_DQ4	H19	1.5V SSTL	Data bus byte lane 0
U5.H8	DDR3_DQ5	J20	1.5V SSTL	Data bus byte lane 0
U5.G2	DDR3_DQ6	H20	1.5V SSTL	Data bus byte lane 0
U5.H7	DDR3_DQ7	K19	1.5V SSTL	Data bus byte lane 0
U5.D7	DDR3_DQ8	L20	1.5V SSTL	Data bus byte lane 1
U5.C3	DDR3_DQ9	M18	1.5V SSTL	Data bus byte lane 1
U5.C8	DDR3_DQ10	M20	1.5V SSTL	Data bus byte lane 1
U5.C2	DDR3_DQ11	M14	1.5V SSTL	Data bus byte lane 1
U5.A7	DDR3_DQ12	L18	1.5V SSTL	Data bus byte lane 1
U5.A2	DDR3_DQ13	M15	1.5V SSTL	Data bus byte lane 1
U5.B8	DDR3_DQ14	L19	1.5V SSTL	Data bus byte lane 1
U5.A3	DDR3_DQ15	N20	1.5V SSTL	Data bus byte lane 1
U6.B3	DDR3_DQ16	R14	1.5V SSTL	Data bus byte lane 2
U6.C7	DDR3_DQ17	P19	1.5V SSTL	Data bus byte lane 2
U6.C2	DDR3_DQ18	P14	1.5V SSTL	Data bus byte lane 2
U6.C8	DDR3_DQ19	R20	1.5V SSTL	Data bus byte lane 2
U6.E3	DDR3_DQ20	R15	1.5V SSTL	Data bus byte lane 2
U6.E8	DDR3_DQ21	T19	1.5V SSTL	Data bus byte lane 2
U6.D2	DDR3_DQ22	P15	1.5V SSTL	Data bus byte lane 2
U6.E7	DDR3_DQ23	P20	1.5V SSTL	Data bus byte lane 2
U5.F3	DDR3_DQS_P0	K14	Differential 1.5V SSTL	Data strobe P byte lane 0
U5.G3	DDR3_DQS_N0	K15	Differential 1.5V SSTL	Data strobe N byte lane 0
U5.C7	DDR3_DQS_P1	L14	Differential 1.5V SSTL	Data strobe P byte lane 1
U5.B7	DDR3_DQS_N1	L15	Differential 1.5V SSTL	Data strobe N byte lane 1
U6.C3	DDR3_DQS_P2	R18	Differential 1.5V SSTL	Data strobe P byte lane 2
U6.D3	DDR3_DQS_N2	P18	Differential 1.5V SSTL	Data strobe N byte lane 2
U5.K1 - U6.G1	DDR3_ODT	W19	1.5V SSTL	On-die termination enable
U5.J3 - U6.F3	DDR3_RASn	V18	1.5V SSTL	Row address select

Board Reference (U5 & U6)	Schematic Signal Name	MAX 10 FPGA Pin Number	I/O Standard	Description
U5.T2 - U6.N2	DDR3_RESETh	B22	1.5V SSTL	Reset
U5.L3 - U6.H3	DDR3_WEn	Y21	1.5V SSTL	Write enable
U5.L8	DDR3_ZQ1	—	1.5V SSTL	ZQ impedance calibration
U6.H8	DDR3_ZQ2	—	1.5V SSTL	ZQ impedance calibration

Flash

The MAX 10 FPGA development kit provides a 512-Mb (megabit) quad SPI flash memory. Altera Generic QUAD SPI controller core is used by default to erase, read, and write quad SPI flash in reference designs of the Board Test System (BTS) installer.

If you use the parallel flash loader (PFL) IP to program the quad SPI flash, you need to generate a **.pof** (Programmer Object file) to configure the device.

Perform the following steps to generate a **.pof** file:

1. Create a byte-order `Quartus.ini` file with the setting:

```
PGMIO_SWAP_HEX_BYTE_DATA=ON
```

2. Copy the **.ini** file to the project root directory and open the project with Quartus
3. Open **Convert Programming Files** tool to generate the **.pof** file

Table 4-24: Default Memory Map of the 512-Mb QSPI Flash

Block Description	Size (KB)	Address Range
Board test system scratch	512	0x03F8.0000 – 0x03FF.FFFF
User software	56640	0x0083.0000 – 0x03F7.FFFF
Factory software	4096	0x0043.0000 – 0x0082.FFFF
Zips(html, web content)	4096	0x0003.0000 – 0x0042.FFFF
Board information	64	0x0002.0000 – 0x0002.FFFF
Ethernet option bits	64	0x0001.0000 – 0x0001.FFFF
User design reset vector	64	0x0000.0000 – 0x0000.FFFF

Table 4-25: Flash Pin Assignments, Schematic Signal Names, and Functions

Board Reference (U7)	Schematic Signal Name	Max 10 FPGA Pin Number	I/O Standard	Description
U7.7	QSPI_CS _n	C2	3.3V	Chip select
U7.16	QSPI_CLK	B2	3.3V	Clock
U7.3	QSPI_RESETh	W12 (MAX II)	3.3V	Reset
U7.15	QSPI_IO0	C6	3.3V	Address bus
U7.8	QSPI_IO1	C3	3.3V	Address bus

Board Reference (U7)	Schematic Signal Name	Max 10 FPGA Pin Number	I/O Standard	Description
U7.9	QSPI_IO2	C5	3.3V	Address bus
U7.1	QSPI_IO3	B1	3.3V	Address bus

Power Distribution System

This topic shows the power tree drawing for the MAX 10 FPGA development board. Regulator inefficiencies and sharing are reflected in the currents shown, which are conservative absolute maximum levels.

Figure 4-4: Power Distribution System

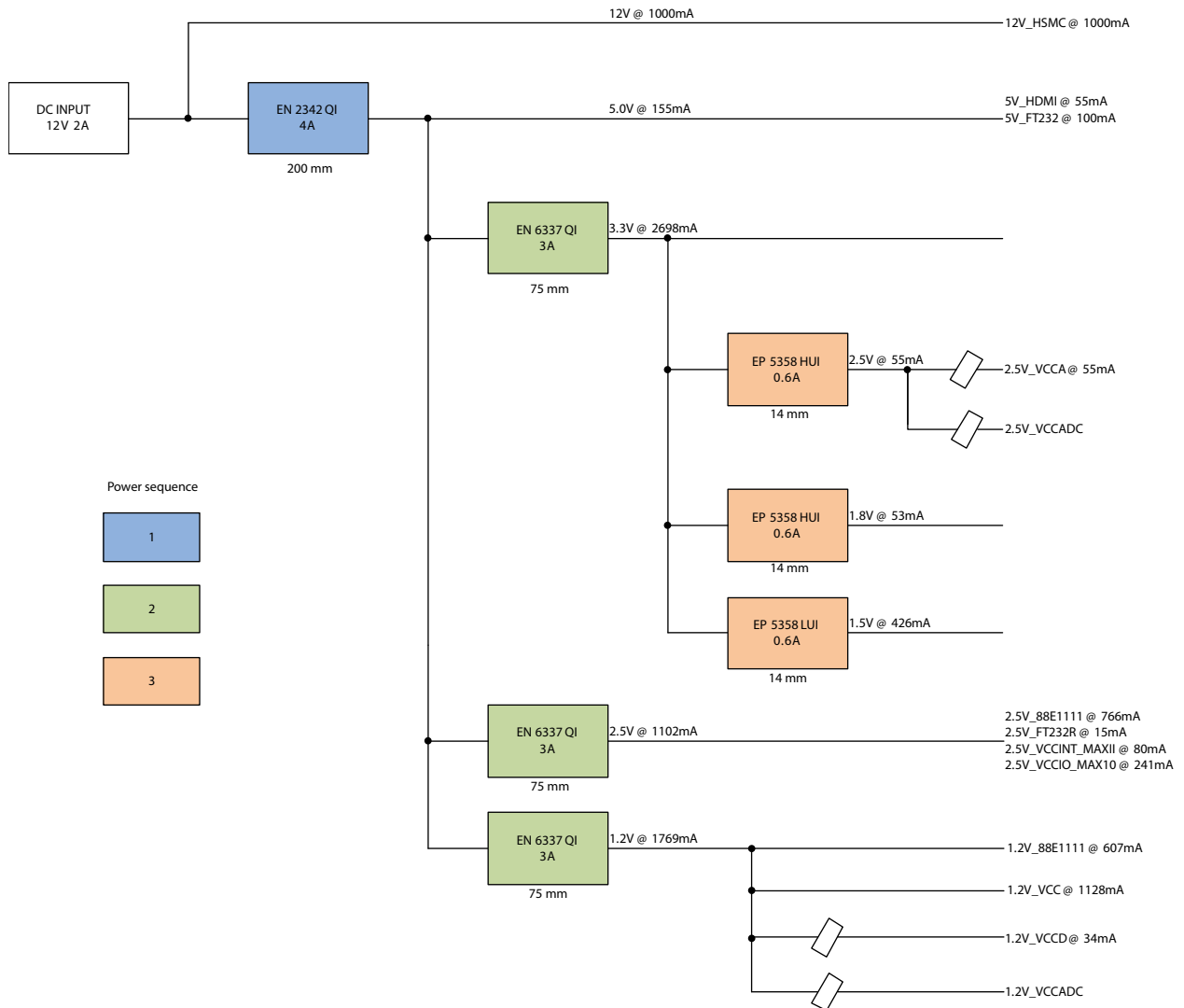

2017.09.07

UG-01169



Subscribe



Send Feedback

User Guide Revision History

Table A-1: MAX 10 FPGA Development Kit User Guide Revision History

Date	Version	Changes
September 2017	2017.09.07	Updated I/O standard voltage values in the On-Board Oscillators table in On-Board Oscillators on page 4-10
January 2017	2017.01.04	Corrected the following pin assignments in "10/100/1000 Ethernet PHY": <ul style="list-style-type: none"> • ENETA_TX_D1 on pin P5 • ENETA_RX_ER on pin U2 • ENET_MDIO on pin Y5 • ENETB_TX_D2 on pin U3 • ENETB_RS_D3 on pin R7
November 2015	2015.11.06	<ul style="list-style-type: none"> • Updated "USB to UART" section. • Added note to "General User Input/Output section".
June 2015	2015.06.26	<ul style="list-style-type: none"> • Updated "DDR3 Rev. B Board" section.
May 2015	2015.05.21	<ul style="list-style-type: none"> • Added quad SPI content for Rev. B & C boards. • Corrected two PMOD pin signal names for Rev. B & C boards. • Changed four MAX 10 pins for DDR3 for Rev. C board only. • Changed two switch/signal names for SW2 for Rev. C board only. • Updated <i>Switch and Jumper Settings</i> section with VTAP description.
March 2015	2015.03.31	Initial release.

Intel Corporation. All rights reserved. Intel, the Intel logo, Altera, Arria, Cyclone, Enpirion, MAX, Nios, Quartus and Stratix words and logos are trademarks of Intel Corporation or its subsidiaries in the U.S. and/or other countries. Intel warrants performance of its FPGA and semiconductor products to current specifications in accordance with Intel's standard warranty, but reserves the right to make changes to any products and services at any time without notice. Intel assumes no responsibility or liability arising out of the application or use of any information, product, or service described herein except as expressly agreed to in writing by Intel. Intel customers are advised to obtain the latest version of device specifications before relying on any published information and before placing orders for products or services.

*Other names and brands may be claimed as the property of others.

ISO
9001:2008
Registered

ALTERA
now part of Intel

Compliance and Conformity Statements

CE EMI Conformity Caution

This board is delivered conforming to relevant standards mandated by Directive 2004/108/EC. Because of the nature of programmable logic devices, it is possible for the user to modify the kit in such a way as to generate electromagnetic interference (EMI) that exceeds the limits established for this equipment. Any EMI caused as the result of modifications to the delivered material is the responsibility of the user.

