

Model:LN142-6

Characteristics:

It is used for switching power supply, suppressing common mode interference signal.

Technical index:

- Installation method: PCB
- Flame resistance: UL94-V0
- Operating temperature: -20°C ~ +100°C
- Storage temperature: -20°C ~ +100°C
- Frequency range: DC ~ 1KHz
- Dielectric strength: 1.5KV/1min (between two coils)
4KV/1min (between coil & shell)



Electrical parameters:

Rated current	6	A
Inductance 1KHz,0.3V	1.8	mH
Inductance error	-30 ~ +50	%
DC resistance	20	mΩ
Maximum operating voltage	250	V
Permissible inrush current	20 times of rated current(ms)	
Weight	35.4	g

Schematic wiring diagram:

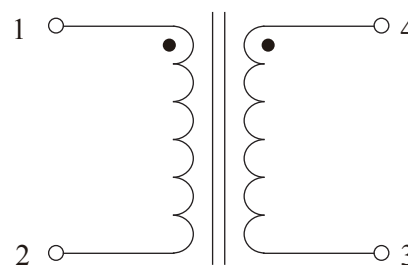

Dimensions(in mm):

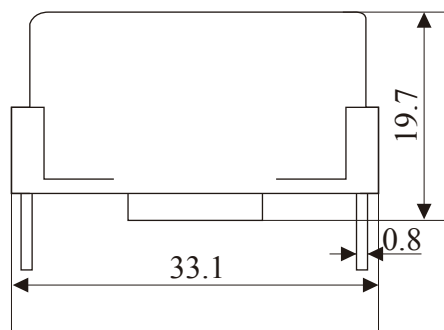

Front View

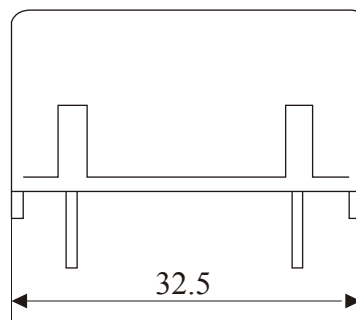

Side View

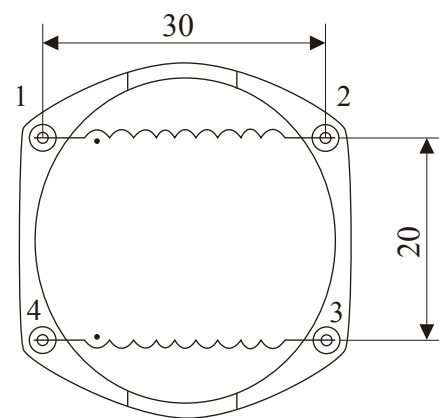

Bottom View