



W83194BR-372

**WINBOND
CLOCK GENERATOR
FOR SIS 746/748 CHIPSETS**



Table of Contents-

1.	GENERAL DESCRIPTION	1
2.	PRODUCT FEATURES	1
3.	PIN CONFIGURATION	2
4.	BLOCK DIAGRAM	2
5.	PIN DESCRIPTION.....	3
5.1	Crystal I/O	3
5.2	CPU, AGP, ZCLK and PCI, IOAPIC Clock Outputs.....	3
5.3	Fixed Frequency Outputs.....	4
5.4	I ² C Control Interface	4
5.5	Power Management Pins.....	4
5.6	Power Pins.....	4
6.	FREQUENCY SELECTION BY HARDWARE OR SOFTWARE	5
7.	I ² C CONTROL AND STATUS REGISTERS.....	6
7.1	Register 0: Frequency Select (Default = 40h)	6
7.2	Register 1: CPU Clock (1 = Enable, 0 = Stopped) (Default: 68h).....	6
7.3	Register 2: PCI Clock (1 = Enable, 0 = Stopped) (Default: FFh).....	6
7.4	Register 3: AGP, 24_48MHz, 48MHz, REF Control (1 =Enable, 0 =Stopped) (Default: FFh) 7	7
7.5	Register 4: IOAPIC, ZCLK Control (1 = Enable, 0 = Stopped) (Default: F0h)	7
7.6	Register 5: 24_48MHz Control (Default: 88h)	7
7.7	Register 6: M/N (Default: 90h)	8
7.8	Register 7: N (Default: BBh).....	8
7.9	Register 8: Winbond Chip ID (Default: 72h) (Read only).....	8
7.10	Register 9: Reserved (Default: 50h) (Read only)	9
7.11	Register 10: M/N Program (Default: 04h).....	9
7.12	Register 11: Spread Spectrum Programming (Default: 0Eh)	10
7.13	Register 12: Divisor and Step-less Enable Control (Default: 88h).....	10
7.14	Register 13: FIX Mode Control (Default: 0Fh).....	12
7.15	Register 14: Fix Mode Control (Default: 2Ch)	12
7.16	Register 15: Skew Control (Default: E4h).....	13
8.	ACCESS INTERFACE	14
8.1	Block Write Protocol	14
8.2	Block Read Protocol.....	14

W83194BR-372



8.3	Byte Write Protocol.....	14
8.4	Byte Read Protocol.....	14
9.	SPECIFICATIONS	15
9.1	Absolute Maximum Ratings	15
9.2	General Operating Characteristics	15
9.3	Skew Group Timing Clock	15
9.4	CPU (Open Drain) Electrical Characteristics.....	16
9.5	AGP, ZCLK Electrical Characteristics.....	16
9.6	PCI Electrical Characteristics.....	16
9.7	24M, 48M Electrical Characteristics	17
9.8	REF Electrical Characteristics.....	17
9.9	IOAPIC Electrical Characteristics	17
10.	ORDERING INFORMATION.....	18
11.	HOW TO READ THE TOP MARKING.....	18
12.	PACKAGE DRAWING AND DIMENSIONS.....	19
13.	REVISION HISTORY	20



1. GENERAL DESCRIPTION

The W83194BR-372 is a Clock Synthesizer for SIS 746/748 chipset. W83194BR-372 provides all clocks required for high-speed microprocessor and provides step-less frequency programming and 32 different frequencies of CPU, PCI, and AGP clocks setting, support two ZCLK clock outputs; all clocks are externally selectable with smooth transitions.

The W83194BR-372 provides I²C serial bus interface to program the registers to enable or disable each clock outputs and provides -0.5% and +/-0.25% center type spread spectrum or programmable S.S.T. scale to reduce EMI.

The W83194BR-372 accepts a 14.318 MHz reference crystal as its input and runs on a 3.3V supply.

2. PRODUCT FEATURES

- 1 2.5V open drain Differential pairs clock outputs for CPU
- 1 2.5V open drain singled-ended clock output for chipset host bus.
- 2 3.3V ZCLK clock outputs
- 2 AGP clock outputs
- 8 PCI synchronous clocks
- 2 2.5V IOAPIC clock outputs
- 1 24_48Mhz clock output for super I/O.
- 1 48 MHz clock output for USB.
- 3 14.318MHz REF clock outputs.
- ZCLK/AGP/PCI clock out supports synchronous and asynchronous mode
- Smooth frequency switch with selections from 100 to 200MHz
- Step-less frequency programming
- I²C 2-Wire serial interface and support byte read/write and block read/write.
- -0.5% and +/- 0.25% center type spread spectrum
- Programmable S.S.T. scale to reduce EMI
- Programmable registers to enable/stop each output and select modes
- Programmable clock outputs Skew control
- 48-pin SSOP package



3. PIN CONFIGURATION

VDDREF	1	48	VDDI
FS0*/REF0	2	47	IOAPIC1
FS1*/REF1	3	46	IOAPIC0
REF2	4	45	GND
GND	5	44	CPU_STOP#*
XIN	6	43	CPUT1
XOUT	7	42	VDDCPU
GND	8	41	GND
ZCLK0	9	40	CPU0
ZCLK1	10	39	CPUC0
VDDZ	11	38	VDDCPU
PCI_STOP#*	12	37	GND
VDDPCI	13	36	VDDA
FS2*/PCL_F0	14	35	SCLK*
FS3*/PCL_F1	15	34	SDATA*
PCI0	16	33	PD#*
PCI1	17	32	GND
GND	18	31	AGP_0
VDDPCI	19	30	AGP_1
PCI2	20	29	VDDAGP
PCI3	21	28	VDD48
PCI4	22	27	48MHz
PCI5	23	26	24_48MHz
GND	24	25	GND

#: Active low
 *: Internal pull up resistor 120K to VDD
 &.: Internal Pull-down resistor 120K to GND

4. BLOCK DIAGRAM

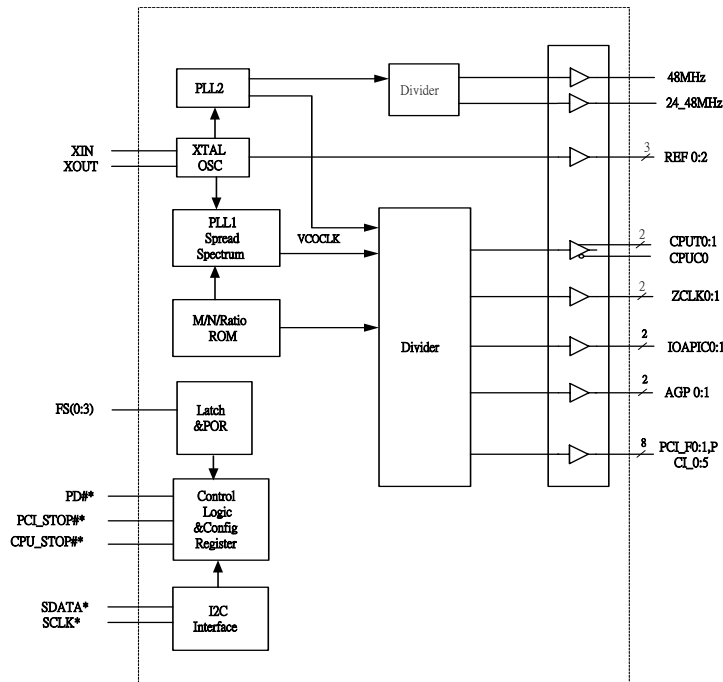



5. PIN DESCRIPTION

BUFFER TYPE SYMBOL	DESCRIPTION
IN	Input
IN _{tp120k}	Latched input at power up, internal 120kΩ pull up.
IN _{td120k}	Latched input at power up, internal 120kΩ pull down.
OUT	Output
OD	Open Drain
#	Active Low
*	Internal 120kΩ pull-up
&	Internal 120 kΩ pull-down

5.1 Crystal I/O

PIN	PIN NAME	TYPE	DESCRIPTION
6	XIN	IN	Crystal input with internal loading capacitors (18pF) and feedback resistors.
7	XOUT	OUT	Crystal output at 14.318MHz nominally with internal loading capacitors (18pF).

5.2 CPU, AGP, ZCLK and PCI, IOAPIC Clock Outputs

PIN	PIN NAME	TYPE	DESCRIPTION
40,39	CPUT0 CPUC0	OD	2.5V open drain differential clock outputs for AMD K7 CPU
43	CPUT1	OD	2.5V open drain singled –ended synchronize with CPUT0, For chipset host bus
31,30	AGP_0: 1	OUT	3.3V AGP clock outputs.
9,10	ZCLK0: 1	OUT	3.3V ZCLK clock outputs, For MuTIOIOL bus.
14	PCI_F0	OUT	3.3V PCI free running clock output.
	FS2&	IN _{td120k}	Latched input for FS2 at initial power up for H/W selecting the output frequency. This is internal 120K pull down.
15	PCI_F1	OUT	3.3V PCI free running clock output.
	FS3*	IN _{tp120k}	Latched input for FS3 at initial power up for H/W selecting the output frequency, This is internal 120K pull up.
16, 17, 20, 21, 22, 23	PCI [0:5]	OUT	Low skew (< 250ps) PCI clock outputs.
47, 46	IOAPIC [0:1]	OUT	2.5V IOAPIC outputs.



5.3 Fixed Frequency Outputs

PIN	PIN NAME	TYPE	DESCRIPTION
2	REF0	OUT	14.318MHz output.
	FS0 ^{&}	IN _{td120k}	Latched input for FS0 at initial power up for H/W selecting the output frequency. This is internal 120K pull down.
3	REF1	OUT	14.318MHz output.
	FS1 ^{&}	IN _{td120k}	Latched input for FS1 at initial power up for H/W selecting the output frequency. This is internal 120K pull down.
4	REF2	OUT	14.318MHz output.
27	48MHz	OUT	48MHz clock output for USB.
26	24_48MHz	OUT	24MHz (default) or 48MHz clock output, it could be R/W by I2C control after power on reset period. Select by register 5 bit 7.

5.4 I²C Control Interface

PIN	PIN NAME	TYPE	DESCRIPTION
34	SDATA*	I/OD	Serial data of I ² C 2-wire control interface with internal pull-up resistor.
35	SCLK*	IN	Serial clock of I ² C 2-wire control interface with internal pull-up resistor.

5.5 Power Management Pins

PIN	PIN NAME	TYPE	DESCRIPTION
33	PD#*	IN _{tp120k}	Power Down Function. This is power down pin, low active (PD#). Internal 120K pull up
12	PCI_STOP#*	IN _{tp120k}	Active low, Stop all PCI clock output besides the free running clocks.
44	CPU_STOP#*	IN _{tp120k}	Active low, Stop all CPU clock outputs.

5.6 Power Pins

PIN	PIN NAME	TYPE	DESCRIPTION
1	VDDREF	PWR	3.3V power supply for REF.
13,19	VDDPCI	PWR	3.3V power supply for PCI.
29	VDDAGP	PWR	3.3V power supply for AGP.
38,42	VDDCPU	PWR	2.5V power supply for CPU.
28	VDD48	PWR	3.3V power supply for 48MHz.
11	VDDZ	PWR	3.3V power supply for ZCLK.
48	VDDI	PWR	2.5V power supply for IOAPIC
36	VDDA	PWR	3.3V power supply for Analog core logic.
5, 8, 18, 24, 25, 32, 37, 41, 45	GND	PWR	Ground pin



6. FREQUENCY SELECTION BY HARDWARE OR SOFTWARE

This frequency table is used at power on latched FS [4:0] value or software programming at SSEL [4:0] (Register 0 bit 7 ~ 3).

FS4	FS3	FS2	FS1	FS0	CPU (MHZ)	ZCLK (MHZ)	AGP (MHZ)	PCI (MHZ)
0	0	0	0	0	133.34	66.67	66.67	33.33
0	0	0	0	1	133.34	66.67	50.00	33.33
0	0	0	1	0	133.34	100.00	66.67	33.33
0	0	0	1	1	133.34	100.00	50.00	33.33
0	0	1	0	0	133.34	133.34	66.67	33.33
0	0	1	0	1	133.34	133.34	50.00	33.33
0	0	1	1	0	133.34	166.67	66.67	33.33
0	0	1	1	1	133.34	166.67	55.56	33.33
0	1	0	0	0	100.00	66.67	66.67	33.33
0	1	0	0	1	100.00	66.67	50.00	33.33
0	1	0	1	0	100.00	100.00	66.67	33.33
0	1	0	1	1	100.00	100.00	50.00	33.33
0	1	1	0	0	100.00	133.34	66.67	33.33
0	1	1	0	1	166.67	133.34	66.67	33.33
0	1	1	1	0	110.97	166.45	66.58	33.29
0	1	1	1	1	110.97	166.45	55.48	33.29
1	0	0	0	0	114.55	95.45	63.64	31.82
1	0	0	0	1	119.91	99.93	66.62	33.31
1	0	0	1	0	133.34	83.34	66.67	33.33
1	0	0	1	1	133.34	111.12	74.08	33.33
1	0	1	0	0	133.34	133.34	83.34	33.33
1	0	1	0	1	145.64	116.51	64.73	32.37
1	0	1	1	0	149.89	99.93	66.62	66.31
1	0	1	1	1	166.67	111.12	66.67	33.33
1	1	0	0	0	111.12	133.34	66.67	33.33
1	1	0	0	1	137.37	137.37	68.68	34.34
1	1	0	1	0	144.97	144.97	64.43	32.22
1	1	0	1	1	149.89	149.89	66.62	33.31
1	1	1	0	0	155.04	124.03	68.91	34.45
1	1	1	0	1	166.67	133.34	66.67	33.33
1	1	1	1	0	180.17	135.13	67.56	33.78
1	1	1	1	1	200.01	133.34	66.67	33.33



7. I²C CONTROL AND STATUS REGISTERS

7.1 Register 0: Frequency Select (Default = 40h)

BIT	NAME	PWD	DESCRIPTION
7	SSEL [4]	0	Frequency selection by software via I ² C
6	SSEL [3]	1	
5	SSEL [2]	0	
4	SSEL [1]	0	
3	SSEL [0]	0	
2	EN_SSEL	0	Enable software table selection FS [4:0]. 0 = Hardware table setting (Jump mode). 1 = Software table setting through Bit7~3. (Jump less mode)
1	EN_SPSP	0	Enable spread spectrum mode under clock output. 0 = Spread Spectrum mode disable 1 = Spread Spectrum mode enable
0	Reserved	0	Reserved

7.2 Register 1: CPU Clock (1 = Enable, 0 = Stopped) (Default: 68h)

BIT	PIN NO	PWD	DESCRIPTION
7	Tri-state	0	Tri-state all output if set 1
6	43	1	CPUT1 output control
5	40,39	1	CPUT0 / C0 output control
4	-	X	Default: 0 (Read only)
3	15	X	Power on latched value of FS3 pin. Default: 1 (Read only)
2	14	X	Power on latched value of FS2 pin. Default: 0 (Read only)
1	3	X	Power on latched value of FS1 pin. Default: 0 (Read only)
0	2	X	Power on latched value of FS0 pin. Default: 0 (Read only)

7.3 Register 2: PCI Clock (1 = Enable, 0 = Stopped) (Default: FFh)

BIT	PIN NO	PWD	DESCRIPTION
7	15	1	PCI_F1 output control
6	14	1	PCI_F0 output control
5	23	1	PCI5 output control
4	22	1	PCI4 output control
3	21	1	PCI3 output control
2	20	1	PCI2 output control
1	17	1	PCI1 output control
0	16	1	PCI0 output control



7.4 Register 3: AGP, 24_48MHz, 48MHz, REF Control (1 =Enable, 0 =Stopped) (Default: FFh)

BIT	PIN NO	PWD	DESCRIPTION
7	30	1	AGP_1 output control
6	31	1	AGP_0 output control
5	26	1	24_48MHz output control
4	27	1	48MHz output control
3	4	1	REF2 output control
2	3	1	REF1 output control
1	2	1	REF0 output control
0	-	1	Reserved

7.5 Register 4: IOAPIC, ZCLK Control (1 = Enable, 0 = Stopped) (Default: F0h)

BIT	PIN NO	PWD	DESCRIPTION
7	47	1	IOAPIC1 output control
6	46	1	IOAPIC0 output control
5	10	1	ZCLK1 output control
4	9	1	ZCLK0 output control
3	-	0	Reserved
2	SEL<2>	0	Asynchronous ZCLK/AGP/PCI frequency table selection, SEL<2:0> 001: 132 / 66 / 33M 010:132 / 75.43 / 37.7M 011: 132 / 88 / 44M 100:176 / 88 / 44M 101: 132 / 66 / 33M 110:132 / 75.43 / 33M 111: 132 / 88 / 33M 000: Clock from PLL1
1	SEL<1>	0	
0	SEL<0>	0	

7.6 Register 5: 24_48MHz Control (Default: 88h)

BIT	NAME	PWD	DESCRIPTION
7	SEL24_48	1	24 / 48 MHz output selection, 1: 24 MHz (Default), 0: 48 MHz.
6	Reserved	0	Reserved
5	Reserved	0	Reserved
4	Reserved	0	Reserved
3	Reserved	1	
2	Reserved	0	
1	Reserved	0	
0	Reserved	0	



7.7 Register 6: M/N (Default: 90h)

Bit	Name	PWD	DESCRIPTION
7	N<8>	1	Programmable M divisor
6	M<6>	0	
5	M<5>	0	
4	M<4>	1	
3	M<3>	0	
2	M<2>	0	
1	M<1>	0	
0	M<0>	0	

7.8 Register 7: N (Default: BBh)

BIT	NAME	PWD	DESCRIPTION
7	N<7>	1	Programmable N divisor bit 7 ~0. The bit 8 is defined in Register 6.
6	N<6>	0	
5	N<5>	1	
4	N<4>	1	
3	N<3>	1	
2	N<2>	0	
1	N<1>	1	
0	N<0>	1	

7.9 Register 8: Winbond Chip ID (Default: 72h) (Read only)

BIT	NAME	PWD	DESCRIPTION
7	CHPI_ID [7]	0	Winbond Chip ID. W83194BR-372 (SA5872).
6	CHPI_ID [6]	1	Winbond Chip ID.
5	CHPI_ID [5]	1	Winbond Chip ID.
4	CHPI_ID [4]	1	Winbond Chip ID.
3	CHPI_ID [3]	0	Winbond Chip ID.
2	CHPI_ID [2]	0	Winbond Chip ID.
1	CHPI_ID [1]	1	Winbond Chip ID.
0	CHPI_ID [0]	0	Winbond Chip ID.



7.10 Register 9: Reserved (Default: 50h) (Read only)

BIT	NAME	PWD	DESCRIPTION
7	Reserved	0	Reserved
6	Reserved	1	
5	Reserved	0	Reserved
4	Reserved	1	
3	Reserved	0	Reserved
2	Reserved	0	
1	Reserved	0	Reserved
0	Reserved	0	

7.11 Register 10: M/N Program (Default: 04h)

BIT	NAME	PWD	DESCRIPTION
7	EN_MN_PROG	0	<p>0: Output frequency depend on frequency table 1: Program all clock frequency by changing M/N value</p> <p>The equation is $VCO = 14.318MHz * (N+4) / M$.</p> <p>Once the watchdog timer timeout, the bit will be clear. Then the frequency will be decided by hardware default FS<4:0> or desired frequency select SAF_FREQ [4:0] depend on EN_SAFE_FREQ (Reg0 - bit 0).</p>
6	N<9>	0	Programmable N divisor bit 9.
5	Reserved	0	Reserved
4	IVAL<3>	0	Charge pump current selection
3	IVAL<2>	0	
2	IVAL<1>	1	
1	IVAL<0>	0	
0	Reserved	0	Reserved



7.12 Register 11: Spread Spectrum Programming (Default: 0Eh)

BIT	NAME	PWD	DESCRIPTION
7	SP_UP [3]	0	Spread Spectrum Up Counter bit 3 ~ bit 0.
6	SP_UP [2]	0	
5	SP_UP [1]	0	
4	SP_UP [0]	0	
3	SP_DOWN [3]	1	Spread Spectrum Down Counter bit 3 ~ bit 0 2's complement representation. Ex: 1 -> 1111; 2 -> 1110; 7 -> 1001; 8 -> 1000
2	SP_DOWN [2]	1	
1	SP_DOWN [1]	1	
0	SP_DOWN [0]	0	

7.13 Register 12: Divisor and Step-less Enable Control (Default: 88h)

BIT	NAME	PWD	DESCRIPTION
7	Reserved	1	Reserved
6	Reserved	0	Reserved
5	Reserved	0	
4	DS4	0	Defined the CPU, ZCLK, AGP, PCI divider ratio
3	DS3	1	
2	DS2	0	
1	DS1	0	
0	DS0	0	

W83194BR-372



Table-2 CPU, ZCLK, AGP, PCI divider ratio selection Table

DS4	DS3	DS2	DS1	DS0	CPU Ratio	ZCLK Ratio	AGP Ratio	PCI Ratio
0	0	0	0	0	3	6	6	12
0	0	0	0	1	3	6	8	12
0	0	0	1	0	3	4	6	12
0	0	0	1	1	3	4	8	12
0	0	1	0	0	3	3	6	12
0	0	1	0	1	3	3	8	12
0	0	1	1	0	5	4	10	20
0	0	1	1	1	5	4	12	20
0	1	0	0	0	4	6	6	12
0	1	0	0	1	4	6	8	12
0	1	0	1	0	4	4	6	12
0	1	0	1	1	4	4	8	12
0	1	1	0	0	4	3	6	12
0	1	1	0	1	4	5	10	20
0	1	1	1	0	6	4	10	20
0	1	1	1	1	6	4	12	20
1	0	0	0	0	5	6	9	18
1	0	0	0	1	5	6	9	18
1	0	0	1	0	5	8	10	20
1	0	0	1	1	5	6	9	20
1	0	1	0	0	5	5	8	20
1	0	1	0	1	4	5	9	18
1	0	1	1	0	4	6	9	18
1	0	1	1	1	4	6	10	20
1	1	0	0	0	6	5	10	20
1	1	0	0	1	4	4	8	16
1	1	0	1	0	4	4	9	18
1	1	0	1	1	4	4	9	18
1	1	1	0	0	4	5	9	18
1	1	1	0	1	4	5	10	20
1	1	1	1	0	3	4	8	16
1	1	1	1	1	2	3	6	12



7.14 Register 13: FIX Mode Control (Default: 0Fh)

BIT	NAME	PWD	DESCRIPTION
7	FIX_PCI	0	PCI output frequency select mode (Valid only when SEL<2:0> is nonzero) 0: Output frequency according to frequency selection table 1: Output frequency according to FIX frequency table
6	FIX_ZCLK	0	ZCLK output frequency select mode (Valid only when SEL<2:0> is nonzero) 0: Output frequency according to frequency selection table 1: Output frequency according to FIX frequency table
5	SPCNT [5]	0	Spread Spectrum Programmable time, the resolution is 280ns. Default period is 11.8us
4	SPCNT [4]	0	
3	SPCNT [3]	1	
2	SPCNT [2]	1	
1	SPCNT [1]	1	
0	SPCNT [0]	1	

7.15 Register 14: Fix Mode Control (Default: 2Ch)

BIT	NAME	PWD	DESCRIPTION
7	Fix_AGP	0	AGP output frequency select mode 0: Output frequency according to frequency selection table 1: Output frequency according to FIX frequency table
6	INV_USB48	0	Invert the USB48 phase, 0: In phase with USB24_48 1: 180 degrees out of phase
5	Reserved	1	Reserved
4	SPSP1	0	Spread Spectrum type select. 00 : Down 1% 01 : Down 0.5% 10 : Center +/- 0.5% 11 : Center +/- 0.25%
3	SPSP0	1	
2	ASKEW [2]	1	CPU to AGP skew control, Skew resolution is 340ps Expand the skew direction is same as CPU_AGP_SKEW [2:0] setting
1	ASKEW [1]	0	
0	ASKEW [0]	0	



7.16 Register 15: Skew Control (Default: E4h)

BIT	NAME	PWD	DESCRIPTION
7	CPU1STOP_EN	1	Stop CPU1 clocks, 1: Enable stop feature, 0: Disable
6	CPU0STOP_EN	1	Stop CPU0 clocks, 1: Enable stop feature, 0: Disable
5	ZSKEW [2]	1	Reserved CPU to ZCLK skew control, Skew resolution is 340ps
4	ZSKEW [1]	0	Expand the skew direction is same as CPU_ZCLK_SKEW [2:0] setting
3	ZSKEW [0]	0	
2	PSKEW [2]	1	CPU to PCI skew control, Skew resolution is 340ps
1	PSKEW [1]	0	Expand the skew direction is same as CPU_PCI_SKEW [2:0] setting
0	PSKEW [0]	0	



8. ACCESS INTERFACE

The W83194BR-372 provides I²C Serial Bus for microprocessor to read/write internal registers. In the W83194BR-372 is provided Block Read/Block Write and Byte-Data Read/Write protocol. The I²C address is defined at 0xD2.

Block Read and Block Write Protocol

8.1 Block Write Protocol

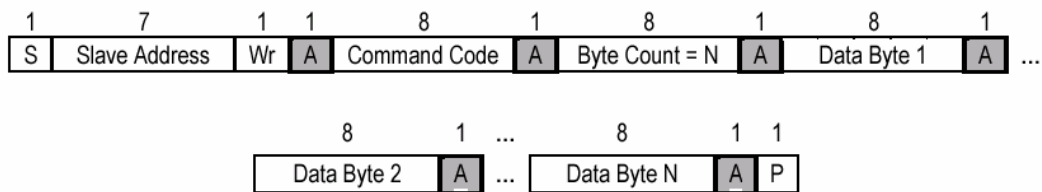

8.2 Block Read Protocol

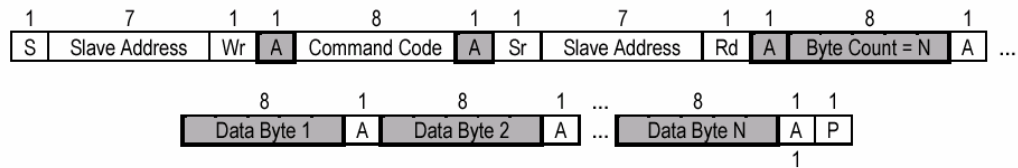

In block mode, the command code must filled 8'h00

8.3 Byte Write Protocol

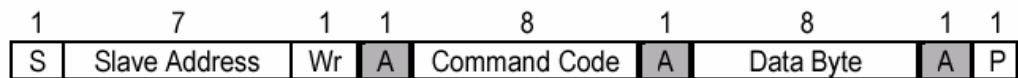

8.4 Byte Read Protocol

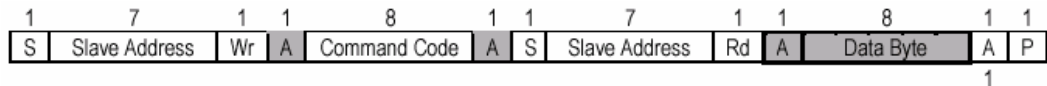



9. SPECIFICATIONS

9.1 Absolute Maximum Ratings

Stresses greater than those listed in this table may cause permanent damage to the device. Precautions should be taken to avoid application of any voltage higher than the maximum rated voltages to this circuit. Subjection to maximum conditions for extended periods may affect reliability. Unused inputs must always be tied to an appropriate logic voltage level (Ground or VDD).

PARAMETER	RATING
Absolute 3.3V Core Supply Voltage	-0.5V to +4.6V
Absolute 3.3V I/O Supply Voltage	- 0.5 V to + 4.6 V
Operating 3.3V Core Supply Voltage	3.135V to 3.465V
Operating 3.3V I/O Supply Voltage	3.135V to 3.465V
Storage Temperature	- 65°C to + 150°C
Ambient Temperature	- 55°C to + 125°C
Operating Temperature	0°C to + 70°C
Input ESD protection (Human body model)	2000V

9.2 General Operating Characteristics

VDD48=VDDAGP=VDDREF=VDDPCI= 3.3V ± 5 %, TA = 0°C to +70°C, CI=10pF					
PARAMETER	SYM.	MIN.	MAX.	UNITS	TEST CONDITIONS
Input Low Voltage	V _{IL}		0.8	V _{dc}	
Input High Voltage	V _{IH}	2.0		V _{dc}	
Output Low Voltage	V _{OL}		0.4	V _{dc}	All outputs using 3.3V power
Output High Voltage	V _{OH}	2.4		V _{dc}	All outputs using 3.3V power
Operating Supply Current	I _{dd}		350	mA	CPU = 100 to 200 MHz PCI = 33.3 Mhz with load
Input pin capacitance	C _{in}		5	pF	
Output pin capacitance	C _{out}		6	pF	
Input pin inductance	L _{in}		7	nH	

9.3 Skew Group Timing Clock

VDD48=VDDAGP=VDDREF=VDDPCI = 3.3V ± 5 %, TA = 0°C to +70°C, CI=10pF					
PARAMETER	MIN.	TYP.	MAX.	UNITS	TEST CONDITIONS
AGP to PCI Skew	1.5	2.6	3.5	ns	Measured at 1.5V
CPU to CPU Skew			200	ps	Crossing point
AGP to AGP Skew			250	ps	Measured at 1.5V
PCI to PCI Skew			500	ps	Measured at 1.5V
48MHz to 48MHz Skew			1000	ps	Measured at 1.5V
REF to REF Skew			500	ps	Measured at 1.5V



9.4 CPU (Open Drain) Electrical Characteristics

<i>VDDCPU= 2.5V ± 5 %, TA = 0°C to +70°C, external 1.5V pull-up</i>				
PARAMETER	MIN.	MAX.	UNITS	TEST CONDITIONS
Rise Time	-	900	ps	100 to 200 Mhz, Vol=20%, Voh=80%
Fall Time	-	900	ps	100 to 200Mhz, Vol=20%, Voh=80%
Absolute crossing point Voltages	550	1250	mV	100 to 200Mhz
Cycle to Cycle jitter		250	ps	100 to 200Mhz
Duty Cycle	45	55	%	100 to 200Mhz

9.5 AGP, ZCLK Electrical Characteristics

<i>VDDAGP=VDDZ= 3.3V ± 5 %, TA = 0°C to +70°C, Test load, Cl=10pF,</i>				
PARAMETER	MIN.	MAX.	UNITS	TEST CONDITIONS
Rise Time	500	2000	ps	Measure from 0.4V to 2.4V
Fall Time	500	2000	ps	Measure from 2.4V to 0.4V
Cycle to Cycle jitter		250	ps	Measure 1.5V point
Duty Cycle	45	55	%	
Pull-Up Current Min	-33		mA	Vout=1.0V
Pull-Up Current Max		-33	mA	Vout=3.135V
Pull-Down Current Min	30		mA	Vout=1.95V
Pull-Down Current Max		38	mA	Vout=0.4V

9.6 PCI Electrical Characteristics

<i>VDDPCI= 3.3V ± 5 %, TA = 0°C to +70°C, Test load, Cl=10pF,</i>				
PARAMETER	MIN.	MAX.	UNITS	TEST CONDITIONS
Rise Time	500	2000	ps	Measure from 0.4V to 2.4V
Fall Time	500	2000	ps	Measure from 2.4V to 0.4V
Cycle to Cycle jitter		250	ps	Measure 1.5V point
Duty Cycle	45	55	%	
Pull-Up Current Min	-33		mA	Vout=1.0V
Pull-Up Current Max		-33	mA	Vout=3.135V
Pull-Down Current Min	30		mA	Vout=1.95V
Pull-Down Current Max		38	mA	Vout=0.4V



9.7 24M, 48M Electrical Characteristics

VDD48= 3.3V \pm 5 %, TA = 0°C to +70°C, Test load, Cl=10pF,				
PARAMETER	MIN.	MAX.	UNITS	TEST CONDITIONS
Rise Time	500	2000	ps	Measure from 0.4V to 2.4V
Fall Time	500	2000	ps	Measure from 2.4V to 0.4V
Long term jitter		500	ps	Measure 1.5V point
Duty Cycle	45	55	%	
Pull-Up Current Min	-33		mA	Vout=1.0V
Pull-Up Current Max		-33	mA	Vout=3.135V
Pull-Down Current Min	30		mA	Vout=1.95V
Pull-Down Current Max		38	mA	Vout=0.4V

9.8 REF Electrical Characteristics

VDDREF= 3.3V \pm 5 %, TA = 0°C to +70°C, Test load, Cl=10pF,				
PARAMETER	MIN.	MAX.	UNITS	TEST CONDITIONS
Rise Time	1000	4000	ps	Measure from 0.4V to 2.4V
Fall Time	1000	4000	ps	Measure from 2.4V to 0.4V
Cycle to Cycle jitter		1000	ps	Measure 1.5V point
Duty Cycle	45	55	%	
Pull-Up Current Min	-33		mA	Vout=1.0V
Pull-Up Current Max		-33	mA	Vout=3.135V
Pull-Down Current Min	30		mA	Vout=1.95V
Pull-Down Current Max		38	mA	Vout=0.4V

9.9 IOAPIC Electrical Characteristics

VDDI= 2.5V \pm 5 %, TA = 0°C to +70°C, Test load, Cl=10pF,				
PARAMETER	MIN.	MAX.	UNITS	TEST CONDITIONS
Rise Time	400	1600	ps	Measure from 0.4V to 2.0V
Fall Time	400	1600	ps	Measure from 2.0V to 0.4V
Cycle to Cycle jitter		500	ps	Measure 1.25V point
Duty Cycle	45	55	%	
Pull-Up Current Min	-27		mA	Vout=1.0V
Pull-Up Current Max		-27	mA	Vout=2.375V
Pull-Down Current Min	27		mA	Vout=1.2V
Pull-Down Current Max		30	mA	Vout=0.3V

W83194BR-372



10. ORDERING INFORMATION

PART NUMBER	PACKAGE TYPE	PRODUCTION FLOW
W83194BR-372	48 PIN SSOP	Commercial, 0°C to +70°C

11. HOW TO READ THE TOP MARKING

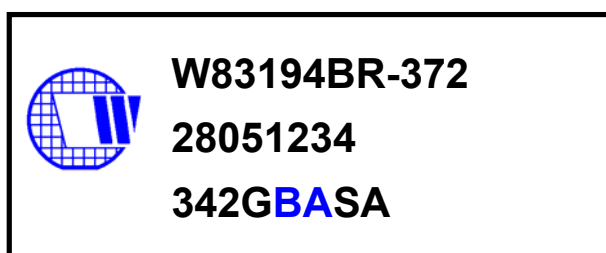

1st line: Winbond logo and the type number: W83194BR-372

2nd line: Tracking code 2 8051234

2: wafers manufactured in Winbond FAB 2

8051234: wafer production series lot number

3rd line: Tracking code 342 G A A SA

342: packages made in '2003, week 42

G: assembly house ID; O means OSE, G means GR

A: Internal use code

A: IC revision

SA: mask version

All the trademarks of products and companies mentioned in this data sheet belong to their respective owners.



12. PACKAGE DRAWING AND DIMENSIONS

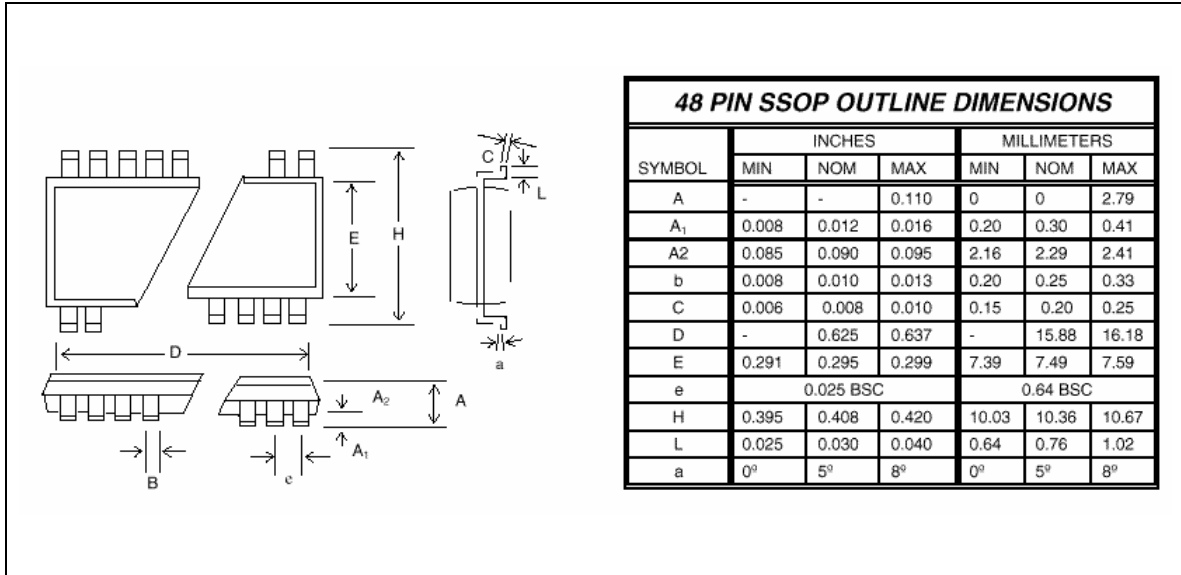



13. REVISION HISTORY

VERSION	DATE	PAGE	DESCRIPTION
			All of the versions before 0.50 are for internal use.
0.5	09/03/03	n.a.	First published preliminary version.
0.6	10/01/03	1, 6, 7, 10, 11, 12, 16, 17	Modify some description, red text.
0.7	12/18/03	18	Correction IC version, correction some description and default value
0.8	04/27/04	5, 11	Change frequency table '01101'
1.0	12/28/04		Update on Web
1.1	4/13/2005	20	Add disclaimer

Important Notice

Winbond products are not designed, intended, authorized or warranted for use as components in systems or equipment intended for surgical implantation, atomic energy control instruments, airplane or spaceship instruments, transportation instruments, traffic signal instruments, combustion control instruments, or for other applications intended to support or sustain life. Further more, Winbond products are not intended for applications wherein failure of Winbond products could result or lead to a situation wherein personal injury, death or severe property or environmental damage could occur.

Winbond customers using or selling these products for use in such applications do so at their own risk and agree to fully indemnify Winbond for any damages resulting from such improper use or sales.



Headquarters

No. 4, Creation Rd. III,
Science-Based Industrial Park,
Hsinchu, Taiwan
TEL: 886-3-5770066
FAX: 886-3-5665577
<http://www.winbond.com.tw/>

Taipei Office

9F, No.480, Rueiguang Rd.,
Neihu District, Taipei, 114,
Taiwan, R.O.C.
TEL: 886-2-8177-7168
FAX: 886-2-8751-3579

Winbond Electronics Corporation America

2727 North First Street, San Jose,
CA 95134, U.S.A.
TEL: 1-408-9436666
FAX: 1-408-5441798

Winbond Electronics Corporation Japan

7F Daini-ueno BLDG, 3-7-18
Shinyokohama Kohoku-ku,
Yokohama, 222-0033
TEL: 81-45-4781881
FAX: 81-45-4781800

Winbond Electronics (Shanghai) Ltd.

27F, 2299 Yan An W. Rd. Shanghai,
200336 China
TEL: 86-21-62365999
FAX: 86-21-62365998

Winbond Electronics (H.K.) Ltd.

Unit 9-15, 22F, Millennium City,
No. 378 Kwun Tong Rd.,
Kowloon, Hong Kong
TEL: 852-27513100
FAX: 852-27552064

*Please note that all data and specifications are subject to change without notice.
All the trade marks of products and companies mentioned in this data sheet belong to their respective owners.*