

**HiRel RadHard Power-MOS**

- Low  $R_{DS(on)}$
- Single Event Effect (SEE) hardened  
 LET 85, Range: 118 $\mu$ m      LET 55, Range: 90 $\mu$ m  
 $V_{GS} = -10V, V_{DS} = 250V$        $V_{GS} = -15V, V_{DS} = 250V$   
 $V_{GS} = -15V, V_{DS} = 120V$        $V_{GS} = -20V, V_{DS} = 160V$
- Total Ionisation Dose (TID) hardened  
 100 kRad approved
- Hermetically sealed
- N-channel

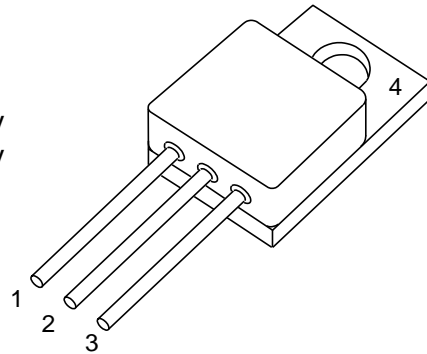

Type	Marking	Pin Configuration				Package
		1	2	3	4	
BUY25CS45B-01	-	D	S	G	Not connected	TO-254AA

**Maximum Ratings**

Parameter	Symbol	Values	Unit
Drain Source Voltage	$V_{DS}$	250	V
Gate Source Voltage	$V_{GS}$	+/- 20	V
Drain Gate Voltage	$V_{DG}$	250	V
Continuous Drain Current $T_C = 25\text{ }^\circ\text{C}$ $T_C = 100\text{ }^\circ\text{C}$	$I_D$	45 29	A
Continuous Source Current	$I_S$	45	A
Drain Current Pulsed, $t_p$ limited by $T_{jmax}$	$I_{DM}$	180	Apk
Total Power Dissipation <sup>1)</sup>	$P_{tot}$	208	W
Junction Temperature	$T_J$	-55 to + 150	$^\circ\text{C}$
Operating and Storage Temperature	$T_{op}$	-55 to + 150	$^\circ\text{C}$
Avalanche Energy	$E_{AS}$	380	mJ

**Thermal Characteristics**

Thermal Resistance (Junction to Case)	$R_{thJC}$	0.6	K/W
Soldering Temperature	$T_{sol}$	250	$^\circ\text{C}$

**Notes.:**

1) For  $T_S \leq 25^\circ\text{C}$ . For  $T_S > 25^\circ\text{C}$  derating is required.

**Electrical Characteristics, at  $T_A=25^\circ\text{C}$ ; unless otherwise specified**

Parameter	Symbol	Values		Unit
		min.	max.	
<b>DC Characteristics</b>				
Breakdown Voltage Drain to Source $I_D = 0.25\text{mA}$ , $V_{GS} = 0\text{V}$	$B_{VDSS}$	250	-	V
Gate Threshold Voltage $I_D = 1.0\text{mA}$ , $V_{DS} \geq V_{GS}$	$V_{GS(th)}$	2.0	4.0	V
Gate to Source Leakage Current $V_{DS} = 0\text{V}$ , $V_{GS} = +/- 20\text{V}$	$I_{GSS}$	-	+/-100	nA
Drain Current $V_{DS} = 200\text{V}$ , $V_{GS} = 0\text{V}$	$I_{DSS}$	-	25	$\mu\text{A}$
Drain Source On Resistance <sup>1)</sup> $V_{GS} = 10\text{V}$ , $I_D = 29\text{A}$	$r_{DS(ON)}$	-	0.05	$\Omega$
Source Drain Diode, Forward Voltage <sup>1), 2)</sup> $V_{GS} = 0\text{V}$ , $I_S = 45\text{A}$	$V_{SD}$	-	1.4	V
<b>AC Characteristics</b>				
Turn-on Delay Time $V_{DD} = 50\% V_{DS}$ , $I_D = 29\text{A}$ , $R_G = 4.7\Omega$	$t_{d(ON)}$	-	50	ns
Rise Time $V_{DD} = 50\% V_{DS}$ , $I_D = 29\text{A}$ , $R_G = 4.7\Omega$	$t_r$	-	95	ns
Turn-off Delay Time $V_{DD} = 50\% V_{DS}$ , $I_D = 29\text{A}$ , $R_G = 4.7\Omega$	$t_{d(OFF)}$	-	80	ns
Fall Time $V_{DD} = 50\% V_{DS}$ , $I_D = 29\text{A}$ , $R_G = 4.7\Omega$	$t_f$	-	75	ns
Reverse Recovery Time $V_{DD} < 50\% V_{DS}$ , $I_D = 45\text{A}$	$t_{rr}$	-	600	ns
Common Source Input Capacitance $V_{DS} = 100\text{V}$ , $V_{GS} = 0\text{V}$ , $f = 1.0\text{MHz}$	$C_{iss}$	3.5	6.5	nF
Common Source Output Capacitance $V_{DS} = 100\text{V}$ , $V_{GS} = 0\text{V}$ , $f = 1.0\text{MHz}$	$C_{oss}$	250	400	pF
Common Source Reverse Transfer Capacitance $V_{DS} = 100\text{V}$ , $V_{GS} = 0\text{V}$ , $f = 1.0\text{MHz}$	$C_{rss}$	5	20	pF
Total Gate Charge $V_{DD} = 50\% V_{DS}$ , $V_{GS} = 10\text{V}$ , $I_D = 45\text{A}$	$Q_G$	-	100	nC

**Notes.:**

 1) Pulsed Measurement: Pulse Width < 300 $\mu\text{s}$ , Duty Cycle <2.0%.

2) Measured within 2.0 mm of case.

**Electrical Characteristics**

 at  $T_A=125^\circ\text{C}$ ; unless otherwise specified

Parameter	Symbol	Values		Unit
		min.	max.	
<b>DC Characteristics</b>				
Gate Threshold Voltage $I_D = 1.0\text{mA}, V_{DS} \geq V_{GS}$	$V_{GS(th)}$	1.5	-	V
Gate to Source Leakage Current $V_{DS} = 0\text{V}, V_{GS} = +/- 20\text{V}$	$I_{GSS}$	-	+/-200	nA
Drain Current $V_{DS} = 200\text{V}, V_{GS} = 0\text{V}$	$I_{DSS}$	-	250	$\mu\text{A}$
Drain Source On Resistance <sup>1)</sup> $V_{GS} = 10\text{V}, I_D = 29\text{A}$	$r_{DS(ON)}$	-	0.09	$\Omega$

**Notes.:**

 1) Pulsed Measurement: Pulse Width < 300 $\mu\text{s}$ , Duty Cycle <2.0%.

**Electrical Characteristics**

 at  $T_A=-55^\circ\text{C}$ ; unless otherwise specified

Parameter	Symbol	Values		Unit
		min.	max.	
<b>DC Characteristics</b>				
Gate Threshold Voltage $I_D = 1.0\text{mA}, V_{DS} \geq V_{GS}$	$V_{GS(th)}$	-	5.0	V

### 1 Safe operating area

$I_D = f(V_{DS})$ ;  $T_C = 25^\circ\text{C}$   
parameter:  $t_p$

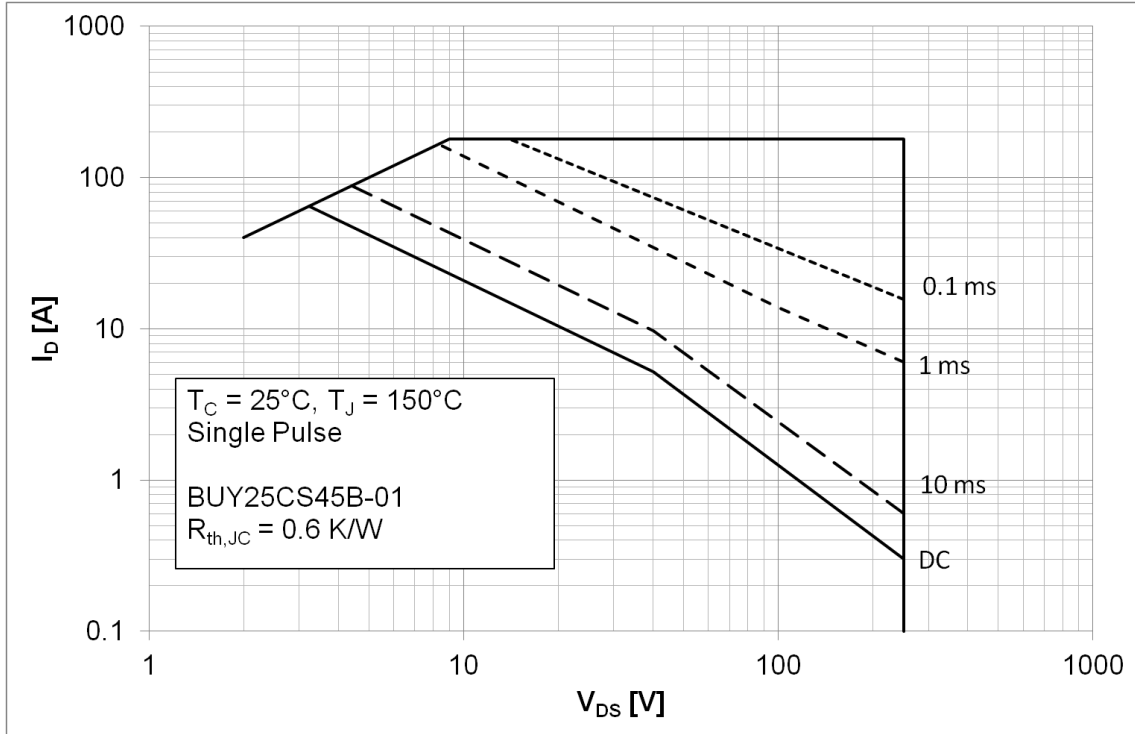

### 2 Max. transient thermal impedance

$Z_{thJC} = f(t_p)$   
parameter:  $D = t_p/T$

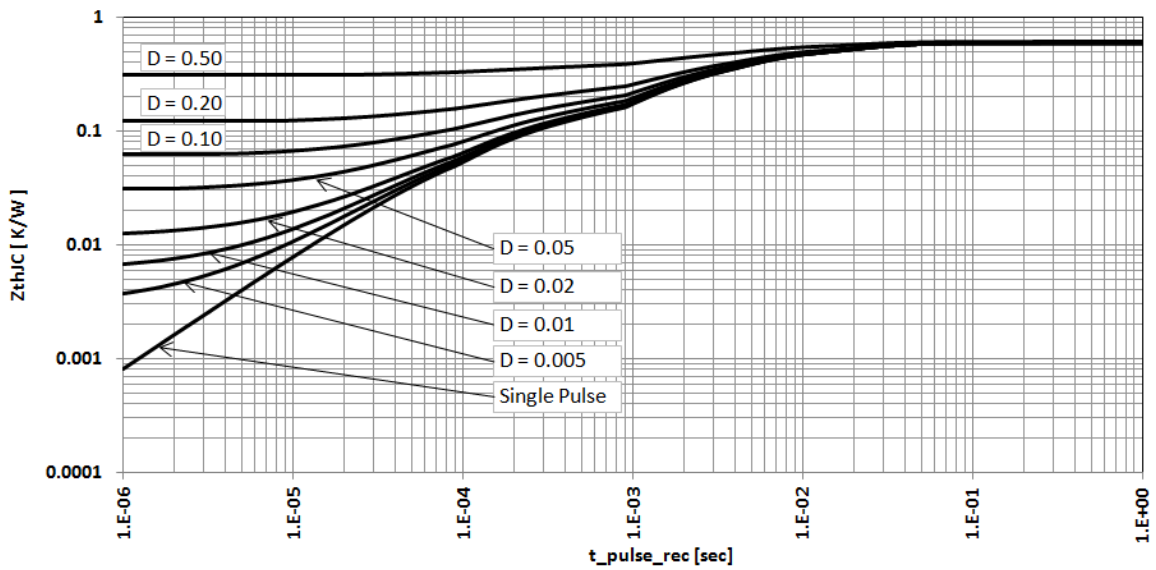

**3 Typ. output characteristics**

$I_D = f(V_{DS}); T_j = 25\text{ }^\circ\text{C}$   
parameter:  $V_{GS}$

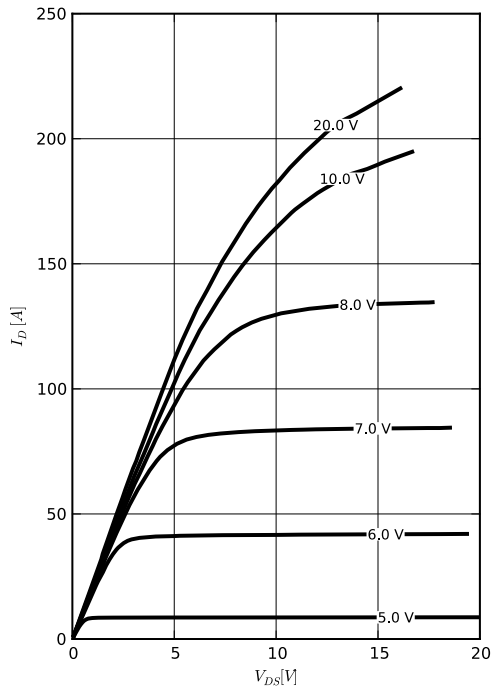

**4 Typ. output characteristics**

$I_D = f(V_{DS}); T_j = 150\text{ }^\circ\text{C}$   
parameter:  $V_G$

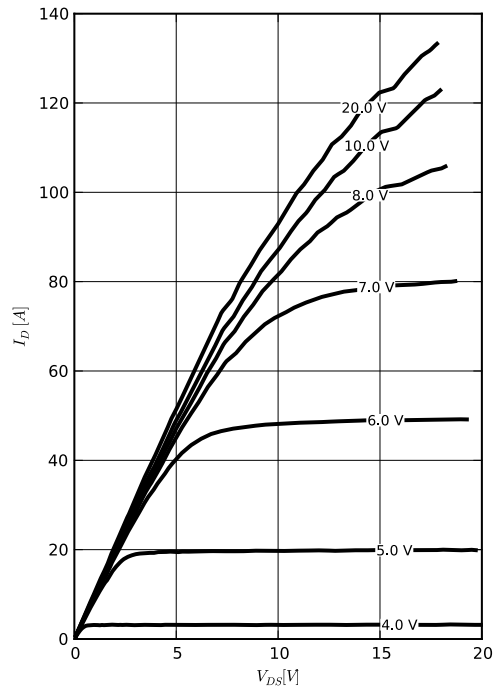

**5 Typ. drain-source on-state resistance**

$R_{DS(on)} = f(I_D); T_j = 150\text{ }^\circ\text{C}$   
parameter:  $V_{GS}$

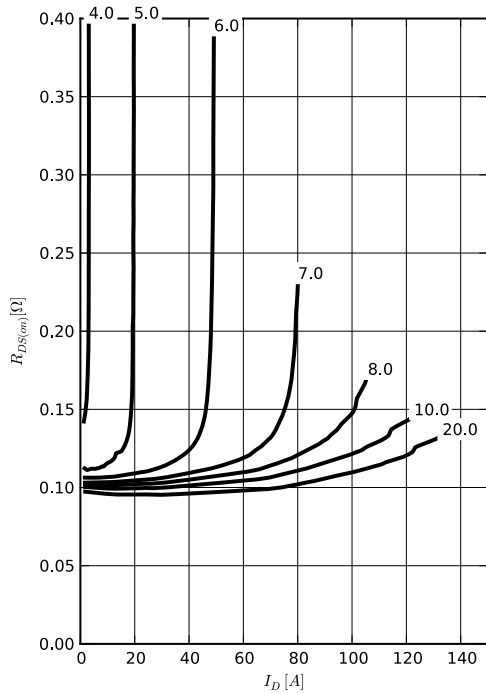

**6 Typ. drain-source on-state resistance**

$R_{DS(on)} = f(T_j)$   
 $I_D = 29\text{A}$

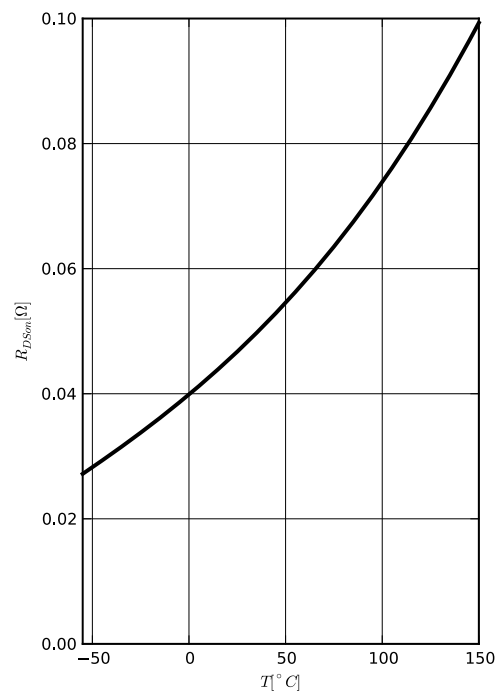

**7 Typ. transfer characteristics**

$I_D = f(V_{GS}); |V_{DS}| > 2 |I_D| R_{DS(on)max}$   
parameter:  $T_j$

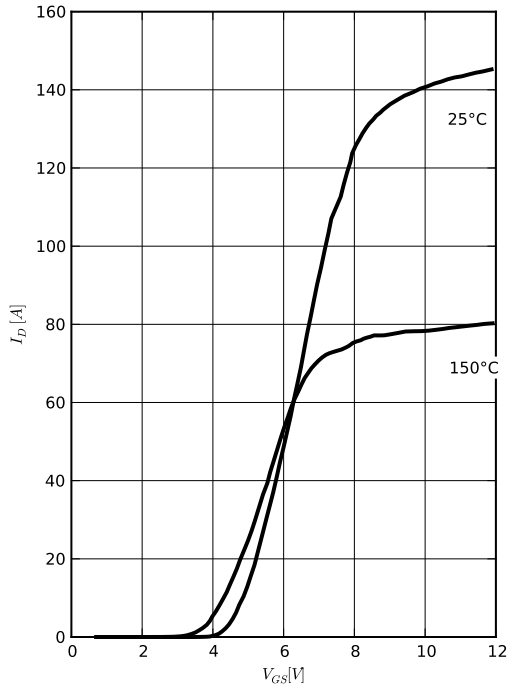

**8 Typ. gate threshold voltage**

$I_D = f(T_j)$   
 $I_D = 1mA$

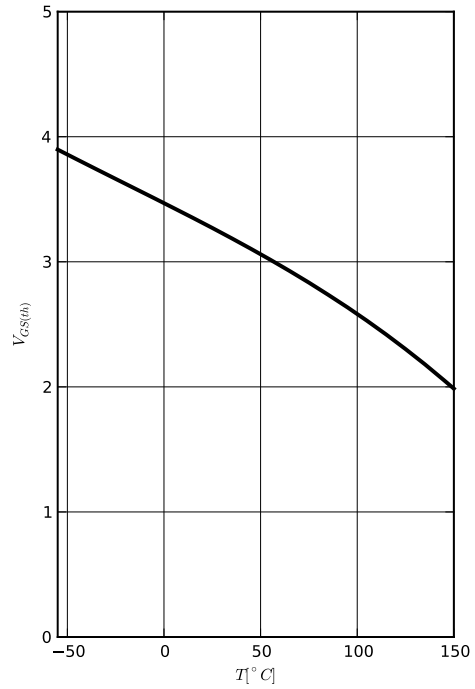

**9 Typ. forward characteristics of reverse diode**

$I_F = f(V_{SD})$   
parameter:  $T_j$

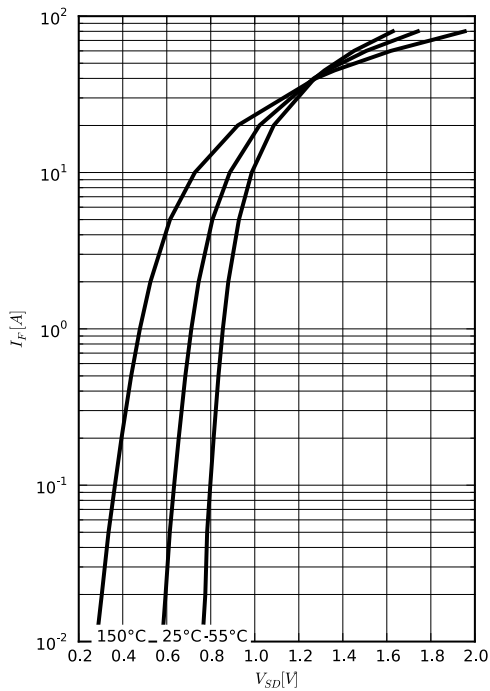

**10 Typ. drain-source breakdown voltage**

$BV_{DSS} = f(T_j)$   
 $I_D = 250\mu A$

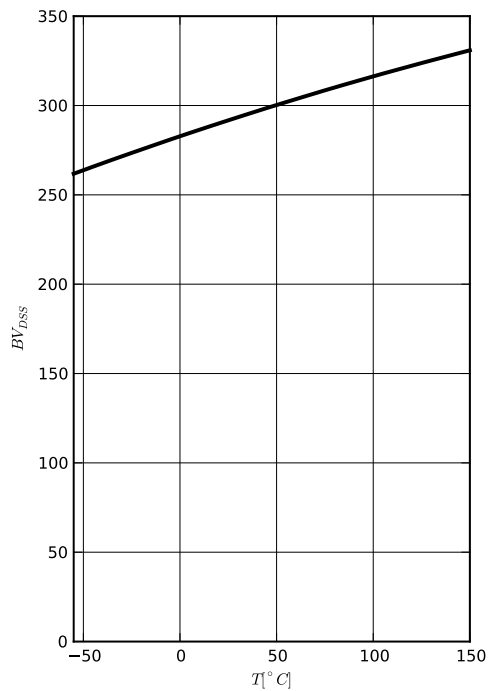

**11 Typ. capacitances**

$C = f(V_{DS}); V_{GS} = 0 \text{ V}; f = 1 \text{ MHz}$

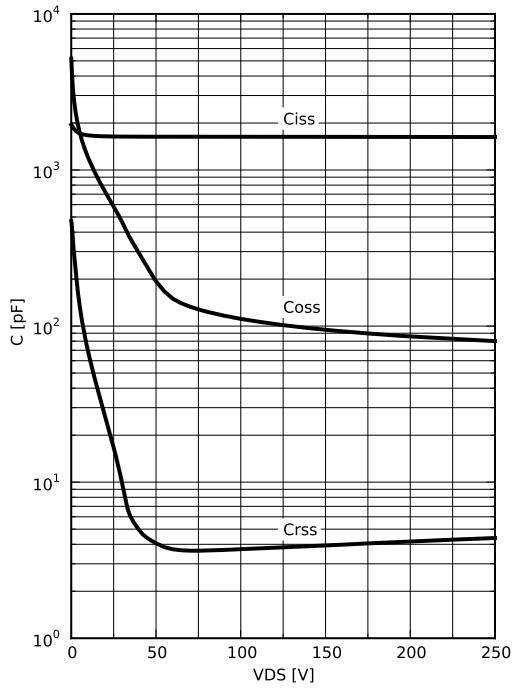

**12 Typ. gate charge**

$V_{GS} = f(Q_{gate}); I_D = 45.0 \text{ A pulsed}$   
parameter:  $V_{DD}$

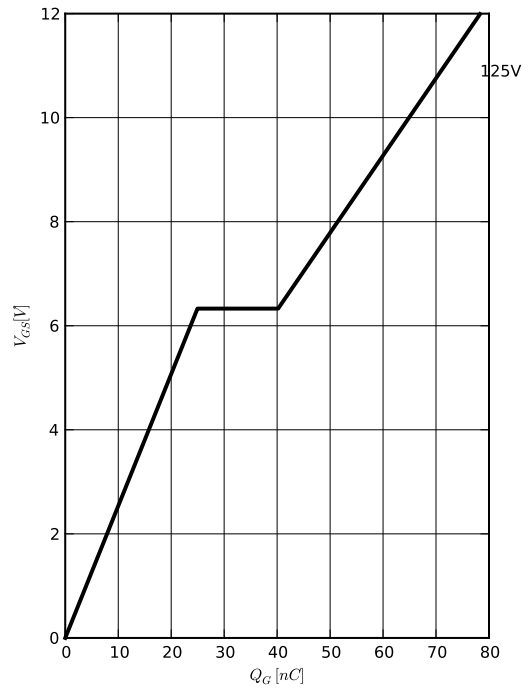

## TO-254AA Package

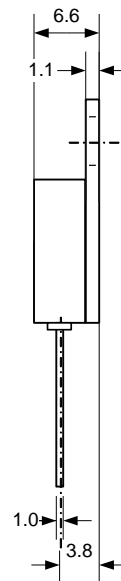
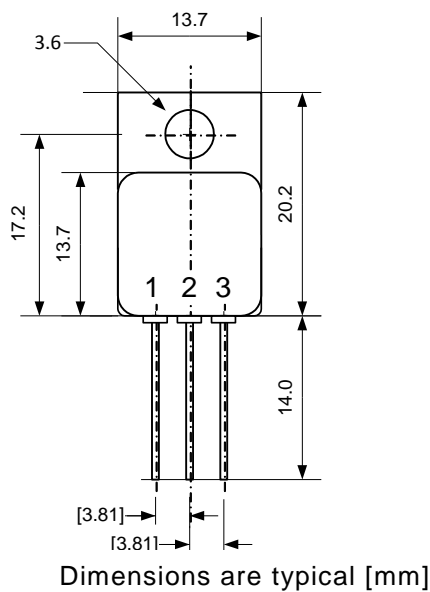

Edition 2015-03  
 Published by  
 Infineon Technologies AG  
 85579 Neubiberg, Germany  
 © Infineon Technologies AG 2015  
 All Rights Reserved.

### Caution

This package contains beryllia. Therefore it must not be in any form machined, grinded, sanded, polished or any other mechanical operation which will produce dust and particles.

### Attention please!

The information given in this document shall in no event be regarded as a guarantee of conditions or characteristics ("Beschaffenheitsgarantie"). With respect to any examples or hints given herein, any typical values stated herein and/or any information regarding the application of the device, Infineon Technologies hereby disclaims any and all warranties and liabilities of any kind, including without limitation warranties of non-infringement of intellectual property rights of a third party.

### Information

For further information on technology, delivery terms and conditions and prices please contact your nearest Infineon Technologies Office ([www.infineon.com](http://www.infineon.com)).

### Warnings

Due to technical requirements components may contain dangerous substances. For information on the types in question please contact your nearest Infineon Technologies Office.

Infineon Technologies Components may only be used in life-support devices or systems with the expressed written approval of Infineon Technologies, if a failure of such components can reasonably be expected to cause the failure of that life-support device or system, or to affect the safety or effectiveness of that device or system.

Life support devices or systems are intended to be implanted in the human body, or to support and/or maintain and sustain and/or protect human life. If they fail, it is reasonable to assume that the health of the user or other persons may be endangered.