

Shielded Axial Inductor

AIAS-03

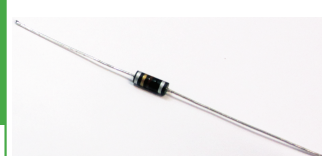

RoHS
Compliant



10.4 x ϕ 4.11 mm

FEATURES:

- Low cost.
- High Q and SRF, Low RDC.
- Permanent Color Band.

APPLICATIONS:

- Switching power converters in power supply circuits
- Ideal for telecommunication and RF applications

STANDARD SPECIFICATIONS:

PARAMETERS	
ABRACON P/N:	AIAS-03
Operating temperature:	-55°C ~ +105 °C
Storage temperature:	-40°C to + 125°C

Part No. AIAS-03- Inductance Code	L(μ H)	Tolerance	Q (min)	L, Q Test Freq.	SRF(MHz)	DCR(Ω)	I _{SAT} (mA)
				(MHz)			
AIAS-03-R10	0.10	K	50	25	250	0.025	1790
AIAS-03-R12	0.12	K	51	25	250	0.340	1530
AIAS-03-R15	0.15	K	51	25	250	0.037	1470
AIAS-03-R18	0.18	K	50	25	250	0.047	1300
AIAS-03-R22	0.22	K	49	25	250	0.067	1100
AIAS-03-R27	0.27	K	47	25	250	0.11	855
AIAS-03-R33	0.33	K	46	25	250	0.13	780
AIAS-03-R39	0.39	K	44	25	250	0.18	670
AIAS-03-R47	0.47	K	44	25	235	0.25	565
AIAS-03-R56	0.56	K	43	25	210	0.33	490
AIAS-03-R68	0.68	K	42	25	190	0.45	420
AIAS-03-R82	0.82	K	40	25	180	0.59	370
AIAS-03-1R0	1.0	K	40	25	140	0.07	1070
AIAS-03-1R2	1.2	K	44	7.9	130	0.10	895
AIAS-03-1R5	1.5	K	44	7.9	115	0.12	815
AIAS-03-1R8	1.8	K	44	7.9	105	0.14	775
AIAS-03-2R2	2.2	K	44	7.9	100	0.19	650
AIAS-03-2R7	2.7	K	44	7.9	92	0.28	535
AIAS-03-3R3	3.3	K	44	7.9	85	0.35	480
AIAS-03-3R9	3.9	K	44	7.9	75	0.40	450
AIAS-03-4R7	4.7	K	44	7.9	70	0.55	380
AIAS-03-5R6	5.6	K	44	7.9	65	0.72	335
AIAS-03-6R8	6.8	K	50	7.9	55	1.02	280
AIAS-03-8R2	8.2	K	50	7.9	50	1.32	250
AIAS-03-100	10	K	50	7.9	46	1.62	220
AIAS-03-120	12	K	55	2.5	44	2.00	200
AIAS-03-150	15	K	45	2.5	49	0.80	250
AIAS-03-180	18	K	45	2.5	45	0.89	235
AIAS-03-220	22	K	45	2.5	41	0.96	220
AIAS-03-270	27	K	45	2.5	38	1.19	200
AIAS-03-330	33	K	45	2.5	34	1.37	190
AIAS-03-390	39	K	50	2.5	29	1.93	180
AIAS-03-470	47	K	50	2.5	27	2.11	175
AIAS-03-560	56	K	40	2.5	25	2.23	160
AIAS-03-680	68	K	50	2.5	21	2.70	150
AIAS-03-820	82	K	50	2.5	10.5	2.44	140



Shielded Axial Inductor

AIAS-03

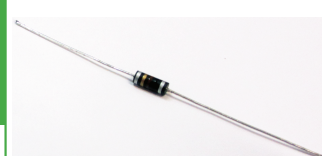

10.4 x ϕ 4.11 mm

Part No. AIAS-03- Inductance Code	L(μ H)	Tolerance	Q (min)	L, Q Test Freq.	SRF(MHz)	DCR(Ω)	I _{SAT} (mA)
				(MHz)	(min)	(max)	(max)
AIAS-03-101	100	J, K	50	2.5	10.0	3.12	120
AIAS-03-121	120	J, K	55	0.79	9.7	3.60	95
AIAS-03-151	150	J, K	55	0.79	8.5	4.10	90
AIAS-03-181	180	J, K	55	0.79	8.0	4.40	85
AIAS-03-221	220	J, K	55	0.79	7.5	5.0	80
AIAS-03-271	270	J, K	55	0.79	7.0	5.8	70
AIAS-03-331	330	J, K	55	0.79	6.5	6.4	65
AIAS-03-391	390	J, K	60	0.79	6.2	7.4	60
AIAS-03-471	470	J, K	60	0.79	5.7	9.5	58
AIAS-03-561	560	J, K	60	0.79	4.7	10.5	55
AIAS-03-681	680	J, K	60	0.79	4.5	11.8	50
AIAS-03-821	820	J, K	57	0.79	4.2	13.0	45
AIAS-03-102	1000	J, K	65	0.79	3.8	17.5	40
AIAS-03-122	1200	J, K	45	0.25	1.5	22.1	35
AIAS-03-152	1500	J, K	45	0.25	1.2	26.5	33
AIAS-03-182	1800	J, K	45	0.25	1.0	29.9	30
AIAS-03-222	2200	J, K	45	0.25	0.97	33.8	27
AIAS-03-272	2700	J, K	45	0.25	0.92	47.3	25
AIAS-03-332	3300	J, K	45	0.25	0.84	53.0	22
AIAS-03-392	3900	J, K	45	0.25	0.8	73.8	20
AIAS-03-472	4700	J, K	45	0.25	0.74	81.6	19
AIAS-03-562	5600	J, K	44	0.25	0.73	98.9	17
AIAS-03-682	6800	J, K	40	0.25	0.66	111	16
AIAS-03-822	8200	J, K	40	0.25	0.54	119	15
AIAS-03-103	10000	J, K	40	0.25	0.47	137	14
AIAS-03-123	12000	J, K	30	0.079	0.33	143	13
AIAS-03-153	15000	J, K	30	0.079	0.29	157	12
AIAS-03-183	18000	J, K	30	0.079	0.28	175	10
AIAS-03-223	22000	J, K	27	0.079	0.25	274	9
AIAS-03-273	27000	J, K	27	0.079	0.21	308	8
AIAS-03-333	33000	J, K	27	0.079	0.19	343	7.5
AIAS-03-393	39000	J, K	27	0.079	0.17	376	6
AIAS-03-473	47000	J, K	23	0.079	0.16	473	5.5
AIAS-03-563	56000	J, K	23	0.079	0.14	512	5
AIAS-03-683	68000	J, K	23	0.079	0.13	580	4
AIAS-03-823	82000	J, K	21	0.079	0.12	618	3.5
AIAS-03-104	100000	J, K	18	0.079	0.11	678	3

Test Conditions

1. **L & Q:** HP 4342A
2. **I_{sat}** : CH-301 current source & LCR meter. Based on the inductance change within 10% of initial value
3. **RDC** : CH-301 current source & LCR meter
4. **SRF** : HP-4191A .HP-4291B

ABRACON IS
ISO 9001:2008
CERTIFIED



Visit www.abracon.com for Terms & Conditions of Sale **Revised: 12.21.12**
30332 Esperanza, Rancho Santa Margarita, California 92688
tel 949-546-8000 | fax 949-546-8001 | www.abracon.com

Shielded Axial Inductor

AIAS-03



RoHS
Compliant

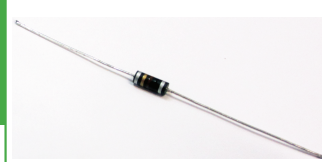

10.4 x ϕ 4.11 mm

PART NUMBER IDENTIFICATION:

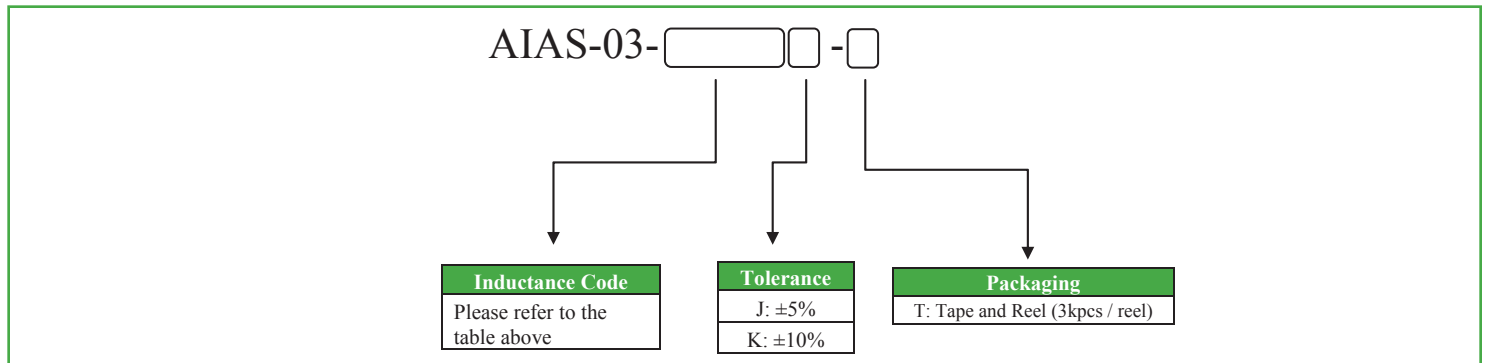

OUTLINE DIMENSIONS:

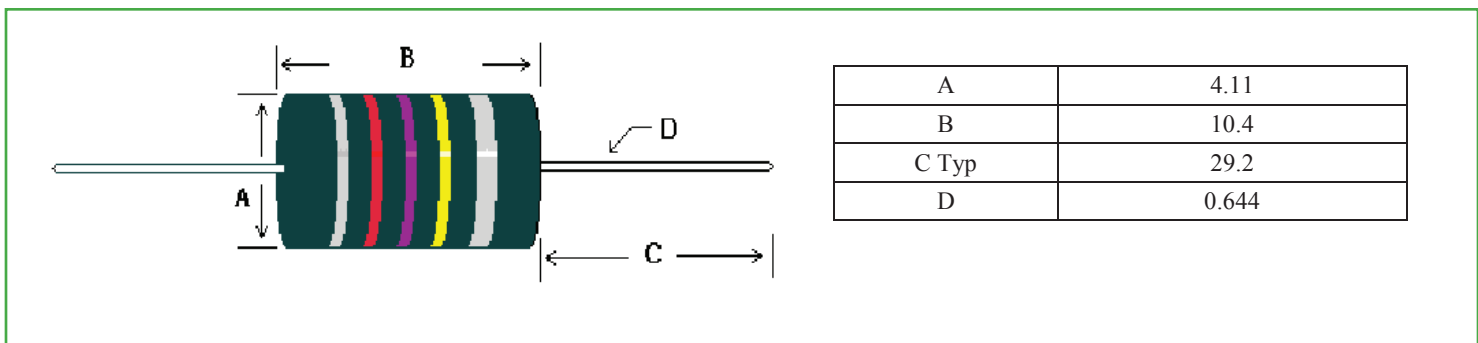

TAPE & REEL:

Packing (3,000pcs / Reel)

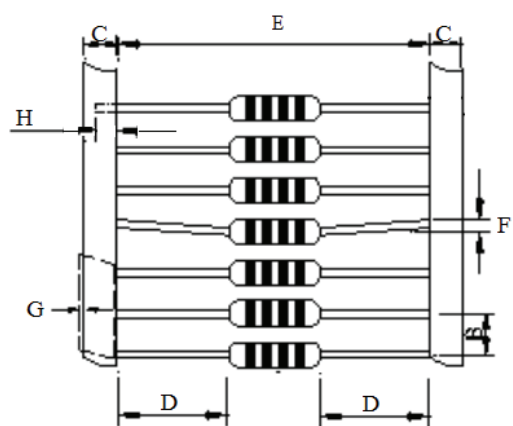

B	5+/-0.5
C	6+/-1.0
D	19 min
E	52+/-1.5mm
F	1.20 max
G	0.5 max
H	3.2 min

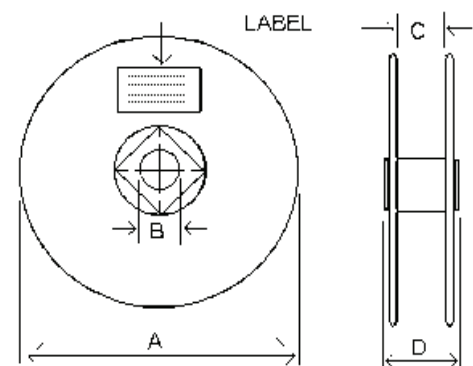

A	357+/-2
B	17+/-2
C	66+/-2
D	80+/-2

ATTENTION: Abracon Corporation's products are COTS – Commercial-Off-The-Shelf products; suitable for Commercial, Industrial and, where designated, Automotive Applications. Abracon's products are not specifically designed for Military, Aviation, Aerospace, Life-dependant Medical applications or any application requiring high reliability where component failure could result in loss of life and/or property. For applications requiring high reliability and/or presenting an extreme operating environment, written consent and authorization from Abracon Corporation is required. Please contact Abracon Corporation for more information.

ABRACON IS
ISO 9001:2008
CERTIFIED



Visit www.abracon.com for Terms & Conditions of Sale
30332 Esperanza, Rancho Santa Margarita, California 92688
tel 949-546-8000 | fax 949-546-8001 | www.abracon.com

Revised: 12.21.12