

BTA15

Discrete Triacs(Isolated)

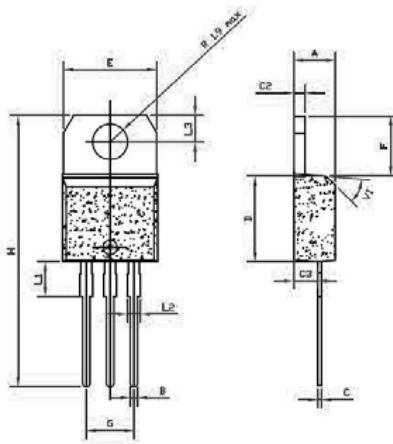
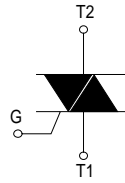

Ref.	Dimensions					
	Millimeters			Inches		
	Min.	Typ.	Max.	Min.	Typ.	Max.
A	4.4		4.6	0.173		1.181
B	0.61		0.88	0.024		0.034
C	0.46		0.70	0.018		0.027
C2	1.23		1.32	0.048		0.051
C3	2.4		2.72	0.094		0.107
D	8.6		9.7	0.338		0.382
E	9.8		10.4	0.386		0.409
F	6.2		6.6	0.244		0.259
G	4.8		5.4	0.189		0.213
H	28.0		29.8	11.0		11.7
L1		3.75			0.147	
L2	1.14		1.7	0.044		0.066
L3	2.65		2.95	0.104		0.116
V1		40°			40°	

	$V_{DRM/RRM}$	$V_{DSM/RSM}$
	V	V
BTA15-200	200	300
BTA15-400	400	500
BTA15-600	600	700
BTA15-800	800	900
BTA15-1000	1000	1100
BTA15-1200	1200	1300

ABSOLUTE MAXIMUM RATINGS

Symbol	Parameter			Value	Unit
$I_T(RMS)$	RMS on-state current (full sine wave)	TO-220AB	$T_c = 100^\circ C$	15	A
I_{TSM}	Non repetitive surge peak on-state current (full cycle, T_j initial = $25^\circ C$)	F = 60 Hz	t = 16.7 ms	160	A
		F = 50 Hz	t = 20 ms	168	
I_t^2	I_t^2 Value for fusing	tp = 10 ms		144	A ² s
di/dt	Critical rate of rise of on-state current $I_G = 2 \times I_{GT}$, tr ≤ 100 ns	F = 120 Hz	$T_j = 125^\circ C$	50	A/μs
V_{DSM}/V_{RSM}	Non repetitive surge peak off-state voltage	tp = 10 ms	$T_j = 25^\circ C$	$V_{DRM}/V_{RRM} + 100$	V
I_{GM}	Peak gate current	tp = 20 μs	$T_j = 125^\circ C$	4	A
PG(AV)	Average gate power dissipation	$T_j = 125^\circ C$		1	W
T_{stg} T_j	Storage junction temperature range Operating junction temperature range			- 40 to + 150 - 40 to + 125	°C

ELECTRICAL CHARACTERISTICS ($T_j = 25^\circ C$, unless otherwise specified)

■ SNUBBE RL ES and LOGIC LEVEL(3 Quadrants)

Symbol	Test Conditions	Quadrant	BTA		Unit	
			CW	BW		
I_{GT}	$V_D = 12 V$ $R_L = 33 \Omega$	I - II - III	MAX.	35	50	mA
V_{GT}		I - II - III	MAX.	1.3		
V_{GD}	$V_D = V_{DRM}$ $R_L = 3.3 k\Omega$ $T_j = 125^\circ C$	I - II - III	MIN.	0.2		V
I_H	$I_T = 500 mA$		MAX.	35	50	mA
I_L	$I_G = 1.2 I_{GT}$	I - III	MAX.	50	70	mA
		II		60	80	
dV/dt	$V_D = 67\% V_{DRM}$ gate open $T_j = 125^\circ C$		MIN.	500	1000	V/μs
(di/dt)c	Without snubber $T_j = 125^\circ C$		MIN.	8.5	14	A/ms

BTA15

Discrete Triacs(Isolated)

■ STANDARD (4 Quadrants)

Symbol	Test Conditions	Quadrant		Value	Unit
I_{GT}	$V_D = 12\text{ V}$ $R_L = 33\ \Omega$	I - II - III IV	MAX.	50 100	mA
V_{GT}		ALL	MAX.	1.3	V
V_{GD}	$V_D = V_{DRM}$ $R_L = 3.3\ \Omega$ $T_j = 125^\circ\text{C}$	ALL	MIN.	0.2	V
I_H	$I_T = 500\text{ mA}$		MAX.	50	mA
I_L	$I_G = 1.2 I_{GT}$	I - III - IV	MAX.	60	mA
		II		120	
dV/dt	$V_D = 67\% V_{DRM}$ gate open $T_j = 125^\circ\text{C}$		MIN.	400	V/ μs
(dV/dt) _c	(dI/dt) _c = 7A/ms $T_j = 125^\circ\text{C}$		MIN.	10	V/ μs

STATIC CHARACTERISTICS

Symbol	Test Conditions			Value	Unit
V_{TM}	$I_{TM} = 15\text{ A}$ $t_p = 380\ \mu\text{s}$	$T_j = 25^\circ\text{C}$	MAX.	1.55	V
V_{to}	Threshold voltage	$T_j = 125^\circ\text{C}$	MAX.	0.85	V
R_d	Dynamic resistance	$T_j = 125^\circ\text{C}$	MAX.	60	m Ω
I_{DRM}	$V_{DRM} = V_{RRM}$	$T_j = 25^\circ\text{C}$	MAX.	5	μA
I_{RRM}		$T_j = 125^\circ\text{C}$		1	mA

THERMAL RESISTANCES

Symbol	Parameter	Value	Unit
$R_{th(j-c)}$	Junction to case (AC)	1.2	$^\circ\text{C/W}$
$R_{th(j-a)}$	Junction to ambient	60	$^\circ\text{C/W}$

PRODUCT SELECTOR

Part Number	Voltage (xxx)		Sensitivity	Type	Package
	200 V	~ 1800 V			
BTA15	X	X	50 mA	Standard	TO-220AB

OTHER INFORMATION

Part Number	Marking	Weight	Base quantity	Packing mode
BTA15	BTA15	2 g	250	Bulk

BTA15

Discrete Triacs(Isolated)

Fig. 1: Maximum power dissipation versus RMS on-state current (full cycle).

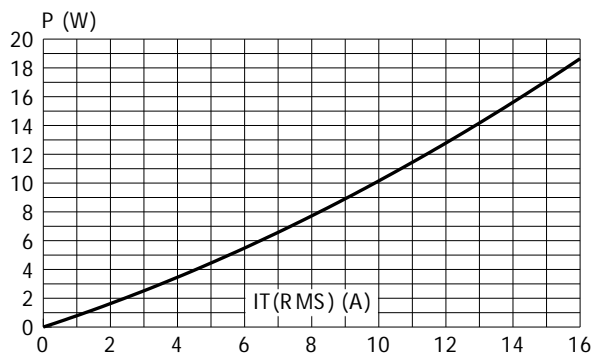

Fig. 3: Relative variation of thermal impedance versus pulse duration.

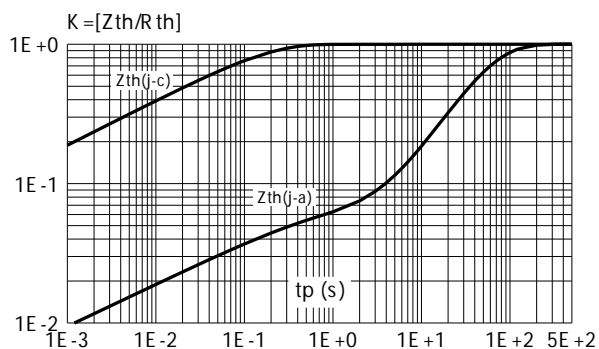

Fig. 5: Surge peak on-state current versus number of cycles.

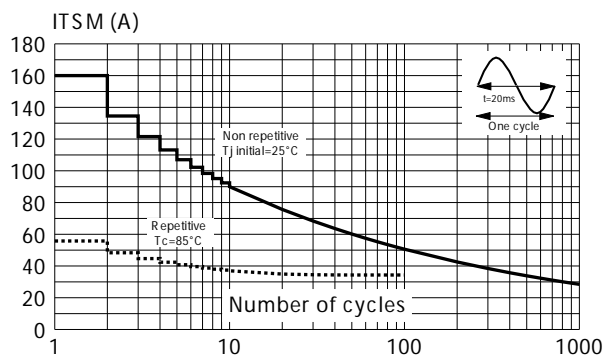

Fig. 2-1: RMS on-state current versus case temperature (full cycle).

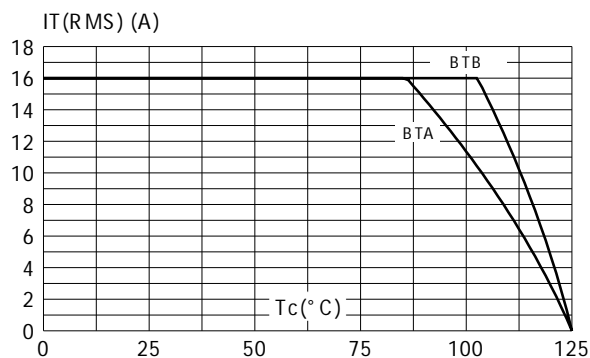
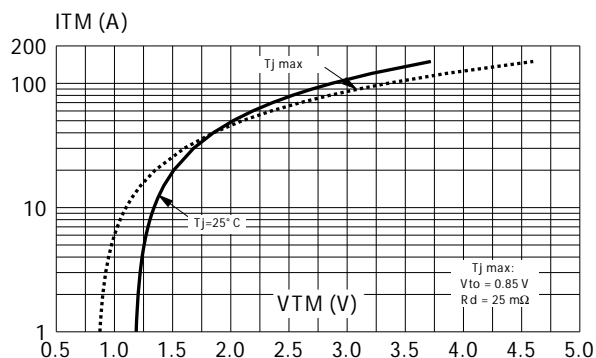

Fig. 4: On-state characteristics (maximum values)



BTA15

Discrete Triacs(Isolated)

Fig. 6: Non-repetitive surge peak on-state current for a sinusoidal pulse with width $t_p < 10\text{ms}$, and corresponding value of I^2t .

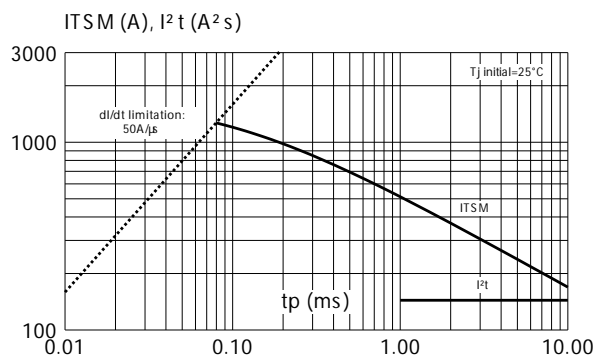

Fig. 8: Relative variation of critical rate of decrease of main current versus $(dV/dt)_c$ (typical values).

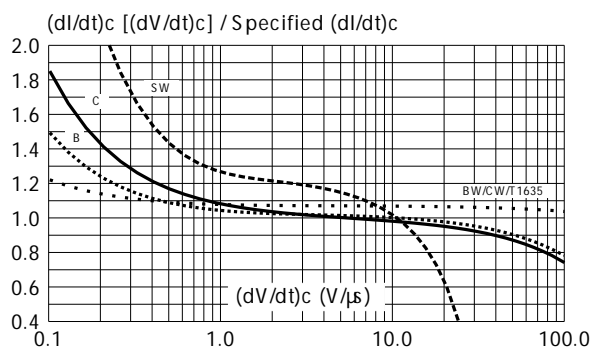

Fig. 7: Relative variation of gate trigger current, holding current and latching current versus junction temperature (typical values).

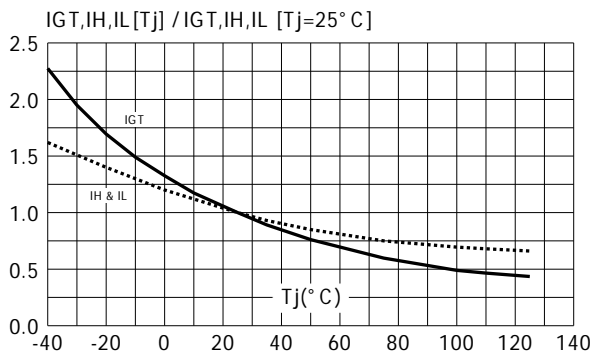

Fig. 9: Relative variation of critical rate of decrease of main current versus junction temperature.

