

### FEATURES

- Ideally suited for automatic insertion
- For switching and AF amplifier applications



### MAXIMUM RATINGS (Ta=25°C unless otherwise noted)

Symbol	Parameter	Value	Unit
V <sub>CB0</sub>	Collector-Base Voltage	BC846	80
		BC847	50
		BC848	30
V <sub>CEO</sub>	Collector-Emitter Voltage	BC846	65
		BC847	45
		BC848	30
V <sub>EBO</sub>	Emitter-Base Voltage	6	V
I <sub>C</sub>	Collector Current –Continuous	0.1	A
P <sub>C</sub>	Collector Power Dissipation	200	mW
R <sub>θJA</sub>	Thermal Resistance From Junction To Ambient	625	°C/W
T <sub>J</sub>	Junction Temperature	150	°C
T <sub>stg</sub>	Storage Temperature	-55~+150	°C

### DEVICE MARKING

BC846A=1A; BC846B=1B;  
BC847A=1E; BC847B=1F; BC847C=1G;  
BC848A=1J; BC848B=1K; BC848C=1L

**ELECTRICAL CHARACTERISTICS (T<sub>a</sub>=25°C unless otherwise specified)**

Parameter	Symbol	Test conditions	Min	Typ	Max	Unit
Collector-base breakdown voltage	BC846	I <sub>C</sub> = 10μA, I <sub>E</sub> =0	80			V
	BC847		50			
	BC848		30			
Collector-emitter breakdown voltage	BC846	I <sub>C</sub> = 10mA, I <sub>B</sub> =0	65			V
	BC847		45			
	BC848		30			
Emitter-base breakdown voltage	V <sub>EBO</sub>	I <sub>E</sub> = 10μA, I <sub>C</sub> =0	6			V
Collector cut-off current	BC846	V <sub>CB</sub> =70 V, I <sub>E</sub> =0			0.1	μA
	BC847	V <sub>CB</sub> =50 V, I <sub>E</sub> =0				
	BC848	V <sub>CB</sub> =30 V, I <sub>E</sub> =0				
Collector cut-off current	BC846	V <sub>CE</sub> =60 V, I <sub>B</sub> =0			0.1	μA
	BC847	V <sub>CE</sub> =45 V, I <sub>B</sub> =0				
	BC848	V <sub>CE</sub> =30 V, I <sub>B</sub> =0				
Emitter cut-off current	I <sub>EBO</sub>	V <sub>EB</sub> =5 V, I <sub>C</sub> =0			0.1	μA
DC current gain	BC846A,847A,848A	V <sub>CE</sub> = 5V, I <sub>C</sub> = 2mA	110		220	
	BC846B,847B,848B		200		450	
	BC847C,BC848C		420		800	
Collector-emitter saturation voltage	V <sub>CE(sat)</sub>	I <sub>C</sub> =100mA, I <sub>B</sub> = 5mA			0.5	V
Base-emitter saturation voltage	V <sub>BE(sat)</sub>	I <sub>C</sub> =100mA, I <sub>B</sub> = 5mA			1.1	V
Transition frequency	f <sub>T</sub>	V <sub>CE</sub> = 5 V, I <sub>C</sub> = 10mA f=100MHz	100			MHz
Collector output capacitance	C <sub>ob</sub>	V <sub>CB</sub> =10V,f=1MHz			4.5	pF

### Typical Characteristics

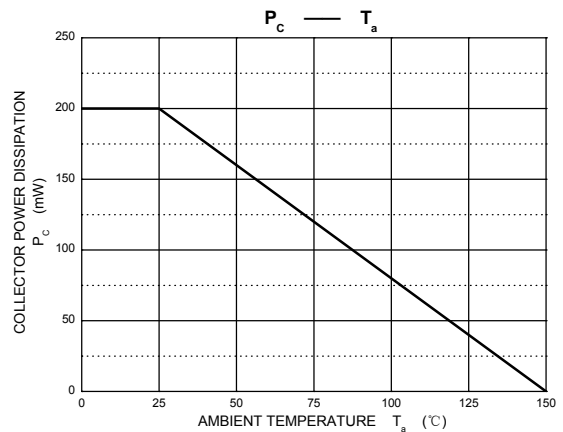
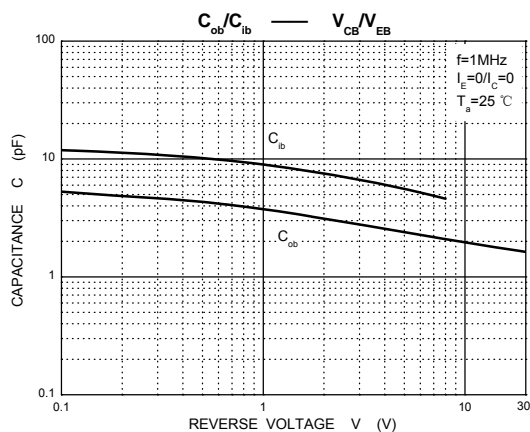
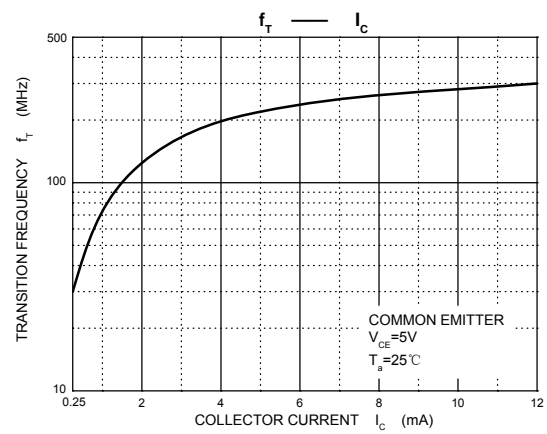
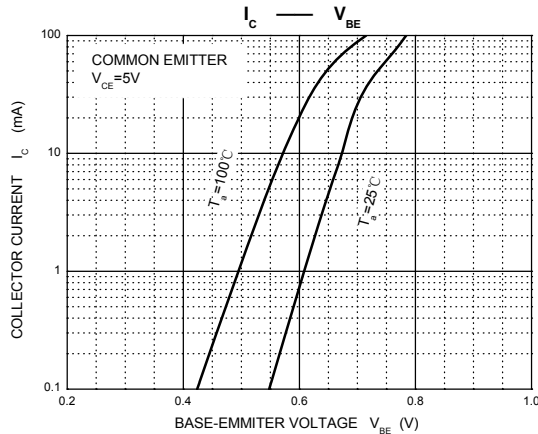
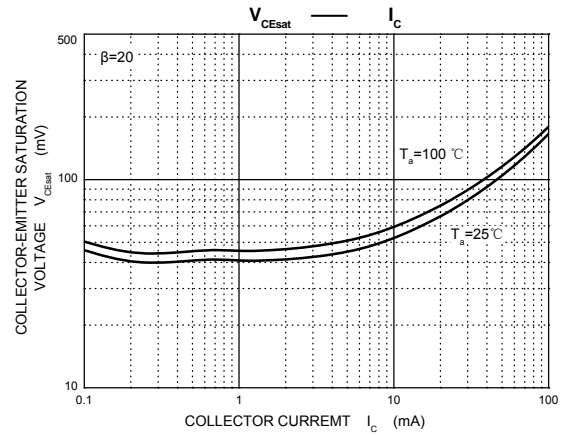
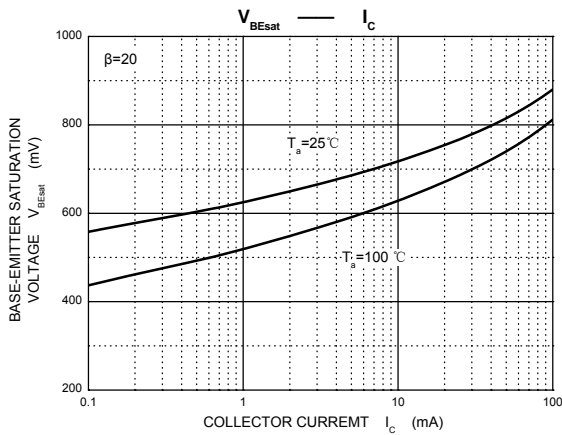
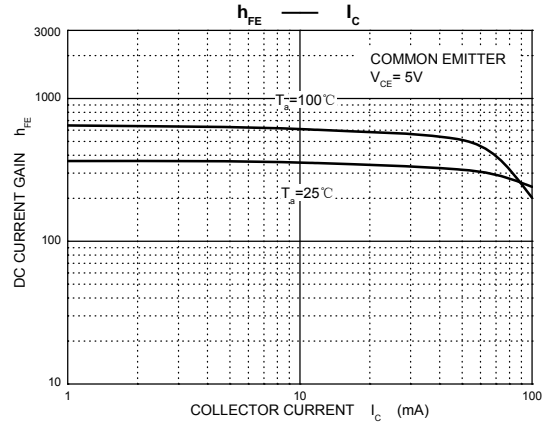
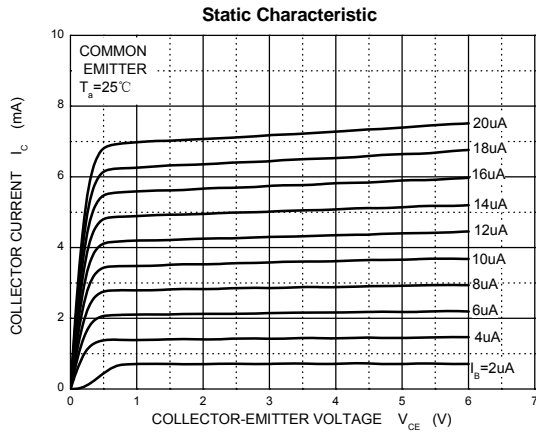

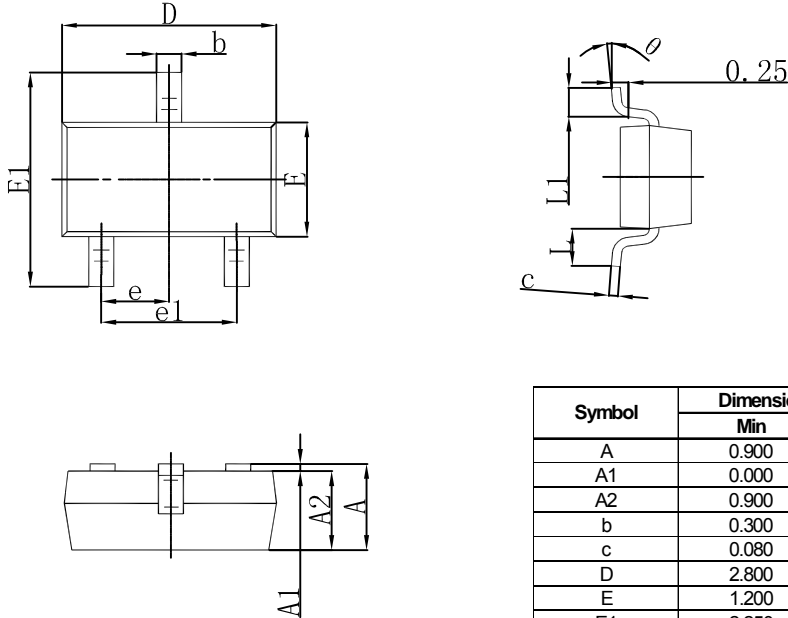
**SOT-23 Package Outline Dimensions**

Symbol	Dimensions In Millimeters		Dimensions In Inches	
	Min	Max	Min	Max
A	0.900	1.150	0.035	0.045
A1	0.000	0.100	0.000	0.004
A2	0.900	1.050	0.035	0.041
b	0.300	0.500	0.012	0.020
c	0.080	0.150	0.003	0.006
D	2.800	3.000	0.110	0.118
E	1.200	1.400	0.047	0.055
E1	2.250	2.550	0.089	0.100
e	0.950 TYP		0.037 TYP	
e1	1.800	2.000	0.071	0.079
L	0.550 REF		0.022 REF	
L1	0.300	0.500	0.012	0.020
θ	0°	8°	0°	6°

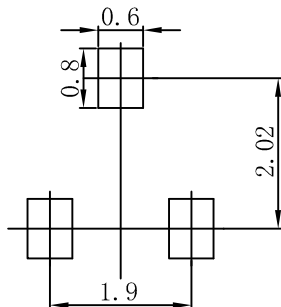
**SOT-23 Suggested Pad Layout**

**Note:**

1. Controlling dimension: in millimeters.
2. General tolerance:  $\pm 0.05\text{mm}$ .
3. The pad layout is for reference purposes only.