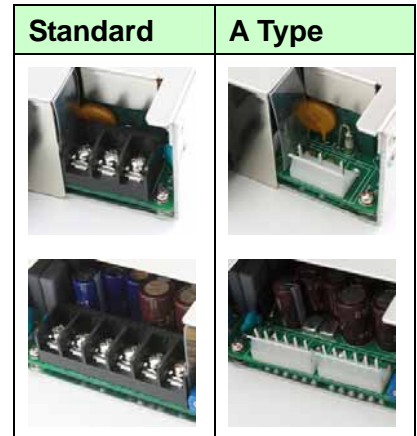

KEY FEATURES

- Enclosed Switching Power Supply
- Universal Input: 90-264 VAC
- Active P.F.C. Function, PF>0.95
- Cooling by Built-in DC FAN
- Protections: Over Load / Over Voltage /
Over Temperature / Short Circuit
All by Auto-recovery
- Built-in Remote ON/OFF Control
- Built-in Remote Sense Function
- Built-in DC OK Signal
- Stand by 5V @ 0.6A
- High Efficiency up to 92%
- Ultra Compact Size: 7.98 x 4.2 x 1.78 Inches
- 3-Years Product Warranty

ELECTRICAL SPECIFICATIONS

Model No.	AQFV480F-12S	AQFV480F-24S	AQFV480F-36S	AQFV480F-48S		
Max Output Wattage (W)	480W					
Input	Voltage		90-264 VAC or 120-370 VDC			
	Frequency (Hz)		47-63 Hz			
	Current (Full load)		< 5.5 A max. (115 VAC) / < 3.0 A max. (230 VAC)			
	Inrush Current (<2ms)		< 50 A max. (115 VAC) / < 70 A max. (230 VAC)			
	Leakage Current		< 0.5 mA max.(240VAC 63Hz)			
	Power Factor		PF>0.95 (115 VAC) / PF>0.90 (230 VAC) at Full Load			
Output	Voltage (V.DC.)	12V	24V	36V	48V	
	Trim	10.8 ~ 13.2V	21.6 ~ 26.4V	32.4 ~ 39.6V	43.2 ~ 50.4V	
	Voltage Accuracy	±2%				
	Current (18CFM FAN) (A) max	40	20	13.33	10	
	Line Regulation (LL-HL) (typ.)	±0.5%				
	Load Regulation (5-100%) (typ.)	±1%				
	Minimum Load	5%				
	Maximum Capacitive Load	180000 uF	75000 uF	50000 uF	25000 uF	
	Ripple & Noise (max.)	100mVp-p	200mVp-p	200mVp-p	300mVp-p	
	Efficiency (%)	Vin:115(V.AC)	85%	87%	89%	88%
		Vin:230(V.AC)	88%	90%	92%	91%
	Hold-up Time	10 ms min.				
	Switching Frequency	62.5 kHz ±10%				
Protection	Over Power Protection	Auto recovery				
	Over Voltage Protection	Auto recovery				
	Over Temperature	Auto recovery				
	Short Circuit Protection	Auto-recovery				
Isolation	Input-Output (V.AC)	3000V				
	Input-FG (V.AC)	1500V				
	Output-FG (V.AC)	500V				

1. All specifications valid at normal input voltage, full load and +25°C after warm-up time unless otherwise stated.

2. Ripple & Noise are measured at 20MHz of bandwidth with 0.1uF & 47uF parallel capacitor.

ELECTRICAL SPECIFICATIONS

Model No.	AQFV480F-12S	AQFV480F-24S	AQFV480F-36S	AQFV480F-48S	
Function	5V Stand by	5VSB: 5V@0.6A ; Tolerance $\pm 10\%$, Ripple & Noise: 100m Vp-p (max.)			
	DC OK Signal	Turn ON: 4~6V ; Turn OFF: 0~1V			
	Remote Control	+RC / -RC: Power ON=open ; Power OFF=short			
	FAN Control	12VDC / 0.5A max.			
Environment	Operating Temperature	-20°C...+70°C (with derating)			
	Storage Temperature	-25°C...+85°C			
	Temperature Coefficient	$\pm 0.03\%/^{\circ}\text{C}$ (0~50°C)			
	Humidity	95% RH			
	MTBF	>100,000 h @ 25°C (MIL-HDBK-217F)			
Physical	Vibration	10~500Hz, 2G 10min./1cycle, 60min. each along X, Y, Z axes.			
	Dimension (L x W x H)	7.98 x 4.2 x 1.78 Inches (202.8 x 106.5 x 45.0 mm) Tolerance ± 0.5 mm			
Safety	Weight	1050 g			
	Agency Approvals	UL60950-1, CE(Surge:4KV)			
EMC	EMI (Conducted & Radiated Emission)	EN 55022 class B			
	EMS (Noise Immunity)	EN 55024			

1. All specifications valid at normal input voltage, full load and +25°C after warm-up time unless otherwise stated.
2. Ripple & Noise are measured at 20MHz of bandwidth with 0.1uF & 47uF parallel capacitor.

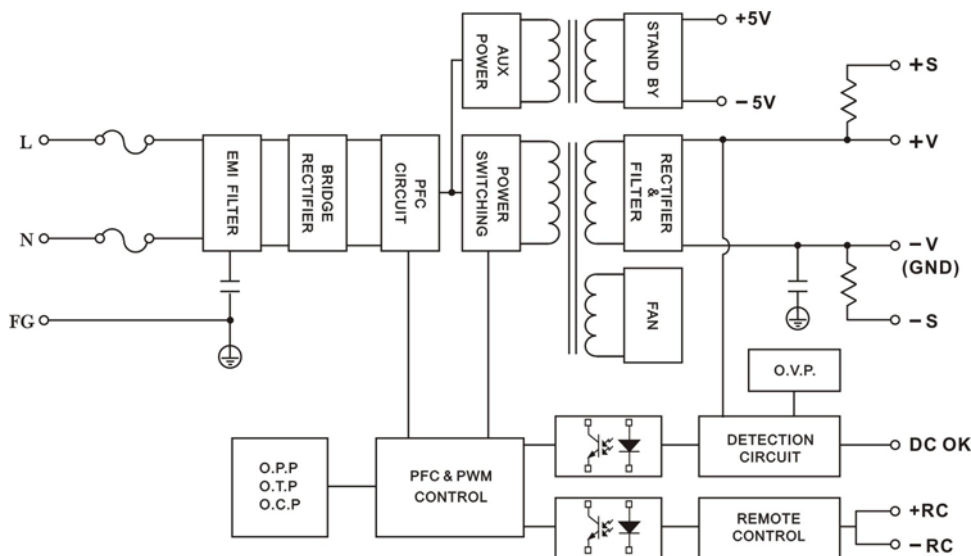
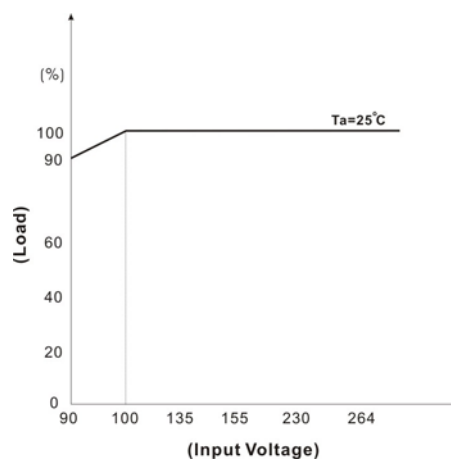
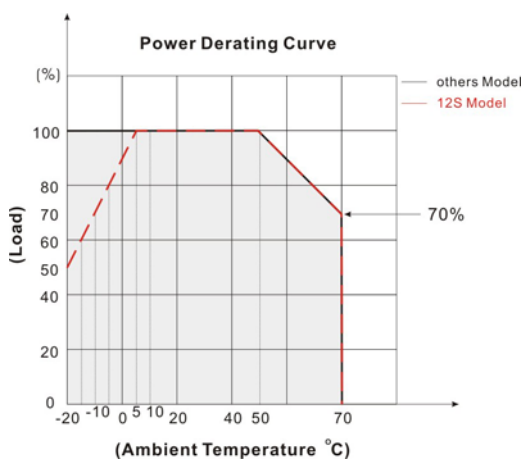
BLOCK DIAGRAM

DERATING

MECHANICAL DIMENSION
Standard

ASSEMBLY INSTRUCTIONS

*U Case T=2.0mm

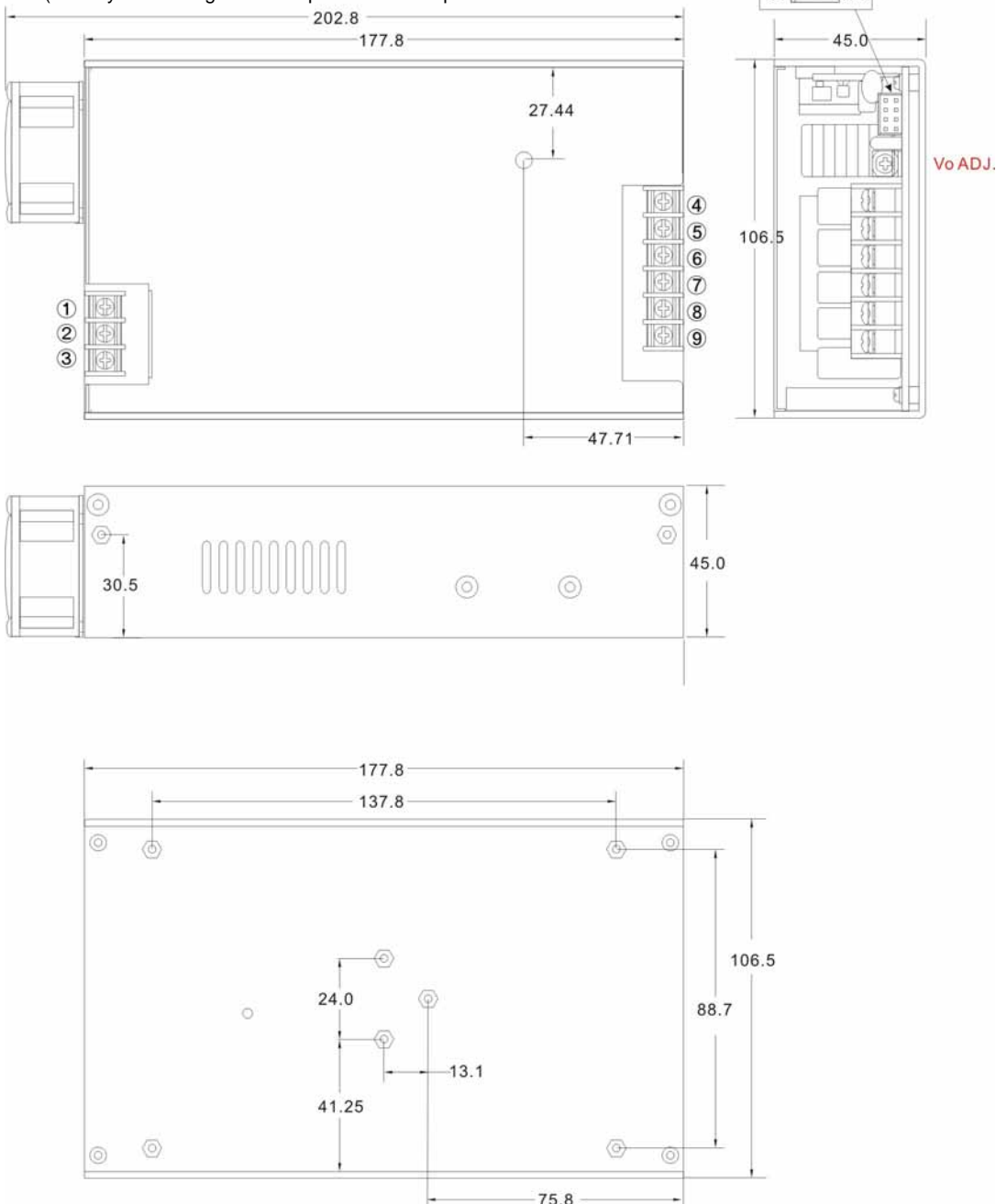
Customer screws into the length of the case no higher than 0.5mm
(Namely screw length for load plate thickness plus 2.5mm)

AC Input Terminal Pin

PIN#	SINGLE
1	AC IN (N)
2	AC IN (L)
3	⏏

DC Output Terminal Pin

PIN#	SINGLE
4~6	+DC OUT
7~9	-DC OUT

Connector Pin (CN4)

PIN#	SINGLE
C1	+S
C2	-S
C3	+RC
C4	-RC
C5	DC-OK
C6	GND
C7	+5V SB
C8	-5V SB

MECHANICAL DIMENSION
A Type

ASSEMBLY INSTRUCTIONS

*U Case T=2.0mm

Customer screws into the length of the case no higher than 0.5mm
(Namely screw length for load plate thickness plus 2.5mm)

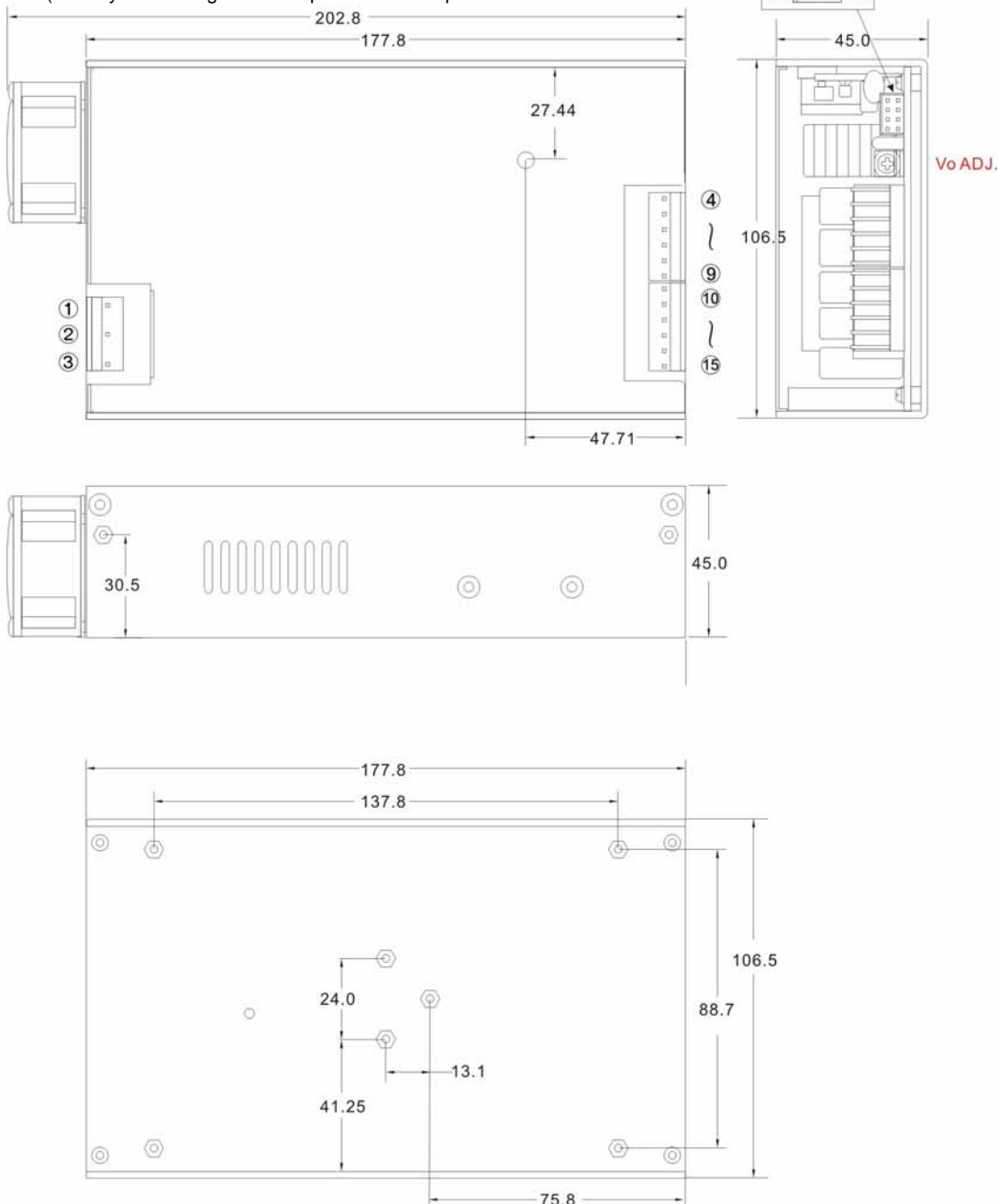
AC Input Terminal Pin

PIN#	SINGLE
1	AC IN (N)
2	AC IN (L)
3	⏏

DC Output Terminal Pin

PIN#	SINGLE
4~9	+DC OUT
10~15	-DC OUT

Connector Pin (CN4)

PIN#	SINGLE
C1	+S
C2	-S
C3	+RC
C4	-RC
C5	DC-OK
C6	GND
C7	+5V SB
C8	-5V SB

FUNCTION DESCRIPTION of CN4 :

Pin No.	Function	Description
C1	+S	Positive sensing. The +S signal should be connected to the positive terminal of the load. The +S and -S leads should be twisted in pair to minimize noise pick-up effect. The maximum line drop compensation is 0.5V. (max.)
C2	-S	Negative sensing. The -S signal should be connected to the negative terminal of the load. The -S and +S leads should be twisted in pair to minimize noise pick-up effect. The maximum line drop compensation is 0.5V. (max.)
C3	+RC	Turns the output on and off by electrical or dry contact between pin C4 (-RC), Short: Power OFF, Open: Power ON.
C4	-RC	Remote control ground.
C5	DC-OK	DC-OK Signal is a DC output, referenced to pinC6(DC-OK GND).
C6	GND	This pin connects to the negative terminal(-V). Return for DC-OK signal output.
C7	+5V SB	Stand by voltage output ground 4.5~5.5V, referenced to pin C8(-5V SB). The maximum load current is 0.6A.
C8	-5V SB	Stand by voltage output ground.

FUNCTION MANUAL :
1. Remote Sense

The remote sensing compensates voltage drop on the load wiring up to 0.5V. (max.)

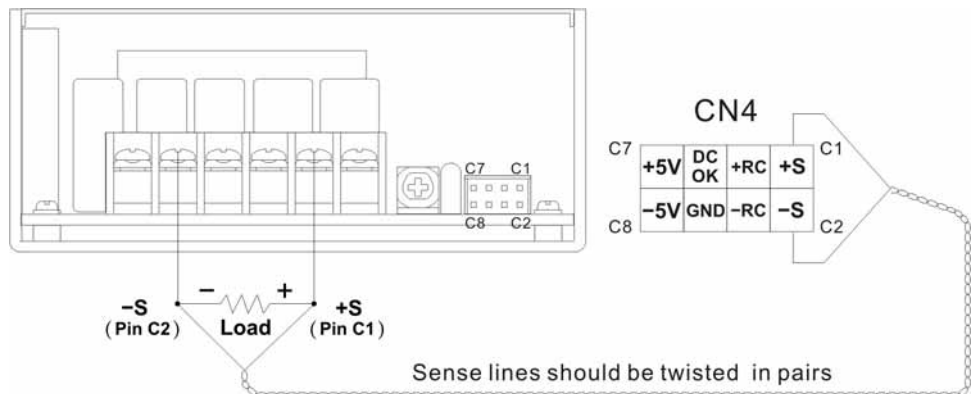

2. DC-OK Signal

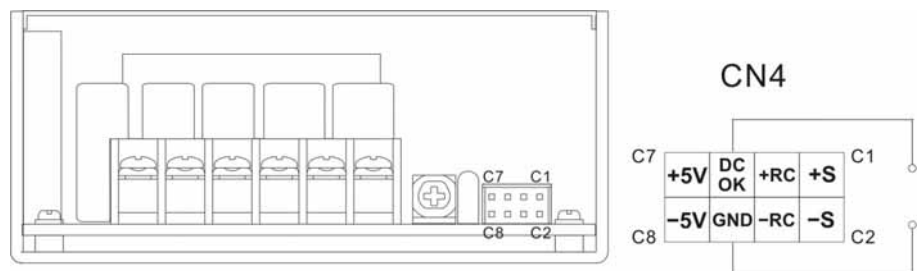
Between DC-OK(pinC5) and GND(pinC6)	Output Status
4~6V	ON
0~1V	OFF

3. Remote Control

It can be turned ON/OFF by using the "Remote Control" function.

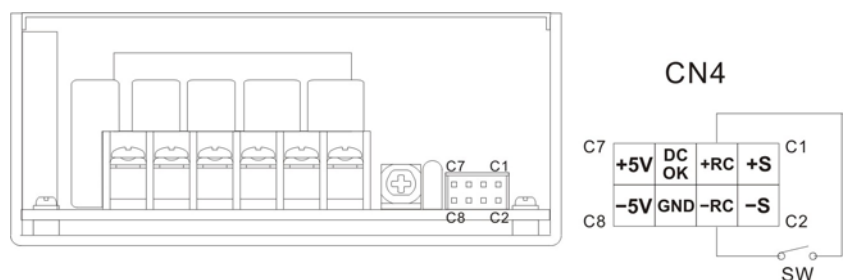
Between RC+(pinC3) and RC-(pinC4)	Output Status
SW ON (Short)	OFF
SW OFF (Open)	ON



EFFICIENCY VERSUS LOAD (with 18CFM FAN)
AQFV480F-12S
VIN VS Efficiency

Input Voltage (V)	90	115	180	230	264
Efficiency (%)	83.90	86.17	88.12	88.97	89.15

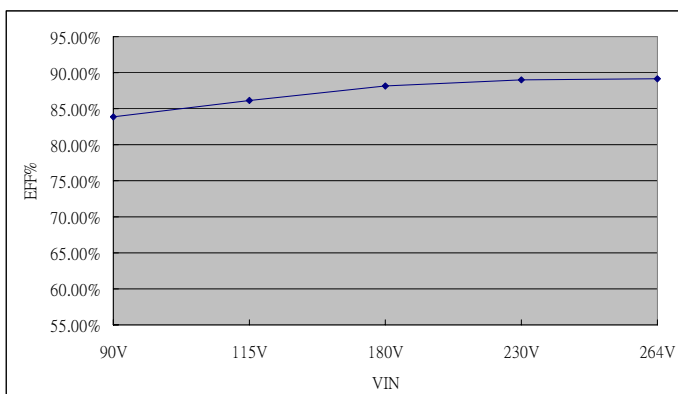
LOAD VS Efficiency

Load (%)	0	10	20	30	40	50
115V (%)	0	80.55	87.57	89.04	88.85	88.71
230V (%)	0	79.24	87.06	89.66	90.39	90.81
Load (%)	60	70	80	90	100	
115V (%)	88.59	88.16	87.53	86.93	86.17	
230V (%)	90.62	90.38	89.98	89.55	88.97	

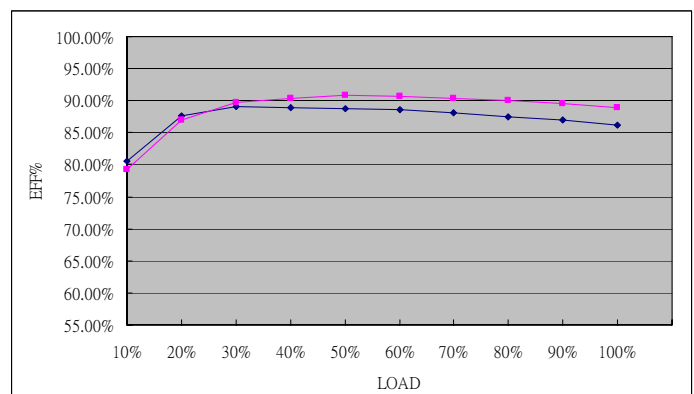
AQFV480F-24S
VIN VS Efficiency

Input Voltage (V)	90	115	180	230	264
Efficiency (%)	86.51	88.60	90.58	91.32	91.56

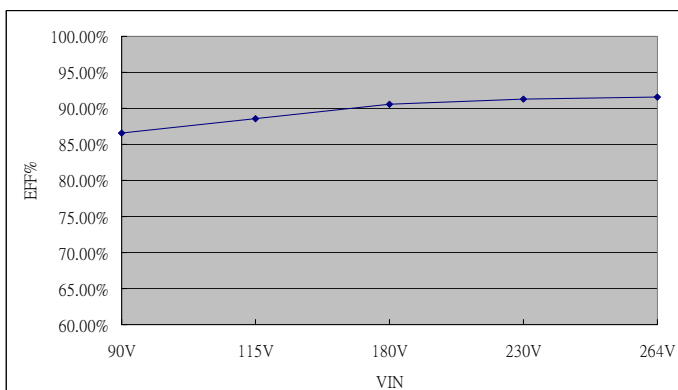

LOAD VS Efficiency

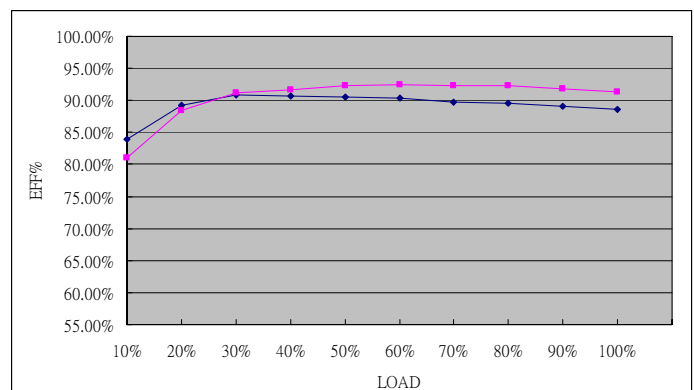
Load (%)	0	10	20	30	40	50
115V (%)	0	83.91	89.22	90.81	90.61	90.53
230V (%)	0	81.02	88.37	91.11	91.72	92.35
Load (%)	60	70	80	90	100	
115V (%)	90.36	89.66	89.56	89.10	88.60	
230V (%)	92.48	92.36	92.23	91.74	91.32	

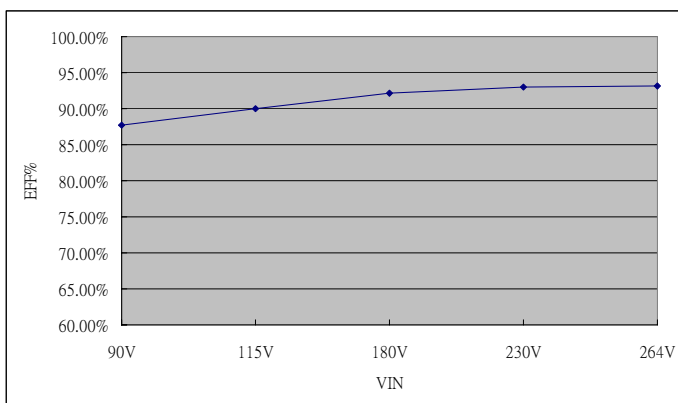

EFFICIENCY VERSUS LOAD (with 18CFM FAN)
AQFV480F-36S
VIN VS Efficiency

Input Voltage (V)	90	115	180	230	264
Efficiency (%)	87.75	89.98	92.19	92.96	93.21

LOAD VS Efficiency

Load (%)	0	10	20	30	40	50
115V (%)	0	81.77	87.84	90.61	90.36	90.80
230V (%)	0	78.91	87.02	90.20	91.32	92.36
Load (%)	60	70	80	90	100	
115V (%)	91.05	90.75	90.49	90.30	89.98	
230V (%)	92.80	93.04	92.80	93.03	92.96	

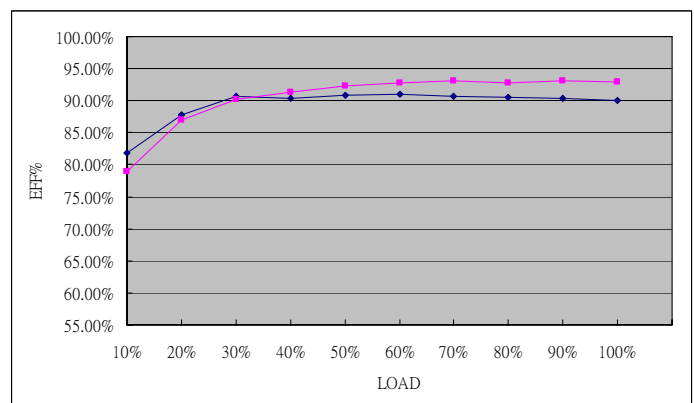
AQFV480F-48S
VIN VS Efficiency

Input Voltage (V)	90	115	180	230	264
Efficiency (%)	87.25	89.33	91.21	92.26	92.48

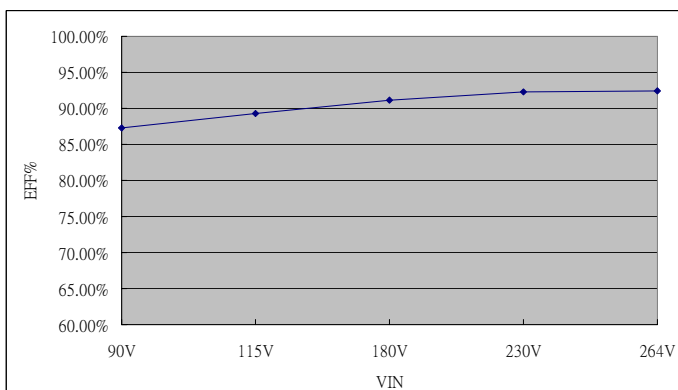
LOAD VS Efficiency

Load (%)	0	10	20	30	40	50
115V (%)	0	81.82	87.48	89.68	89.51	90.09
230V (%)	0	79.23	86.44	90.02	90.77	91.90
Load (%)	60	70	80	90	100	
115V (%)	89.92	90.07	89.75	89.78	89.33	
230V (%)	91.94	92.33	92.18	92.37	92.26	

