



Design Example Report

Title	<i>30W Multiple Output Power Supply using TOP245R</i>
Specification	Input: 90–264 V _{AC} Output: 1.8V/0.9A, 3.3V/1.3A, 5V/1.8A, 12V/50mA, 18V/0.6A, 23V/0.6A
Application	Set Top Box
Author	Power Integrations Applications Department
Document Number	DER-50
Date	April 20, 2005
Revision	1.0

Summary and Features

- Tight cross-regulation of $\pm 5\%$ on 3.3V and 5V.
- Small low cost EMI filter
- Highly integrated low cost solution
- Line feed-forward and over voltage protection

The products and applications illustrated herein (including circuits external to the products and transformer construction) may be covered by one or more U.S. and foreign patents or potentially by pending U.S. and foreign patent applications assigned to Power Integrations. A complete list of Power Integrations' patents may be found at www.powerint.com.

Table Of Contents

1	Introduction.....	3
2	Power Supply Specification.....	4
3	Schematic.....	5
4	Circuit Description	6
5	PCB Layout	8
6	Bill Of Materials	9
7	Transformer Specification.....	11
7.1	Electrical Diagram	11
7.2	Electrical Specifications.....	11
7.3	Materials.....	12
7.4	Transformer Build Diagram	13
7.5	Transformer Construction.....	14
8	Transformer Spreadsheets.....	15
9	Performance Data	18
9.1	Efficiency.....	18
9.2	No-load Input Power.....	18
9.3	Regulation	19
9.3.1	Line Regulation (Transformer Outputs only)	19
9.3.2	Cross Regulation (18V Output)	20
9.3.3	Cross Regulation (23V Output)	20
10	Waveforms.....	22
10.1	Drain Voltage and Current, Normal Operation	22
10.2	Output Voltage Start-up Profile (from Transformer Outputs only)	22
10.3	Drain Voltage and Current Start-up Profile.....	23
10.4	Load Transient Response	23
	Output Ripple Measurements	25
10.4.1	Ripple Measurement Technique	25
10.4.2	Measurement Results (Transformer Outputs only)	26
11	Conducted EMI	28
12	Revision History	30

Important Note:

Although this board is designed to satisfy safety isolation requirements, the engineering prototype has not been agency approved. Therefore, all testing should be performed using an isolation transformer to provide the AC input to the prototype board.

Design Reports contain a power supply design specification, schematic, bill of materials, and transformer documentation. Performance data and typical operation characteristics are included. Typically only a single prototype has been built.



1 Introduction

This document describes a 30W power supply prototype design using a TOP245R. The supply delivers 34W peak.

The document contains the power supply specification, schematic, bill of materials, transformer documentation, printed circuit layout, and performance data.

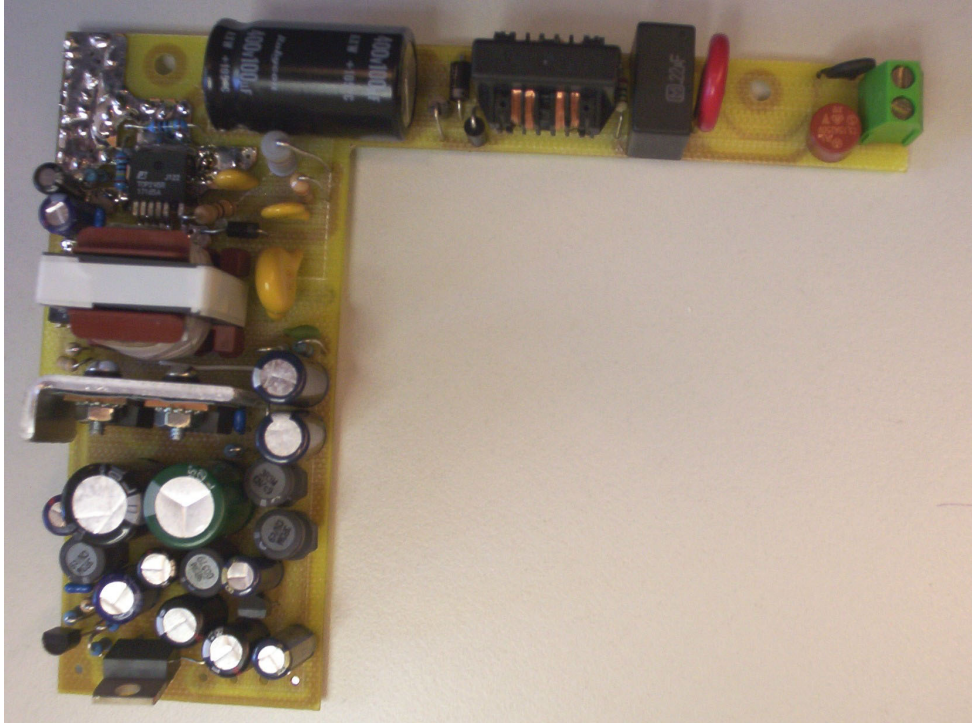

Figure 1 – Populated Circuit Board Photograph.

2 Power Supply Specification

Description	Symbol	Min	Typ	Max	Units	Comment
Input						
Voltage	V_{IN}	90		264	V_{AC}	
Frequency	f_{LINE}	47	50/60	64	Hz	
Outputs						
Output Voltage 1	V_{OUT1}	1.78	1.8	1.89	V	+5% / -1%
Output Ripple Voltage 1	$V_{RIPPLE1}$			27	mV	20 MHz Bandwidth
Output Current 1	I_{OUT1}	0.02	0.9		A	
Output Voltage 2	V_{OUT2}	3.17	3.3	3.43	V	± 4%
Output Ripple Voltage 2	$V_{RIPPLE2}$			50	mV	20 MHz Bandwidth
Output Current 2	I_{OUT2}	0.23	1.3		A	
Output Voltage 3	V_{OUT3}	4.75	5	5.25	V	±5%
Output Ripple Voltage 3	$V_{RIPPLE3}$			25	mV	20 MHz Bandwidth
Output Current 3	I_{OUT3}	0.55	1.8	2.3	A	
Output Voltage 4	V_{OUT4}	12.6	12	11.4	V	±5%
Output Ripple Voltage 4	$V_{RIPPLE4}$			100	mV	20 MHz Bandwidth
Output Current 4	I_{OUT4}	0	0.05	0.2	A	Dual to the following load (their total gives 1 A)
Output Voltage 5	V_{OUT5}	16.2	18	19.8	V	±10%
Output Ripple Voltage 5	$V_{RIPPLE5}$			72	mV	20 MHz Bandwidth
Output Current 5	I_{OUT5}	0	0.6		A	Dual to the following load (their total gives 0.6 A)
Output Voltage 6	V_{OUT6}	20.7	23	25.3	V	±10%
Output Ripple Voltage 6	$V_{RIPPLE6}$			92	mV	20 MHz Bandwidth
Output Current 6	I_{OUT6}	0	0.6		A	Dual to the previous load (their total gives 0.6 A)
Total Output Power						
Continuous Output Power	P_{OUT}		30		W	
Peak Output Power	P_{OUT_PEAK}		34		W	
Safety						Meets EN60065
Conducted EMI						Meets EN55013/20 Meets EN61000
Ambient Temperature	T_{AMB}	0		50	°C	Free convection, Sea level



3 Schematic

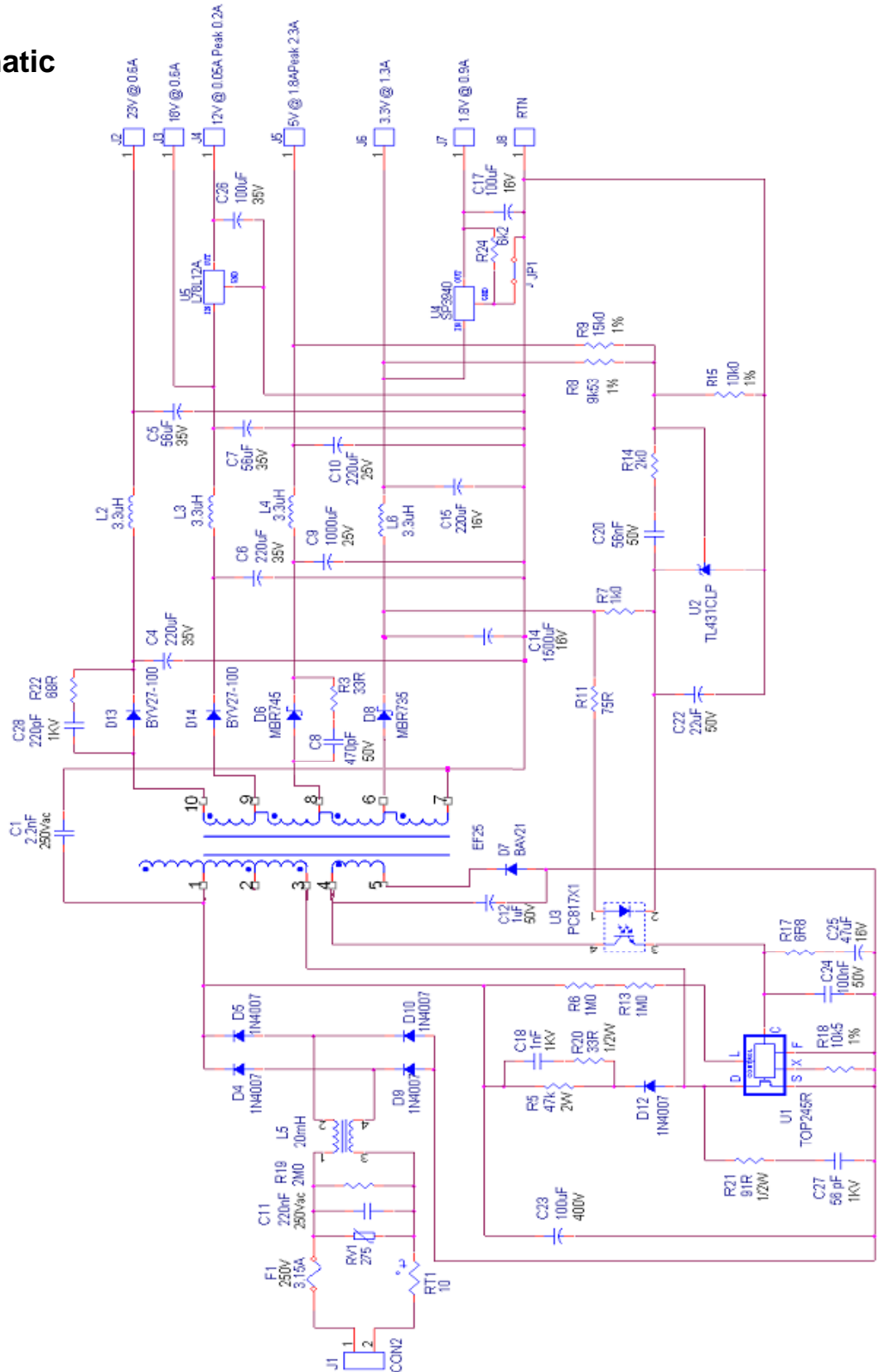

Figure 2 – Schematic.



4 Circuit Description

AC input power is rectified and filtered by D4, D5, D9, D10 and C23 to provide high voltage DC bus, which is applied to the primary of transformer T1. *TOP245R* DRAIN pin drives the other side of the transformer primary. Components C18, R20, R5 and D12 clamp the DRAIN voltage leakage inductance spike to below 700 V maximum rating of the *TOPSwitch*. The additional RC Snubber R21 and C27 is used to get better EMI results at higher frequencies.

Resistors R6 and R13 connected to the LINE SENSE pin (L) of the *TOPSwitch-GX* U1 are used to implement the built-in line voltage feed-forward and overvoltage protection features. The line feed forward feature modulates the control circuit of the *TOPSwitch-GX* with the AC line frequency ripple component of the input DC, reducing the line frequency ripple at the output of the supply. This simplifies the design of the power supply control loop by reducing the amount of control loop gain required at the line ripple frequency in order to meet output ripple specifications.

The overvoltage feature shuts down the power supply if the rectified DC bus voltage exceeds approximately 450V, set by the value of R6 and R13. The supply resumes operation when the bus voltage falls again below the overvoltage threshold value. This feature allows the supply to withstand severe line transients or extended surge conditions without damage.

Resistor R18 connected to the EXTERNAL CURRENT LIMIT pin (X) of U1 is used to externally program the device current limit to just above the peak primary current of the supply required for maximum peak load, minimum line voltage. This allows the transformer to be better optimized for the chosen operating conditions, while at the same time avoiding transformer core saturation during start-up or overload conditions.

D7 and C12 provide a DC voltage of approximately 15V to power the *TOP245R*. A relatively large value of C12 (1 μ F) is used to provide bias voltage ride-through during severe output load transients.

Capacitors C24 and C25 filters the internal bias supply of the *TOPSwitch-GX*, with C24 providing the necessary peak currents to drive the gate of its internal high voltage MOSFET. The larger capacitor C25 also determines the *TOPSwitch-GX* auto-restart frequency, and along with resistor R17, helps to compensate the power supply control loop.

Fine tuning and centering of the output voltage levels can be achieved by appropriate choice of diode (D2, D3, D6 and D8) for each output: by changing diode types, there is the option to change the voltage drop across it, and therefore the correspondent output voltage level.



Inductors L2, L3, L4, L6 are used along with capacitors C5, C7, C10, C15 to provide high frequency filtering for the outputs of the supply. These filters greatly reduce the switching frequency ripple and high frequency spike noise at the outputs of the supply.

A voltage divider consisting of resistors R8, R9 and R15 monitors the voltage on the 5V and 3.3V outputs. The resistor values are weighted so that the voltage feedback loop is controlled mostly by the 5V output (2/3), with some contribution from the 3.3V output (1/3). Sharing the voltage regulation control between the two outputs in this way improves the cross regulation for the 3.3V output at the expense of a slight change in the regulation of the 5V output. Resistor R11 is used to set the overall gain of the supply control loop, while R7 provides bias current for U2. R14 and C20 provide frequency compensation for U2 to help stabilize the power supply control loop. Capacitor C22 is used to provide open loop feedback through optocoupler ISO1 during start-up, which in conjunction with the built-in soft start-up feature of the *TOPSwitch*, completely controls the start-up drain current profile, preventing transformer saturation and output overshoot.

The approach used for this prototype is a multiple output flyback converter using the integrated functions of *TOPSwitch-GX* to minimize component count and system cost. In contrast to typical supplies, the design specification includes some extra requirements: -

- Regulation on the 18V and 23V rails must be maintained to within $\pm 10\%$ from zero load to full 0.6A load.

Due to leakage inductance, track resistance, winding resistance diode current/voltage characteristics, the 18V rail will most probably experience peak charging under zero load conditions. In order to maintain the $\pm 10\%$ regulation requirements on this rail, there are two possibilities:

1. Pre-load the 18V rail to such a level to keep within $\pm 10\%$ when the current drawn from this rail falls to zero.
2. Post-regulate the 18V rail to ensure tight regulation during the peak charging conditions.

The supply itself uses a TOP245R and EF25 core. Although the TOP244R could be used, the TOP245R was used to lower the system losses at low line input.

Front end protection is provided by F1, RT1 and RV1. C11 and L5 provide both common mode and differential mode conducted EMI filtering. The frequency jittering feature of *TOPSwitch-GX* has allowed for small EMI filter components.



5 PCB Layout

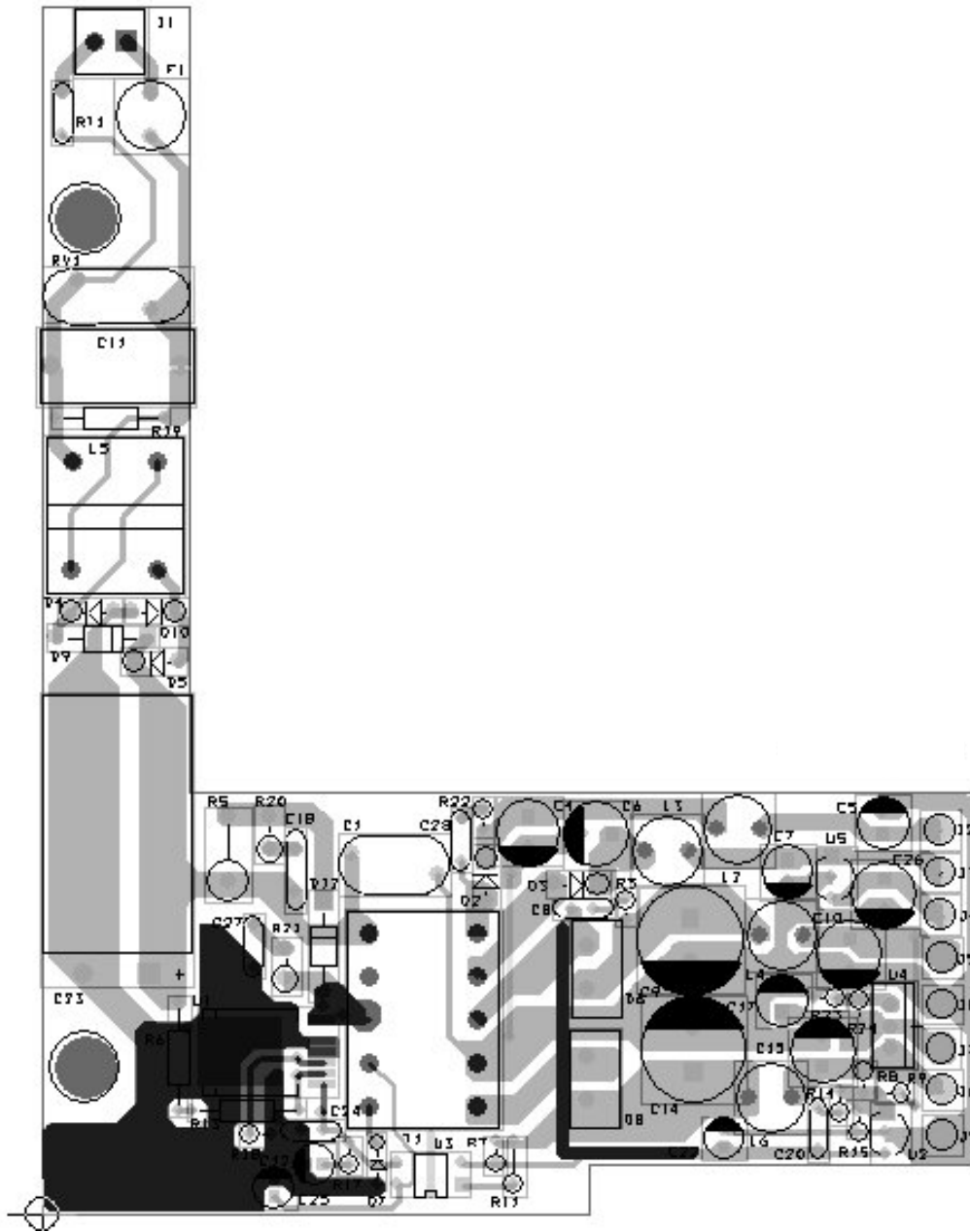

Figure 3 – Printed Circuit Layout.



6 Bill Of Materials

Item	Qty	Value	Description	Part Reference	Mfg
1	1	2.2nF	Cap,Cer,2.2nF, Y1, 250VAC	C1	
2	2	220uF	Cap,Al Elect,220uF,35V KZE Series	C4 C6	Nippon Chemi-Con
3	2	56uF	Cap,Al Elect,56uF,35VKZE Series	C5 C7	Nippon Chemi-Con
4	1	470pF	Cap,Cer, 470 pF, 50V, COG, 5%	C8	Panasonic
5	1	1000uF	Cap,Al Elect,1000uF,25V,KZE Series	C9	Nippon Chemi-Con
6	1	220uF	Cap,Al Elect,220uF,25V,KZE Series	C10	Nippon Chemi-Con
7	1	220nF	Cap,Metal Poly,0.22uF, X2,250Vac	C11	Panasonic
8	1	1uF	Cap,Al Elect,1uF,50V,LXZ Series	C12	Panasonic
9	1	1500uF	Cap,Al Elect,1500uF,16V,KZE Series	C14	Nippon Chemi-Con
10	1	220uF	Cap,Al Elect,220uF,16V,LXZ Series	C15	Nippon Chemi-Con
11	1	100uF	Cap,Al Elect,100uF,16V,LXZ Series	C17	Nippon Chemi-Con
12	1	1nF	Cap,Cer,1000 pF, 1000V,10%	C18	Panasonic
13	1	56nF	CAP 56000pF 50V CERM CHIP	C20	Panasonic
14	1	22uF	Cap,Al Elect,22uF,50V,LXZ Series,	C22	Nippon Chemi-Con
15	1	100uF	Cap,Al Elect,100uF,400V,TSED Series	C23	Panasonic
16	1	100nF	Cap,Cer, 0.10 uF, 50V, Z5U, 20%	C24	Panasonic
17	1	47uF	Cap,Al Elect,47uF,16V,LXZ Series	C25	Nippon Chemi-Con
18	1	100uF	Cap,Al Elect,100uF,35V,LXZ Series	C26	Nippon Chemi-Con
19	1	56 pF	Cap,Cer,56 pF, 1000V,SL/GP 5%	C27	Panasonic
20	1	220pF	Cap,Cer,220pF, 1000V, 10%	C28	NIC Components Corp
21	1	BYV-27-100	Rectifier Ultrafast 100V, 2A, SOD57	D2 D3	Philips
22	5	1N4007	Rectifier GPP 1000V 1A DO-41	D4 D5 D9 D10 D12	
23	1	MBR745	Diode Schottky 45V 7.5A TO-220AC	D6	
24	1	BAV21	Diode Fast Switch 250V 500MW DO35	D7	
25	1	MBR735	Diode Schottky 35V 7.5A TO-220AC	D8	
26	1	3.15A	FUSE T-LAG 3.15A, 250V,Slo-Blo IEC SHORT TR5	F1	Wickman
27	1	CON2	CONN HEADER 2POS(1 X 2) .156 VERT TIN	J1	Molex
28	7	23V @ 0.6A	Terminal,1Pin,18AWG	J2 J3 J4 J5 J6 J7 J8	
29	4	3.3uH	Inductor,3.3uH,2.66A	L2 L3 L4 L6	Toko
30	1	20mH	CHOKER,20mH,1.3A,SU9V-03050,TOKIN	L5	
31	1	33R	Res, 33, 1/4W, 5%, Carbon Film	R3	Yageo
32	1	47k	Res, 47K ,2W, 5%, Metal Film	R5	Yageo
33	2	1M0	Res, 1.0M, 1/4W, 5%, Carbon Film	R6 R13	Yageo
34	1	1k0	Res, 1.0K, 1/4W, 5%, Carbon Film	R7	Yageo
35	1	9k53	Res,9.51K, 1/4W, 1%, M-FILM	R8	Yageo
36	1	15k0	Res,15.0K, 1/4W, 1%, M-FILM	R9	Yageo
37	1	75R	Res, 75, 1/4W, 5%, Carbon Film	R11	Yageo
38	1	2k0	Res, 2.0K, 1/4W, 5%, Carbon Film	R14	Yageo
39	1	10k	Res,10.0K, 1/4W, 1%, M-FILM	R15	Yageo
40	1	6R8	Res, 6.8, 1/4W, 5%, Carbon Film	R17	Yageo
41	1	10k5	Res,10.5K, 1/4W, 1%, M-FILM	R18	Yageo
42	1	2M0	Res, 2.0M, 1/4W, 5%, Carbon Film	R19	Yageo
43	1	33R	Res, 33, 1/2W, 5%, Carbon Film	R20	Yageo



44	1	91R	Res, 91, 1/2W, 5%, Carbon Film	R21	Yageo
45	1	68R	Res, 68, 1/4W, 5%, Carbon Film	R22	Yageo
46	1		JUMPER	R23	Yageo
47	1	6k2	Res, 6.2K, 1/4W, 5%, Carbon Film	R24	Yageo
48	1	10	Thermistor,10 Ohms,1.7 A	RT1	THERMOMETRICS
49	1	275	VARISTOR 275V 75J 14MM RADIAL LA	RV1	Littlefuse
50	2	SCR_6-32	SCR,Phillips,6-32X1/4	SCREW1	SCREW2
51	1	EF25	BEF25_10P	T1	
52	1	TOP245R	IC,TOP245R,INT.	U1	Power Int.
53	1	TL431CLP	IC,TL431CLP, ADJ SHUNT REG TO-92	U2	TI
54	1	PC817X1	IC,PC817X1,PHOTOCOUPLER	U3	Sharp
55	1	SPX3940	LDO 1.8V 1A	U4	
56	1	L78L12A	Volt-Reg 12V, 0.1A	U5	TI



7 Transformer Specification

7.1 Electrical Diagram

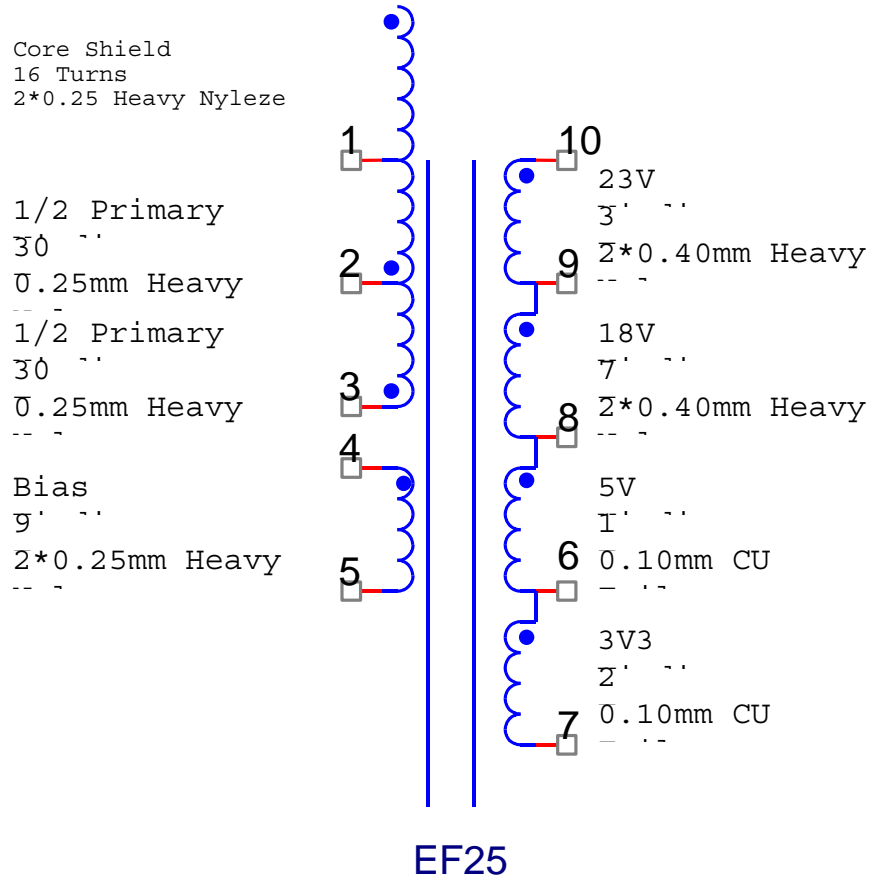

Figure 4 –Transformer Electrical Diagram

7.2 Electrical Specifications

Electrical Strength	1 second, 60 Hz, from Pins 1 - 3 to Pins 7 - 10	3000 VAC
Primary Inductance	Pins 1-3, all other windings open, measured at 100 kHz, 0.4 VRMS	504 μ H, -0/+20%
Primary Leakage Inductance	Pins 1-3, with Pins 7-10 shorted, measured at 100 kHz, 0.4 VRMS	20 μ H (Max.)



7.3 Materials

Item	Description
[1]	Core: PC40EF25, TDK or equivalent Gapped for AL of 140 nH/T ²
[2]	Bobbin: EF25 Vertical 10 pin
[3]	Magnet Wire: 0.25mm
[4]	Copper Foil: 10mm x 0.1mm
[5]	Magnet Wire: 0.40mm
[6]	Tape: 3M 1298 Polyester Film, 15 mm wide
[7]	Tape: 3M 1298 Polyester Film, 8 mm wide
[8]	Tape: 3M 44 Margin Tape, 3 mm wide
[9]	Varnish



7.4 Transformer Build Diagram

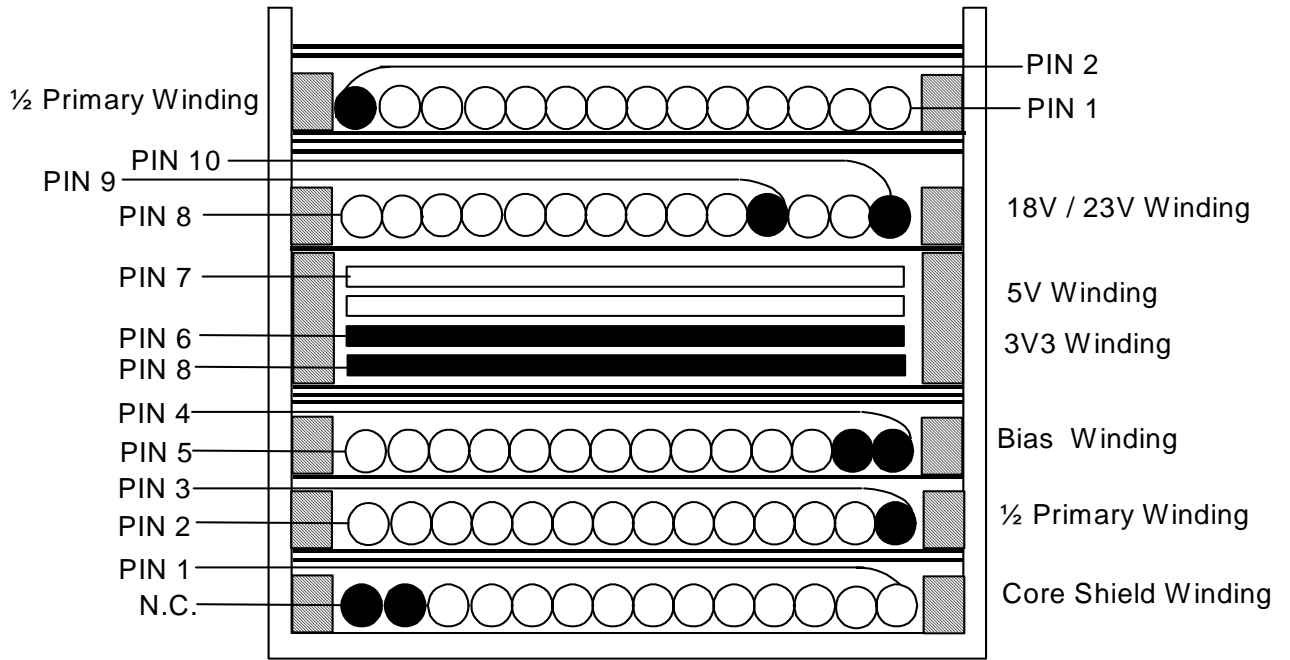
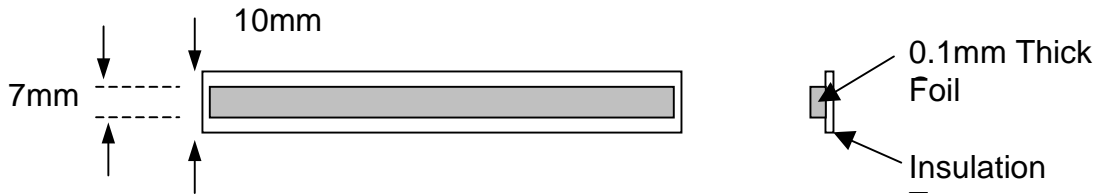

Figure 5 – Transformer Build Diagram.



7.5 Transformer Construction

Bobbin Preparation	Place 3mm of Margin tape on each side of the EF25 Bobbin.
Core Shield	Fix the bifilar item [3] to PIN 2. Wind 16 bifilar turns from left to right covering a single full layer. Finish winding at PIN 1. Unwrap the other end of the winding from PIN 2 and leave that end inside.
Tape	1 layer of item [6] for mechanical fixing.
½ Primary	Start at Pin 3. Wind 30 turns of item [3] in approximately 1 layer from right to left. Bring finish lead back to start. Finish on Pin 2.
Basic Insulation	1 layer of item [6] for basic insulation.
Bifilar Bias Winding	Starting at Pin 4, wind 9 bifilar turns of item [3] from right to left. Spread turns evenly across bobbin. Finish at Pin 5.
Insulation	Use 3 layers of item [6] for safety insulation.
3V3 and 5V Windings	Start at Pin 8. Wind 2 turns of copper foil [4]. Bring termination wire out onto pin 6. Continue with one further copper foil turn and finish with termination on pin 7.
Tape	1 layer of item [6] for mechanical fixing.
18V and 23V Windings	Start at Pin 10. Wind 3 turns of 2 parallel strands of item [5] from right to left. Terminate on pin 9. Continue with 7 further turns of 2 parallel strands of item [5]. Finish on pin 8.
½ Primary	Start at Pin 2. Wind 30 turns of item [3] in approximately 1 layer from left to right. Bring finish lead back to start. Finish on Pin 1.
Outer Wrap	Wrap windings with 2 layers of tape item [6].
Final Assembly	Assemble and secure core halves so that the tape wrapped E core is at the bottom of the transformer. Varnish impregnate (item [9]).



8 Transformer Spreadsheets

	INPUT	INFO	OUTPUT	UNIT
ENTER APPLICATION VARIABLES				
VACMIN	90			Volts
VACMAX	264			Volts
fL	50			Hertz
VO	3.3			Volts
PO	29.64			Watts
n	0.8			
Z	0.5			
VB	17			Volts
tC	3			mSeconds
CIN	100			uFarads
ENTER TOPSWITCH-GX VARIABLES				
TOP-GX	top245			Universal
Chosen Device		TOP245	Power Out	60W
KI	0.85			
ILIMITMIN				1.38Amps
ILIMITMAX				1.68Amps
Frequency - (F)=132kHz, (H)=66kHz	f			
fS			132000.00	Hertz
fSmin			124000.00	Hertz
fSmax			140000.00	Hertz
VOR	120			Volts
VDS	10			Volts
VD	0.7			Volts
VDB	0.7			Volts
KP	0.8			
ENTER TRANSFORMER CORE/CONSTRUCTION VARIABLES				
Core Type	ef25			
Core		EF25		P/N:
Bobbin		EF25_BOBBIN		P/N:
AE			0.52	cm^2
LE			5.78	cm
AL			2000.00	nH/T^2
BW			15.60	mm
M	3			mm
L	2			
NS	2			
DC INPUT VOLTAGE PARAMETERS				
VMIN			104.94	Volts
VMAX			373.35	Volts
CURRENT WAVEFORM SHAPE PARAMETERS				
DMAX			0.56	
I AVG			0.35	Amps
IP			1.05	Amps
IR			0.84	Amps
IRMS			0.51	Amps
TRANSFORMER PRIMARY DESIGN				



PARAMETERS						
LP					504.33	uHenries
NP					60.00	
NB					8.85	
ALG					140.09	nH/T^2
BM					1710.26	Gauss
BP					2730.98	Gauss
BAC					684.10	Gauss
ur					1775.89	
LG					0.43	mm
BWE					19.20	mm
OD					0.32	mm
INS					0.05	mm
DIA					0.27	mm
AWG					30.00	AWG
CM					101.59	Cmils
CMA					200.66	Cmils/Amp
TRANSFORMER SECONDARY DESIGN PARAMETERS (SINGLE OUTPUT / SINGLE OUTPUT EQUIVALENT)						
Lumped parameters						
ISP					31.62	Amps
ISRMS					13.51	Amps
IO					8.98	Amps
IRIPPLE					10.09	Amps
CMS					2702.07	Cmils
AWGS					15.00	AWG
DIAS					1.45	mm
ODS					4.80	mm
INSS					1.67	mm
VOLTAGE STRESS PARAMETERS						
VDRAIN					645.35	Volts
PIVS					15.75	Volts
PIVB					72.07	Volts
TRANSFORMER SECONDARY DESIGN PARAMETERS (MULTIPLE OUTPUTS)						
1st output						
VO1	18.0					Volts
IO1	0.780					Amps
PO1					14.04	Watts
VD1	0.8					Volts
NS1					9.40	
ISRMS1					1.17	Amps
IRIPPLE1					0.88	Amps
PIVS1					76.49	Volts
CMS1					234.65	Cmils
AWGS1					26.00	AWG
DIAS1					0.41	mm
ODS1					1.02	mm
2nd output						



VO2	5.0					Volts
IO2	1.800					Amps
PO2					9.00	Watts
VD2	0.7					Volts
NS2					2.85	
ISRMS2					2.71	Amps
IRIPPLE2					2.02	Amps
PIVS2					22.73	Volts
CMS2					541.51	Cmils
AWGS2					22.00	AWG
DIAS2					0.65	mm
ODS2					3.37	mm
3rd output						
VO3	3.3					Volts
IO3	2.000					Amps
PO3					6.60	Watts
VD3	0.7					Volts
NS3					2.00	
ISRMS3					3.01	Amps
IRIPPLE3					2.25	Amps
PIVS3					15.75	Volts
CMS3					601.68	Cmils
AWGS3					22.00	AWG
DIAS3					0.65	mm
ODS3					4.80	mm
Total power					29.64	Watts



9 Performance Data

All measurements performed at room temperature, 50 Hz input frequency.

9.1 Efficiency

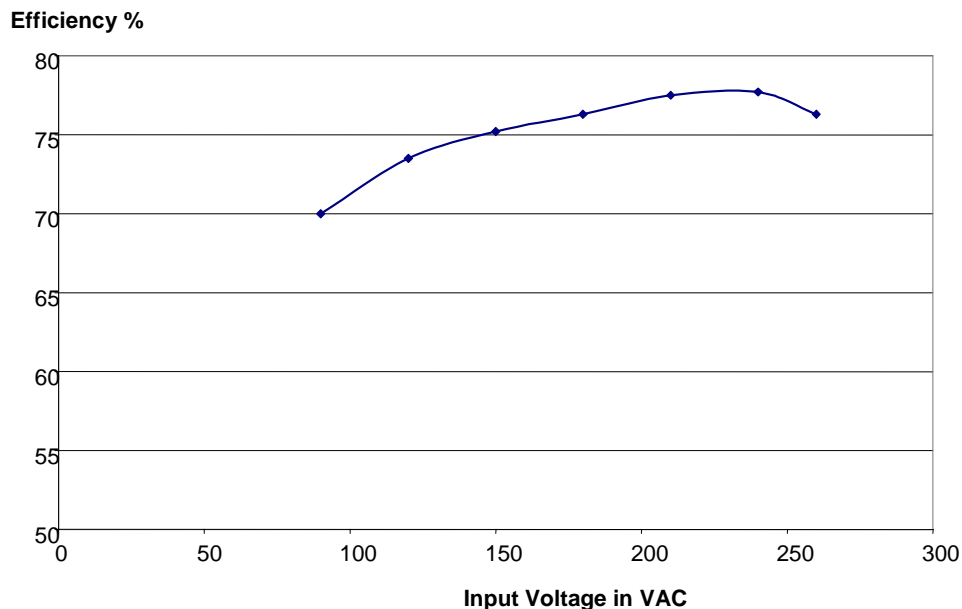

Figure 6- Efficiency vs. Input Voltage, Room Temperature, 50 Hz.

9.2 No-load Input Power

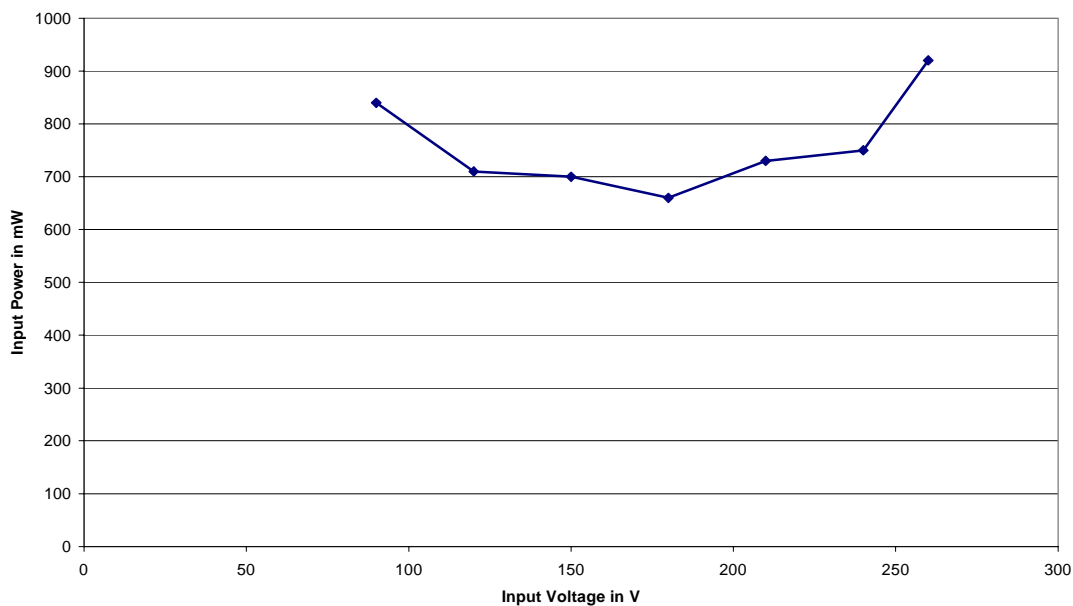

Figure 7- Zero Load Input Power vs. Input Line Voltage, Room Temperature, 50 Hz.



9.3 Regulation

9.3.1 Line Regulation (Transformer Outputs only)

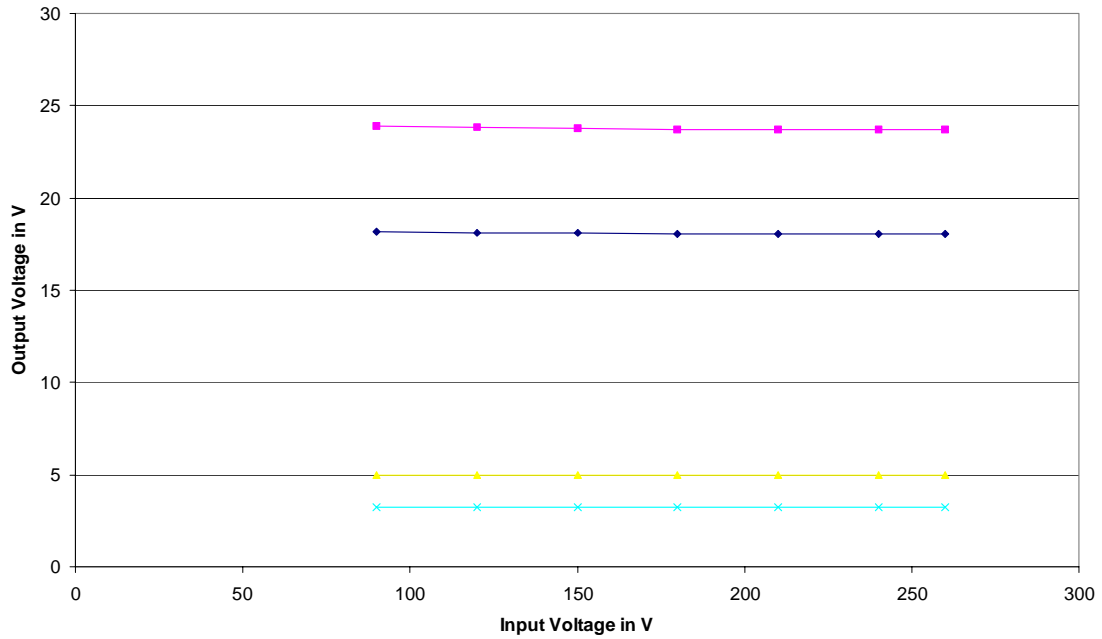

Figure 8 – Line Regulation, Room Temperature, Full Load.



9.3.2 Cross Regulation (18V Output)

	23V Rail (A)	5V Rail (A)	3V3 Rail (A)
Min Load (X)	0.2	0.55	0.23
Max Load (M)	0.6	1.8	1.3
Load Combinations	Voltage (V)	Voltage (V)	Voltage (V)
23V - 5V - 3V3			
XXX	23.24	5.01	3.26
XXM	24.3	5.2	3.2
XXM	24.01	4.84	3.32
MXX	22.73	4.98	3.25
XMM	24.88	5.01	3.23
MMX	23.16	4.86	3.29
MMM	23.76	4.99	3.22
Min (V)	22.73	4.84	3.2
Max (V)	24.88	5.2	3.32
% Below	-1.17	-3.20	-3.03
% Above	8.17	4.00	0.61

9.3.3 Cross Regulation (23V Output)

	18V Rail (A)	5V Rail (A)	3V3 Rail (A)
Min Load (X)	0.2	0.55	0.23
Max Load (M)	0.6	1.8	1.3
Load Combinations	Voltage (V)	Voltage (V)	Voltage (V)
18V - 5V - 3V3			
XXX	18.08	4.98	3.22
XXM	18.76	5.22	3.19
XXM	18.49	4.8	3.34
MXX	17.18	4.95	3.25
XMM	19.34	5	3.23
MMX	17.58	4.86	3.3
MMM	18.05	4.98	3.23
Min (V)	17.18	4.8	3.19
Max (V)	19.34	5.22	3.34
% Below	-4.56	-4.00	-3.33
% Above	7.44	4.40	1.21



Thermal Performance

Temperature		
Item	90 VAC	260 VAC
Ambient	25°C	25°C
Common Mode Choke (L5)	43.5°C	26°C
Bridge (D4, D5, D9, D10)	42.5°C	37°C
Transformer (T1)	56°C	53.5°C
Clamp Resistor (R5)	46°C	31°C
<i>TOPSwitch</i> (U1)	69.5°C	62°C
Rectifier D2	48.5°C	41°C
Rectifier D3	39.5°C	37°C
Rectifier D6	41.5°C	39°C
Rectifier D8	41°C	39.5°C
Resistor R21	56.5°C	56°C



10 Waveforms

10.1 Drain Voltage and Current, Normal Operation

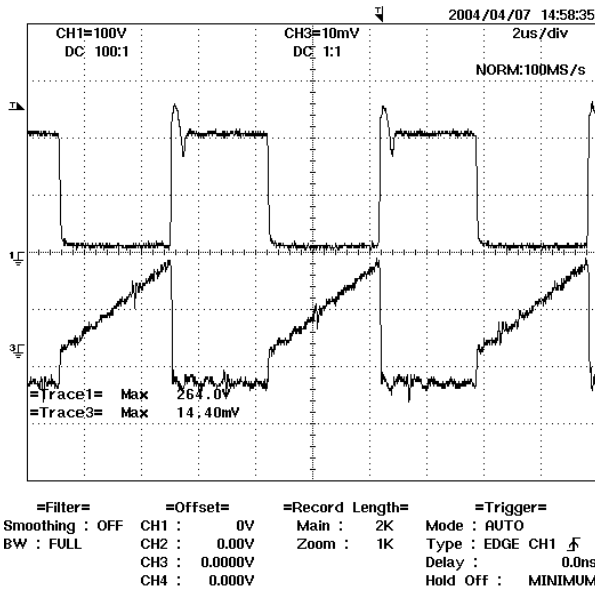

Figure 9 - 90 VAC, Full Load.
Upper: I_{DRAIN} , 0.5 A / div
Lower: V_{DRAIN} , 100 V, 2 μ s / div

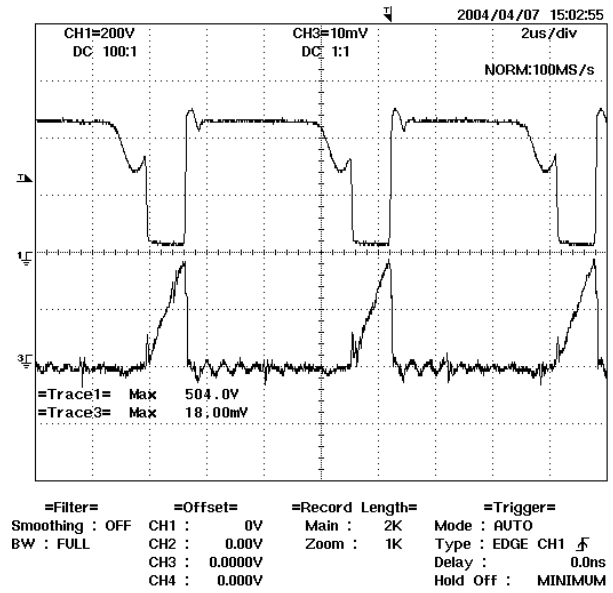

Figure 10 - 265 VAC, Full Load
Upper: I_{DRAIN} , 0.5 A / div
Lower: V_{DRAIN} , 200 V / div

10.2 Output Voltage Start-up Profile (from Transformer Outputs only)

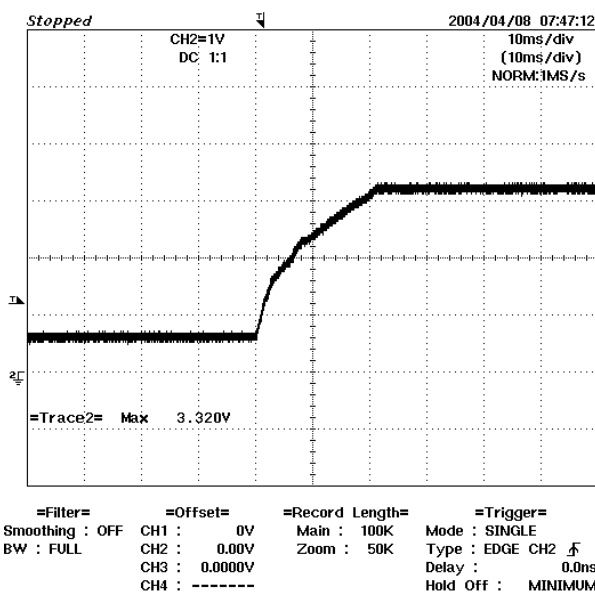

Figure 11 - 3V3 Start-up Profile, 90VAC
1 V, 10 ms / div.

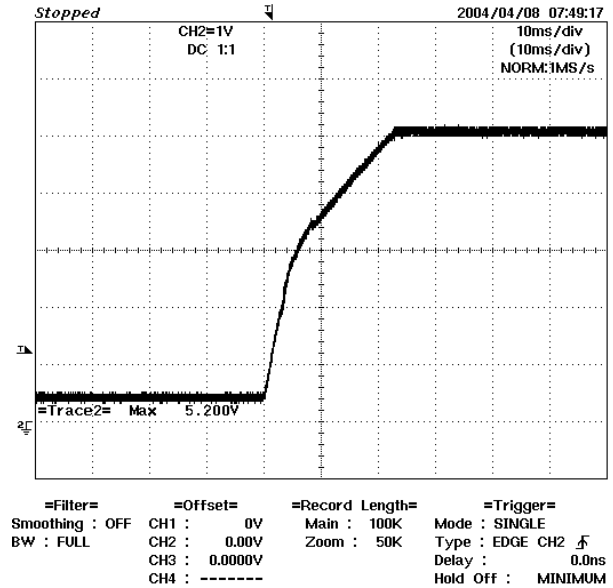

Figure 12 - 5V Start-up Profile, 90 VAC
1 V, 10 ms / div.



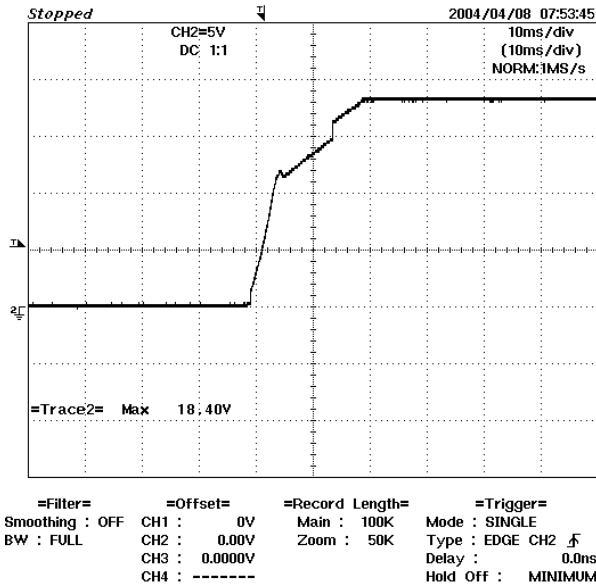

Figure 13 – 18V Start-up Profile, 90VAC
5 V, 10 ms / div.

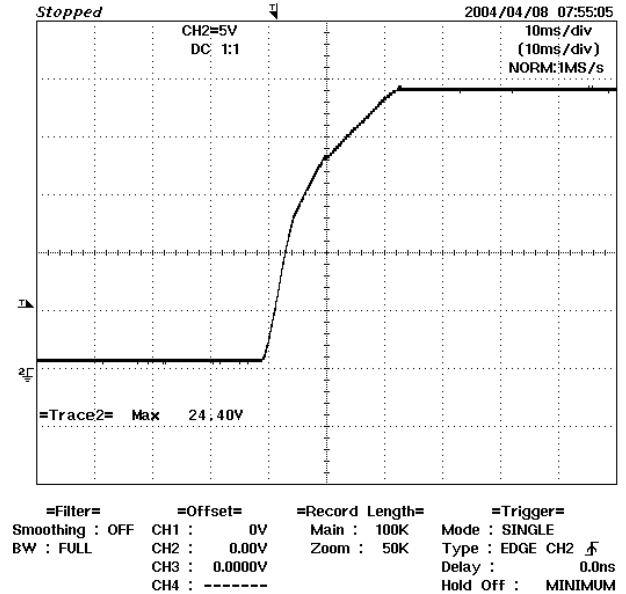

Figure 14 – 23V Start-up Profile, 90 VAC
5 V, 10 ms / div.

10.3 Drain Voltage and Current Start-up Profile

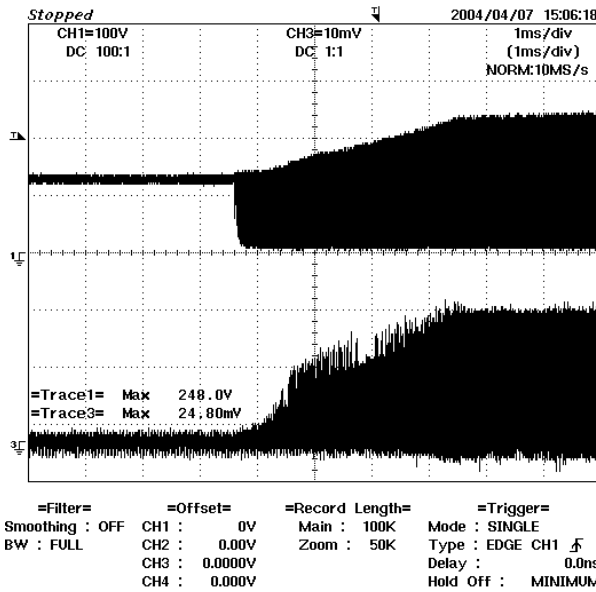

Figure 15 - 90 VAC Input and Maximum Load.
Upper: I_{DRAIN} , 0.5 A / div.
Lower: V_{DRAIN} , 100 V & 1 ms / div.

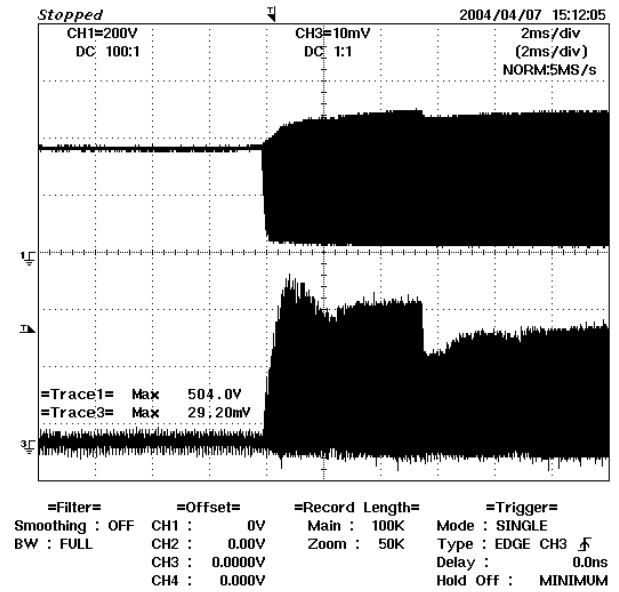

Figure 16 - 265 VAC Input and Maximum Load.
Upper: I_{DRAIN} , 0.5 A / div.
Lower: V_{DRAIN} , 200 V & 1 ms / div.

10.4 Load Transient Response

In the figures shown below, signal averaging was used to better enable viewing the load transient response. The oscilloscope was triggered using the load current step as a trigger source. Since the output switching and line frequency occur essentially at random



with respect to the load transient, contributions to the output ripple from these sources will average out, leaving the contribution only from the load step response.

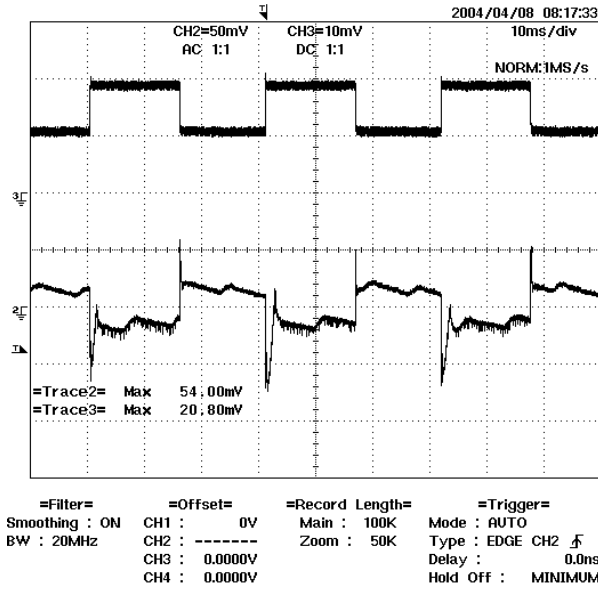

Figure 17 – Transient Response, 90 VAC, 60-100-60% Load Step.
Top: Load Current, 1 A/div.
Bottom: 3V3 Output Voltage
10 mV, 10 ms / div.

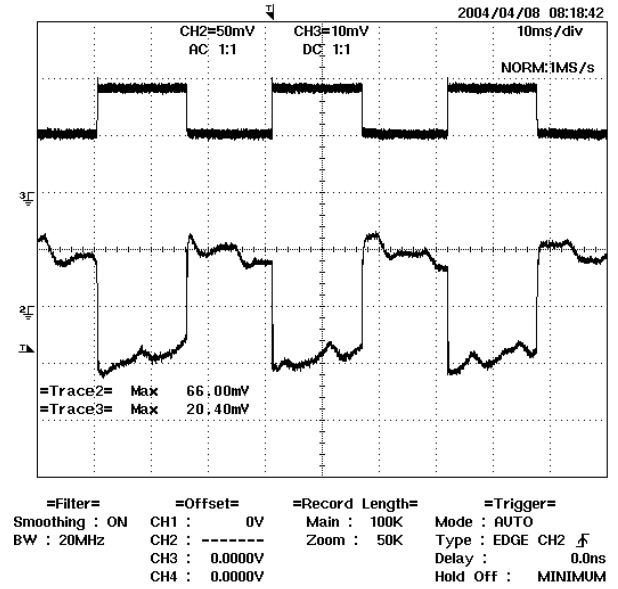

Figure 18 – Transient Response, 90 VAC, 60-100-60% Load Step
Upper: Load Current, 1 A/ div.
Bottom: 5V Output Voltage
10 mV, 10 ms / div.

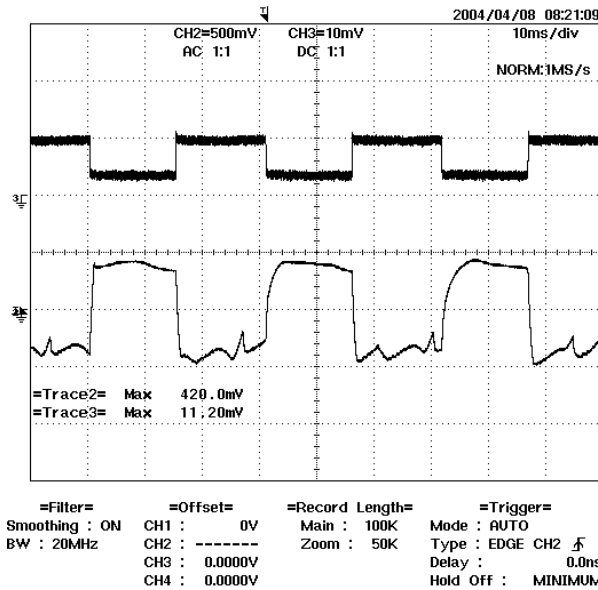

Figure 19 – Transient Response, 90 VAC, 50-100-50% Load Step.
Top: Load Current, 0.5 A/div.
Bottom: 18V Output Voltage
10 mV, 10 ms / div.

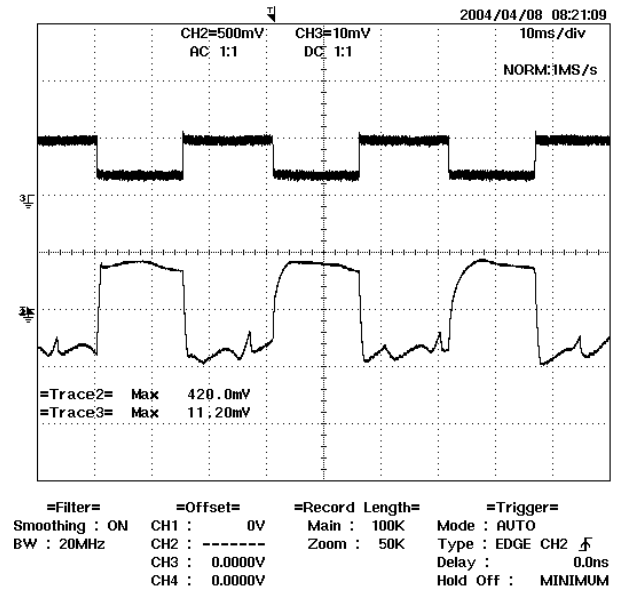

Figure 20 – Transient Response, 90 VAC, 50-100-50% Load Step
Upper: Load Current, 0.5 A/ div.
Bottom: 23V Output Voltage
10 mV, 10 ms / div.

Output Ripple Measurements

10.4.1 Ripple Measurement Technique

For DC output ripple measurements, a modified oscilloscope test probe must be utilized in order to reduce spurious signals due to pickup. Details of the probe modification are provided in Figure 21 and Figure 22.

The 5125BA probe adapter is affixed with two capacitors tied in parallel across the probe tip. The capacitors include one (1) 0.1 $\mu\text{F}/50\text{ V}$ ceramic type and one (1) 1.0 $\mu\text{F}/50\text{ V}$ aluminum electrolytic. **The aluminum electrolytic type capacitor is polarized, so proper polarity across DC outputs must be maintained (see below).**

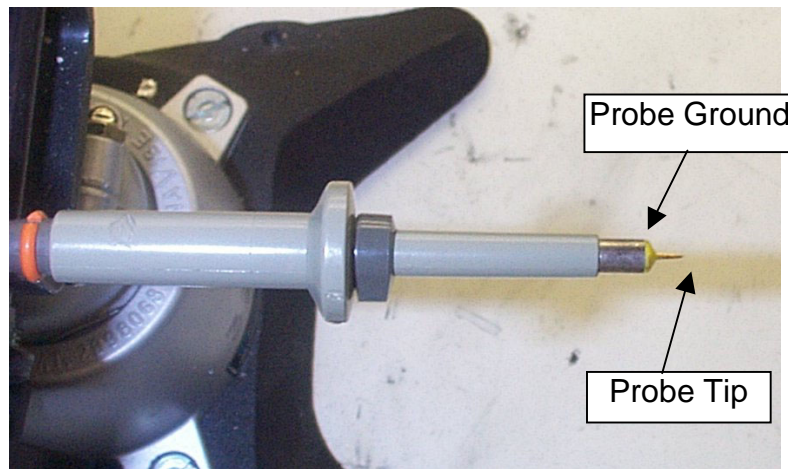

Figure 21 - Oscilloscope Probe Prepared for Ripple Measurement. (End Cap and Ground Lead Removed)

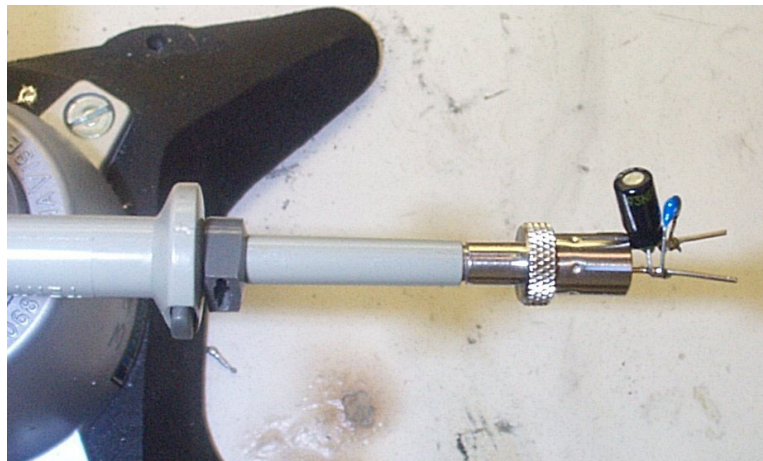

Figure 22 - Oscilloscope Probe with Probe Master 5125BA BNC Adapter. (Modified with wires for probe ground for ripple measurement, and two parallel decoupling capacitors added)

10.4.2 Measurement Results (Transformer Outputs only)

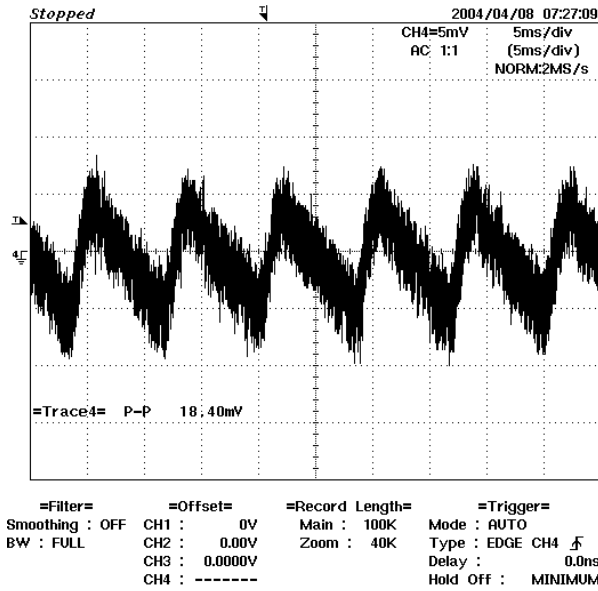

Figure 23 – 3V3Ripple, 90 VAC, Full Load.
5 ms, 5 mV / div

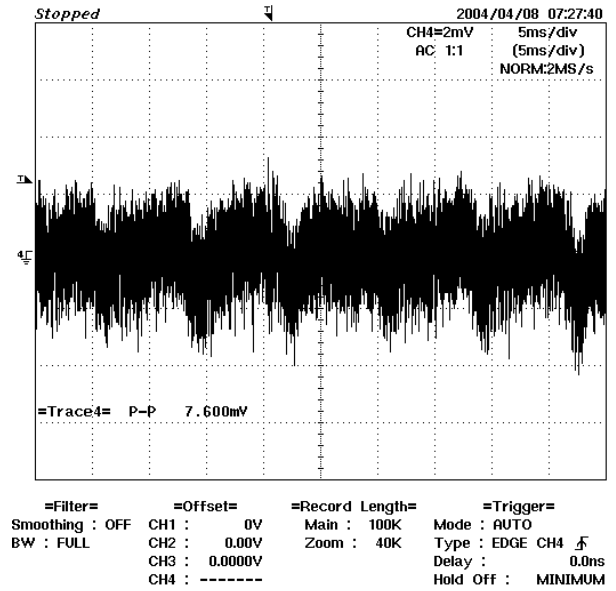

Figure 24 – 3V3 Ripple, 265 VAC, Full Load.
5 ms, 5 mV / div

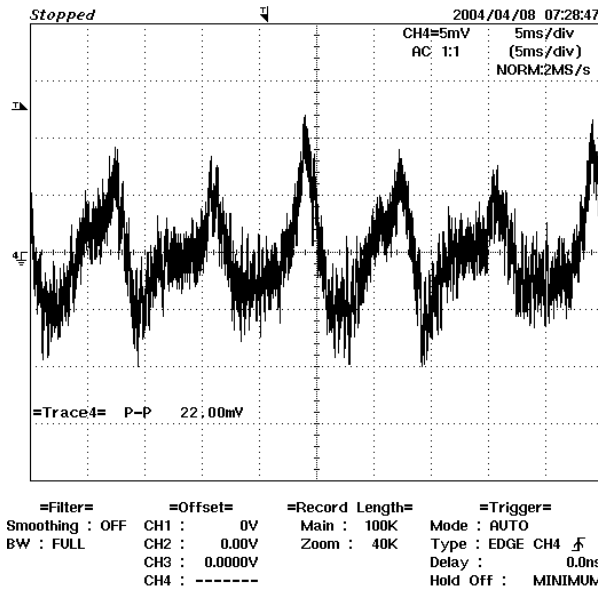

Figure 25 – 5V Ripple, 90 VAC, Full Load.
2 ms, 5 mV / div

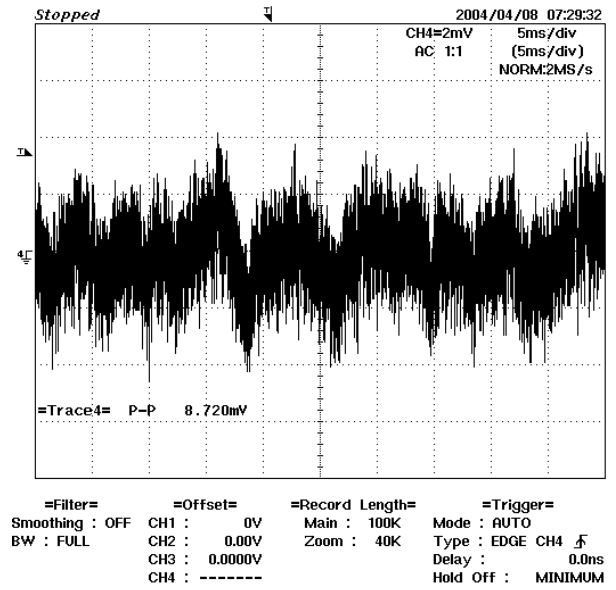

Figure 26 - 5 V Ripple, 265 VAC, Full Load.
2 ms, 2 mV / div

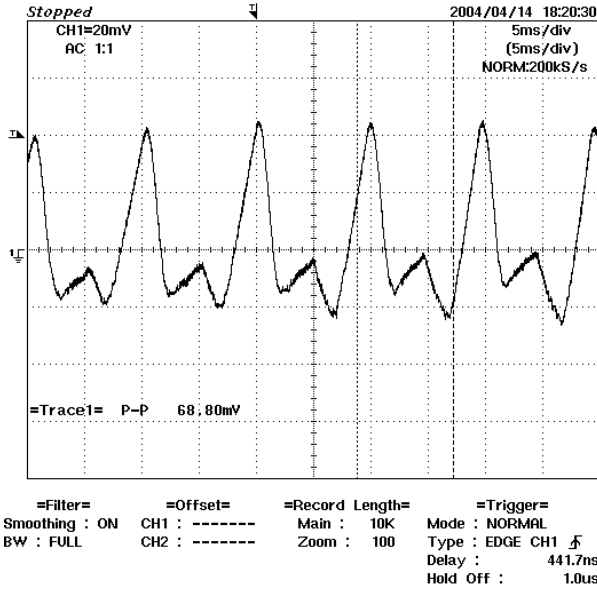

Figure 27 – 18V Ripple, 90 VAC, Full Load.
 5 ms, 20 mV / div

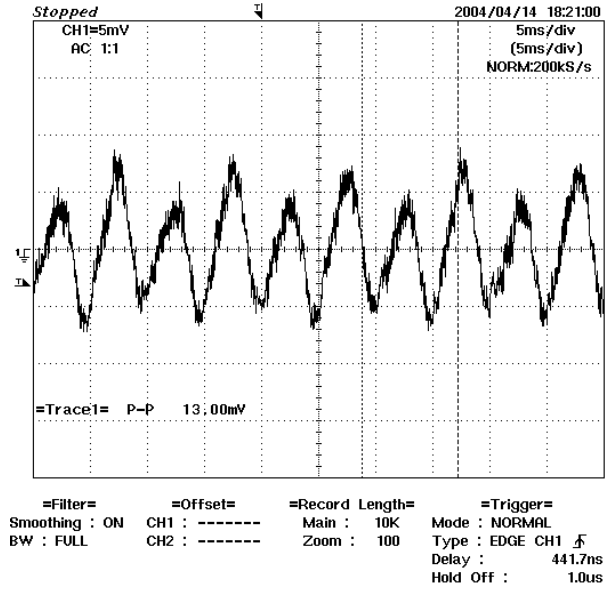

Figure 28 - 18V Ripple, 265 VAC, Full Load.
 5 ms, 20 mV / div

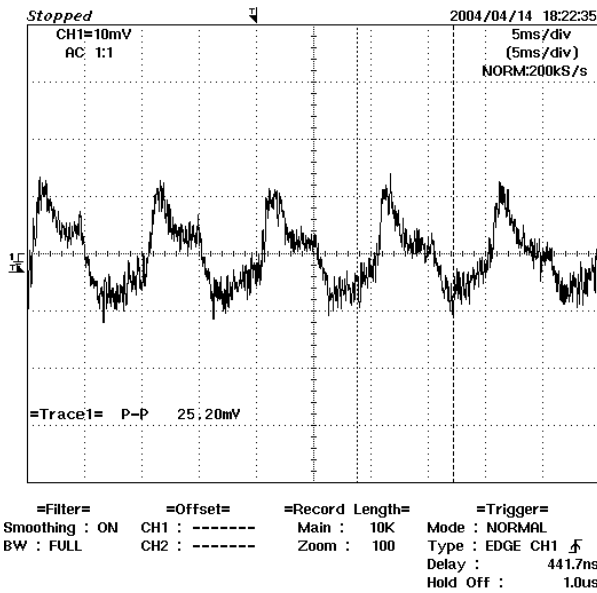

Figure 29 – 23V Ripple, 90 VAC, Full Load.
 2 ms, 50 mV / div

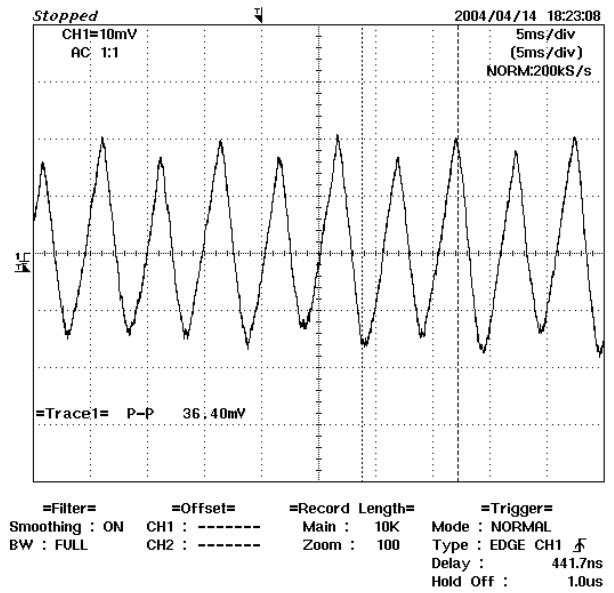

Figure 30 – 23V Ripple, 265 VAC, Full Load.
 5 ms, 20 mV / div



11 Conducted EMI

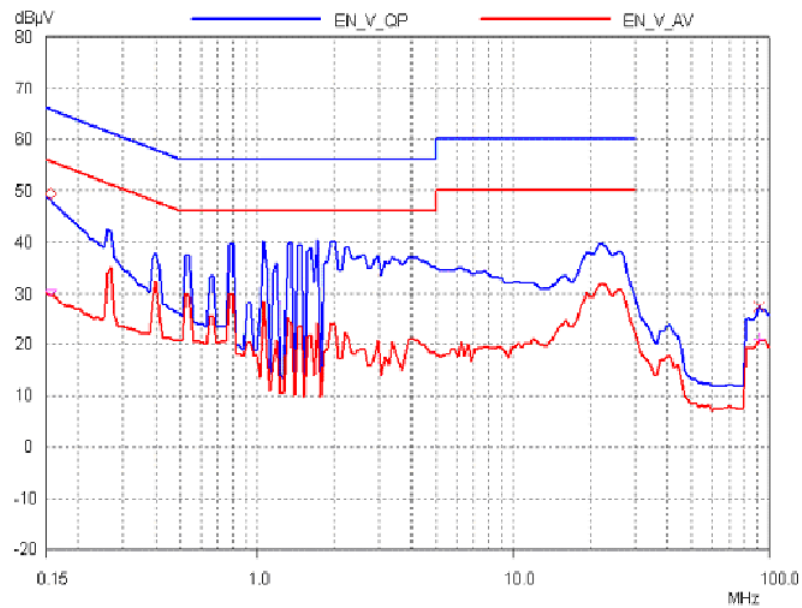

Figure 32 - Conducted EMI, Maximum Steady State Load, 115 VAC, 50 Hz, and EN55022 B Limits, Artificial Hand not connected

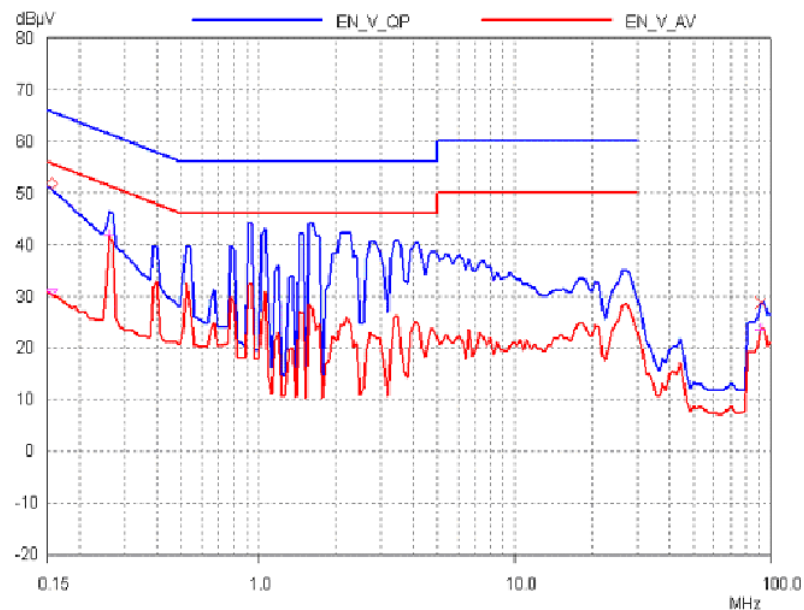

Figure 33 - Conducted EMI, Maximum Steady State Load, 230 VAC, 50 Hz, and EN55022 B Limits. Artificial Hand connected



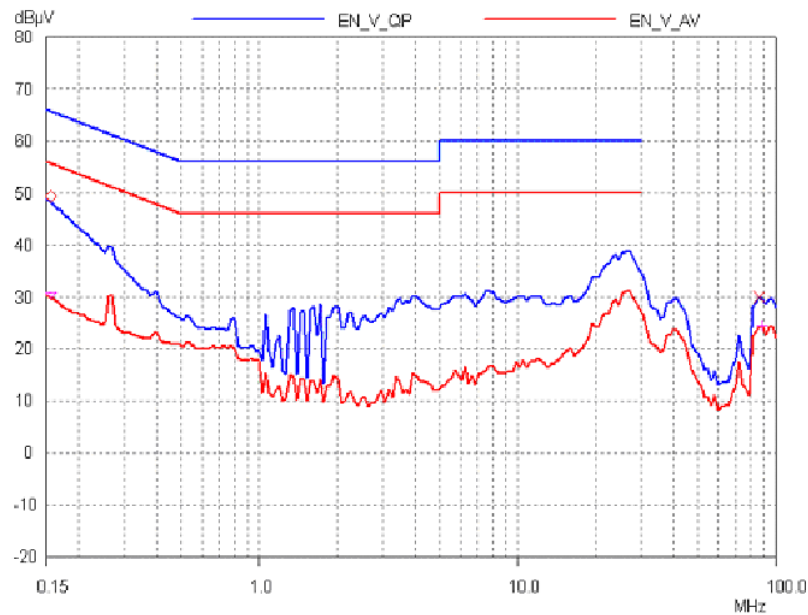

Figure 34 - Conducted EMI, Maximum Steady State Load, 115 VAC, 50 Hz, and EN55022 B Limits, Artificial Hand connected to secondary ground

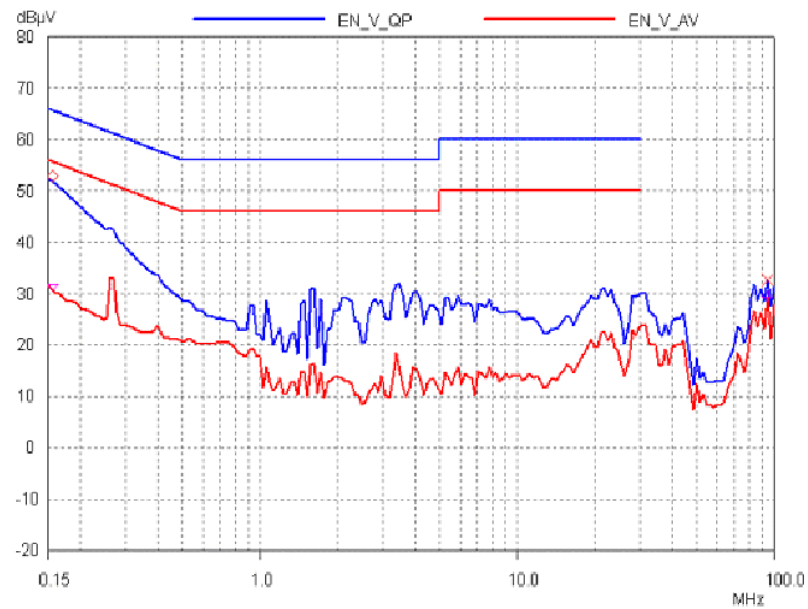

Figure 35 - Conducted EMI, Maximum Steady State Load, 230 VAC, 50 Hz, and EN55022 B Limits. Artificial Hand connected to secondary ground



12 Revision History

Date	Author	Revision	Description & changes	Reviewed
April 20, 2005	HM	1.0	Initial Release	VC / AM



For the latest updates, visit our Web site: www.powerint.com

Power Integrations may make changes to its products at any time. Power Integrations has no liability arising from your use of any information, device or circuit described herein nor does it convey any license under its patent rights or the rights of others. POWER INTEGRATIONS MAKES NO WARRANTIES HEREIN AND SPECIFICALLY DISCLAIMS ALL WARRANTIES INCLUDING, WITHOUT LIMITATION, THE IMPLIED WARRANTIES OF MERCHANTABILITY, FITNESS FOR A PARTICULAR PURPOSE, AND NON-INFRINGEMENT OF THIRD PARTY RIGHTS.

PATENT INFORMATION

The products and applications illustrated herein (including circuits external to the products and transformer construction) may be covered by one or more U.S. and foreign patents or potentially by pending U.S. and foreign patent applications assigned to Power Integrations. A complete list of Power Integrations' patents may be found at www.powerint.com.

The PI Logo, **TOPSwitch**, **TinySwitch**, **LinkSwitch**, and **EcoSmart** are registered trademarks of Power Integrations. **PI Expert** and **DPA-Switch** are trademarks of Power Integrations.
© Copyright 2004, Power Integrations.

WORLD HEADQUARTERS

Power Integrations
5245 Hellyer Avenue,
San Jose, CA 95138, USA
Main: +1-408-414-9200
Customer Service:
Phone: +1-408-414-9665
Fax: +1-408-414-9765
e-mail:
usasales@powerint.com

AMERICAS

Power Integrations, Inc.
4335 South Lee Street,
Suite G,
Buford, GA 30518, USA
Phone: +1-678-714-6033
Fax: +1-678-714-6012
e-mail:
usasales@powerint.com

CHINA (SHANGHAI)

Power Integrations
International Holdings, Inc.
Rm 807, Pacheer,
Commercial Centre,
555 Nanjing West Road,
Shanghai, 200041, China
Phone: +86-21-6215-5548
Fax: +86-21-6215-2468
e-mail:
chinasales@powerint.com

APPLICATIONS HOTLINE

World Wide +1-408-414-9660

CHINA (SHENZHEN)

Power Integrations
International Holdings, Inc.
Rm# 1705, Bao Hua Bldg.
1016 Hua Qiang Bei Lu,
Shenzhen, Guangdong,
518031, China
Phone: +86-755-8367-5143
Fax: +86-755-8377-9610
e-mail: chinasales@powerint.com

GERMANY

Power Integrations, GmbH
Rueckertstrasse 3,
D-80336, Munich, Germany
Phone: +49-895-527-3910
Fax: +49-895-527-3920
e-mail: eurosales@powerint.com

INDIA (TECHNICAL SUPPORT)

Innovatech
261/A, Ground Floor
7th Main, 17th Cross,
Sadashivanagar
Bangalore, India, 560080
Phone: +91-80-5113-8020
Fax: +91-80-5113-8023
e-mail: indiasales@powerint.com

APPLICATIONS FAX

World Wide +1-408-414-9760

ITALY

Power Integrations s.r.l.
Via Vittorio Veneto 12,
Bresso, Milano,
20091, Italy
Phone: +39-028-928-6001
Fax: +39-028-928-6009
e-mail:
eurosales@powerint.com

JAPAN

Power Integrations, K.K.
Keihin-Tatemono 1st Bldg.
12-20 Shin-Yokohama,
2-Chome,
Kohoku-ku, Yokohama-shi,
Kanagawa 222-0033, Japan
Phone: +81-45-471-1021
Fax: +81-45-471-3717
e-mail:
japansales@powerint.com

KOREA

Power Integrations
International Holdings, Inc.
8th Floor, DongSung Bldg.
17-8 Yoido-dong,
Youngdeungpo-gu,
Seoul, 150-874, Korea
Phone: +82-2-782-2840
Fax: +82-2-782-4427
e-mail:
koreasales@powerint.com

SINGAPORE (ASIA PACIFIC HEADQUARTERS)

Power Integrations, Singapore
51 Newton Road,
#15-08/10 Goldhill Plaza,
Singapore, 308900
Phone: +65-6358-2160
Fax: +65-6358-2015
e-mail:
singaporesales@powerint.com

TAIWAN

Power Integrations
International Holdings, Inc.
17F-3, No. 510,
Chung Hsiao E. Rd., Sec. 5,
Taipei, Taiwan 110, R.O.C.
Phone: +886-2-2727-1221
Fax: +886-2-2727-1223
e-mail:
taiwansales@powerint.com

UK (EUROPE & AFRICA HEADQUARTERS)

1st Floor, St. James's House
East Street
Farnham, Surrey GU9 7TJ
United Kingdom
Phone: +44-1252-730-140
Fax: +44-1252-727-689
e-mail: eurosales@powerint.com

