

DIP to SOIC Adapter Modules

DIP to SOIC ADAPTER MODULES ELIMINATE THE NEED TO REDESIGN MOTHERBOARDS OR MAY BE USED FOR BREADBOARD PROTOTYPING

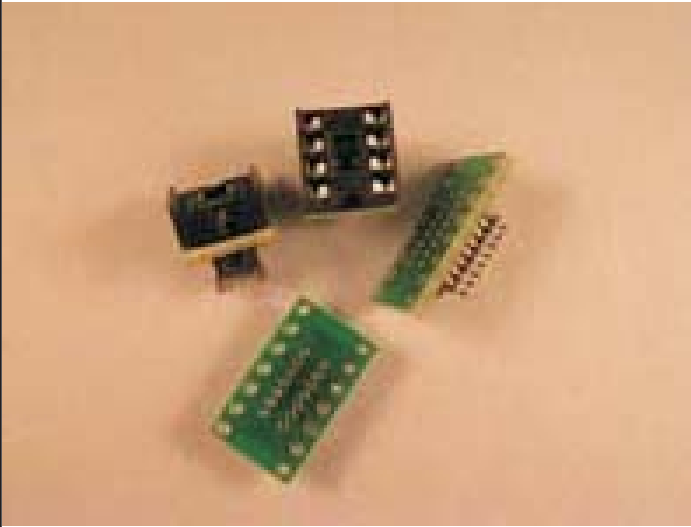

DESCRIPTION

The Accutek SOIC family of Adapter Modules permit the connection of older Dual-Inline-Packages onto circuit board sites which are designed for standard pitch SOIC devices.

Accutek SOIC's provide a one-to-one footprint with standard SOIC's for adapting DIP packages onto printed circuit boards. These adapter modules save costly motherboard redesigns.

Accutek SOIC's are offered with standard 8, 14, 16 and 20 pin counts to accommodate components with 0.050" (0.65mm) lead spacing and 0.250" (5.0mm) body width.

Accutek DIP to SOIC Adapter Modules are available with 0.032" pin holes ready to solder a DIP IC into, or they are available with a socket installed ready for the DIP IC to be inserted.

All modules are designed in-house using PCB CAD workstations. Final assembly and 100% testing are also performed in-house.

FEATURES

- Saves costly redesign of current motherboards
- Fully tested with lifetime limited warranty
- IC assembly and testing available
- EPROM and Flash programming available
- Custom configurations available

ORDERING OPTIONS

- Adapter only
- Customer supplies chips - Accutek assembles on Accutek adapters, tests and delivers finished product in antistatic tubes.
- Complete turnkey - Accutek purchases IC's and passives. Then assembles, tests and delivers finished product in antistatic tubes.

AK08SOIC-D300
8 PIN 0.300" DIP TO SOIC

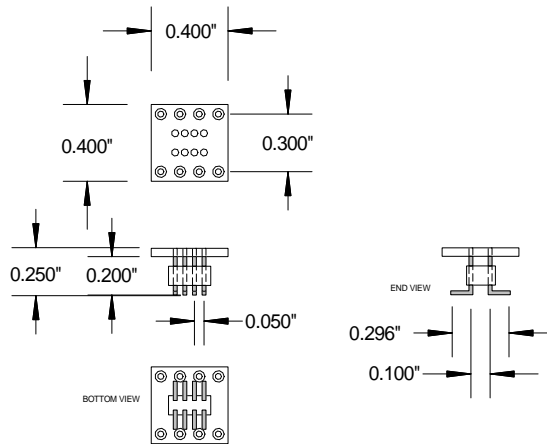

AK08SOIC-D300S
8 PIN 0.300" DIP SOCKET TO SOIC

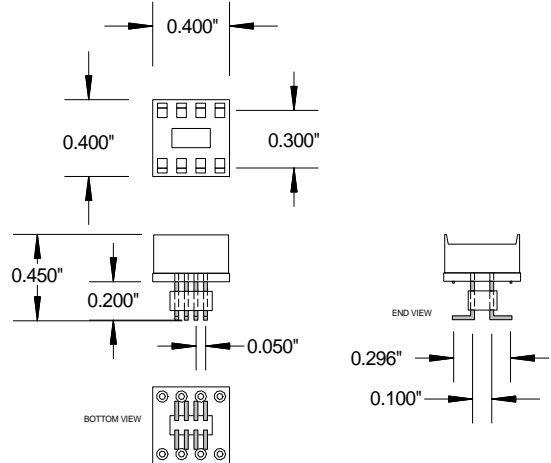

AK14SOIC-D300
14 PIN 0.300" DIP TO SOIC

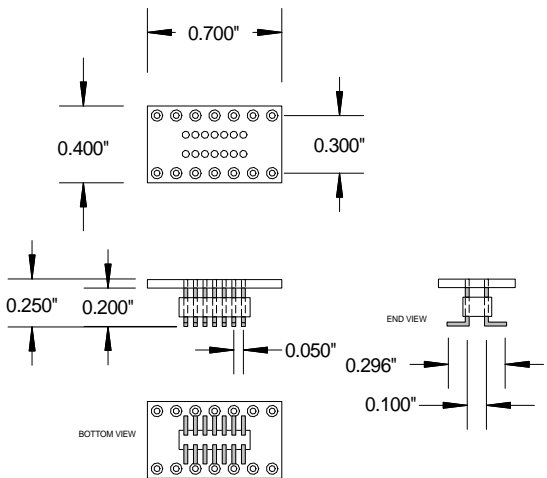

AK14SOIC-D300S
14 PIN 0.300" DIP SOCKET TO SOIC

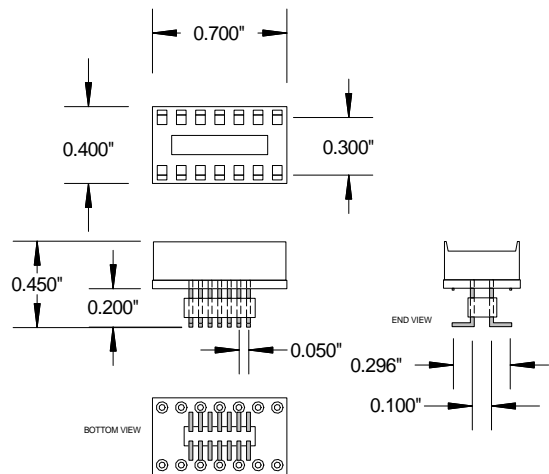

AK16SOIC-D300
16 PIN 0.300" DIP TO SOIC

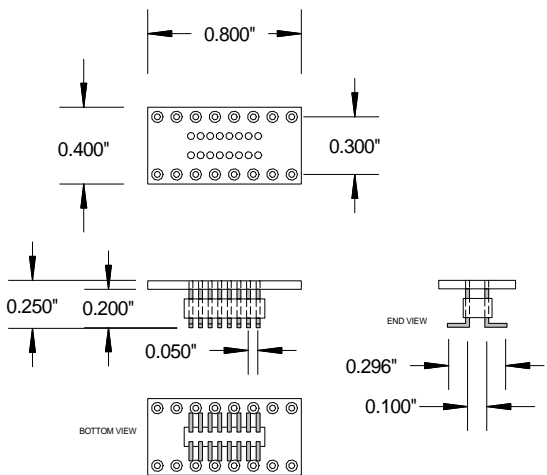

AK16SOIC-D300S
16 PIN 0.300" DIP SOCKET TO SOIC

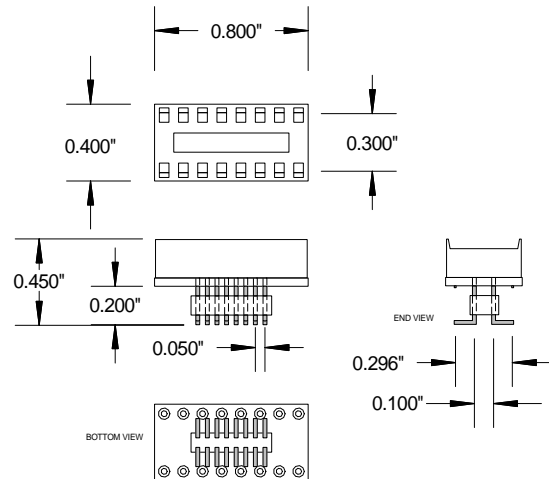

AK18SOIC-D300
18 PIN 0.300" DIP TO SOIC

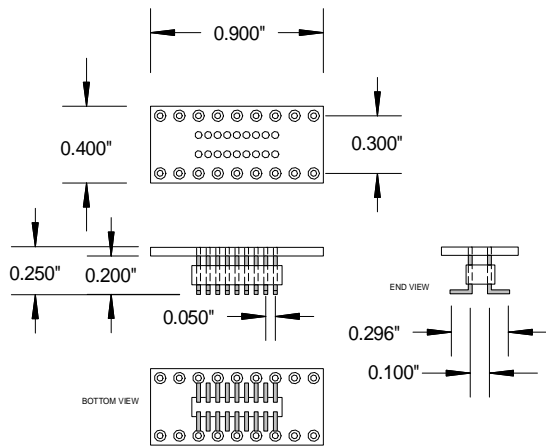

AK18SOIC-D300S
18 PIN 0.300" DIP SOCKET TO SOIC

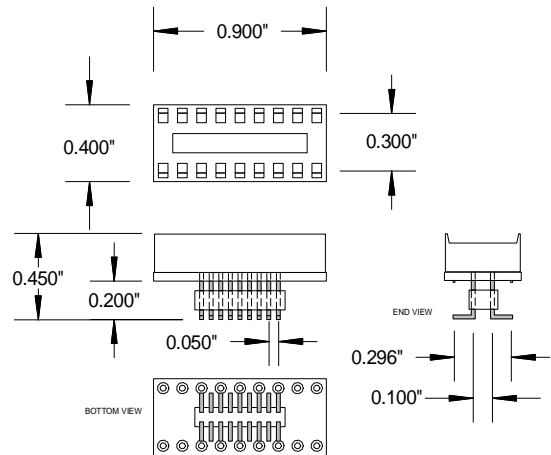

AK20SOIC-D300
20 PIN 0.300" DIP TO SOIC

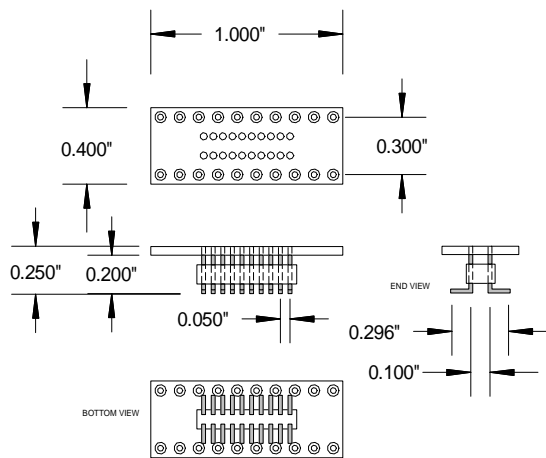

AK20SOIC-D300S
20 PIN 0.300" DIP SOCKET TO SOIC

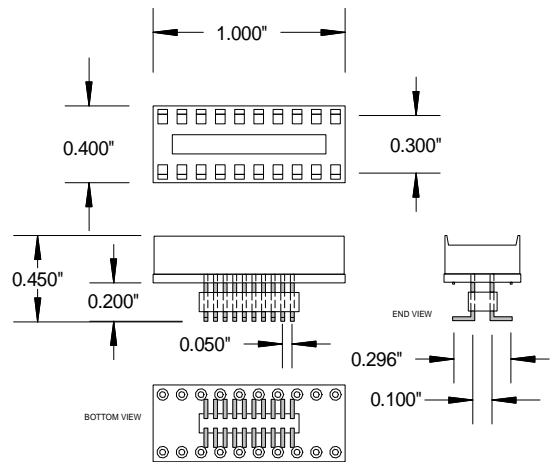

AK20WSOIC-D300
20 PIN 0.300" DIP TO SOIC

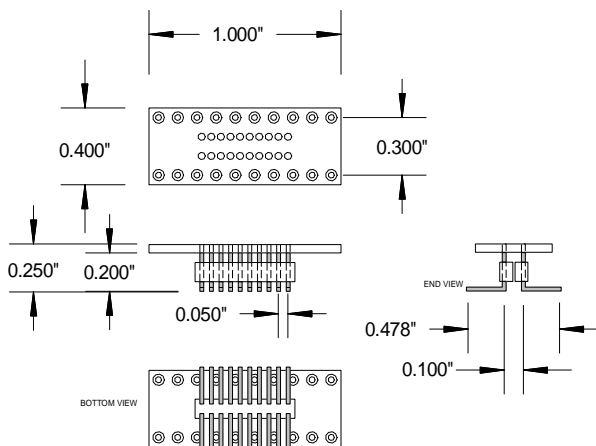

AK20WSOIC-D300S
20 PIN 0.300" DIP SOCKET TO SOIC

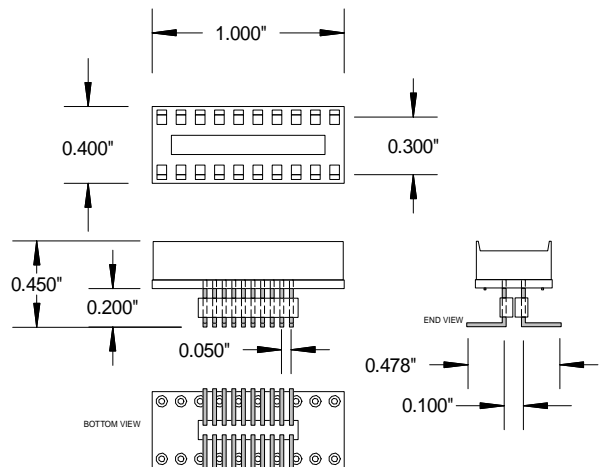

AK22SOIC-D300
22 PIN 0.300" DIP TO SOIC

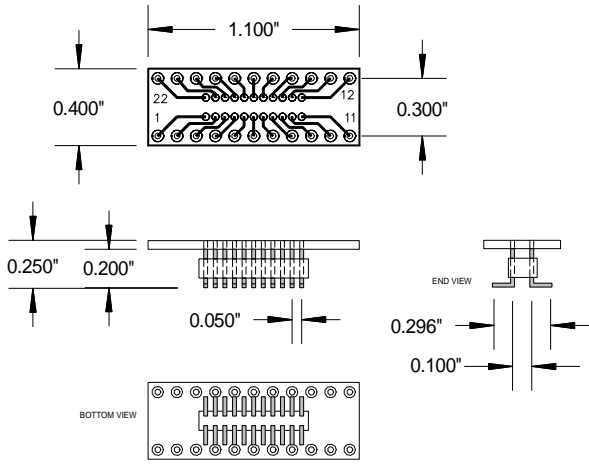

AK22SOIC-D300

AK22SOIC-D300S
22 PIN 0.300" DIP SOCKET TO SOIC

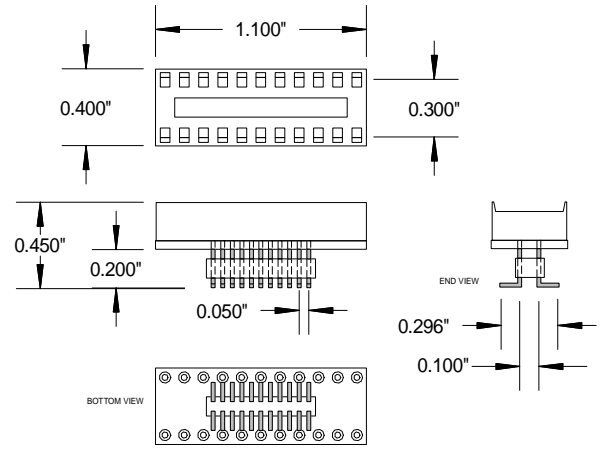

AK22WSOIC-D300
22 PIN 0.300" DIP TO WIDE SOIC

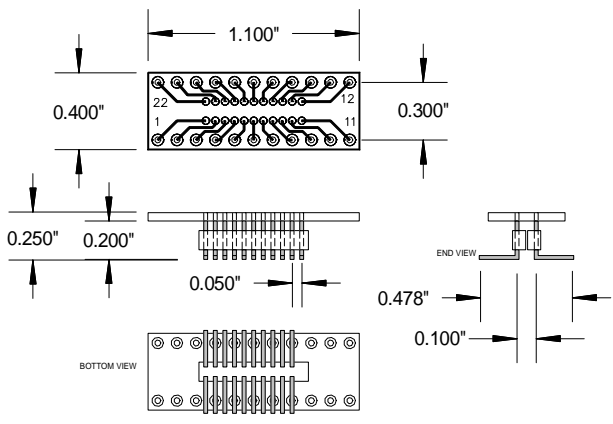

AK22WSOIC-D300S
22 PIN 0.300" DIP SOCKET TO WIDE SOIC

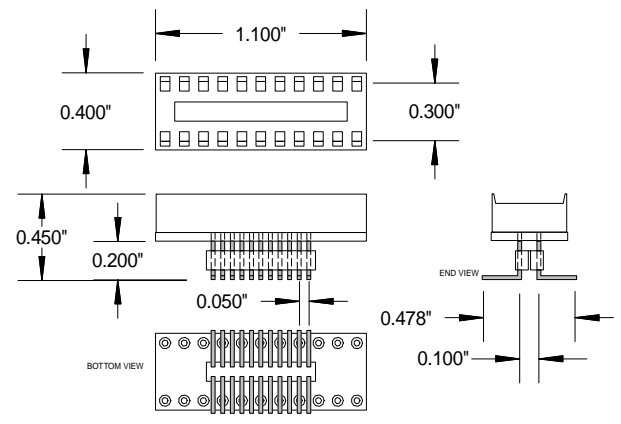

AK24SOIC-D300
24 PIN 0.300" DIP TO SOIC

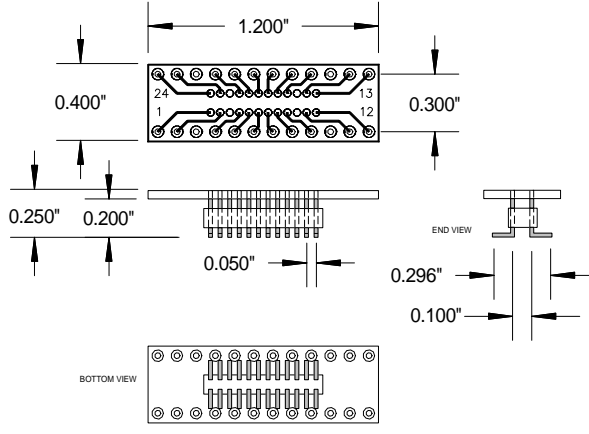

AK24SOIC-D300S
24 PIN 0.300" DIP SOCKET TO SOIC

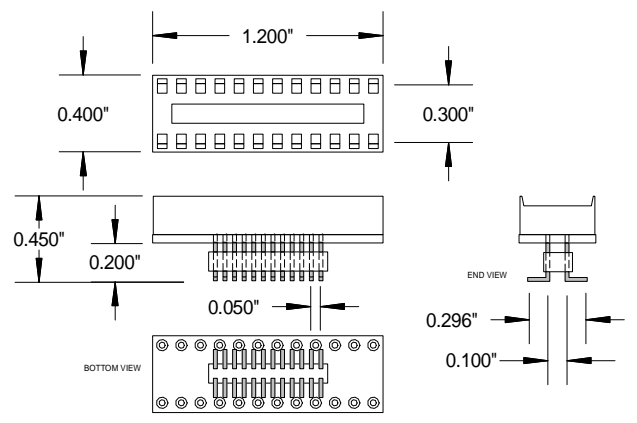

AK24WSOIC-D300
24 PIN .300" DIP TO WIDE SOIC

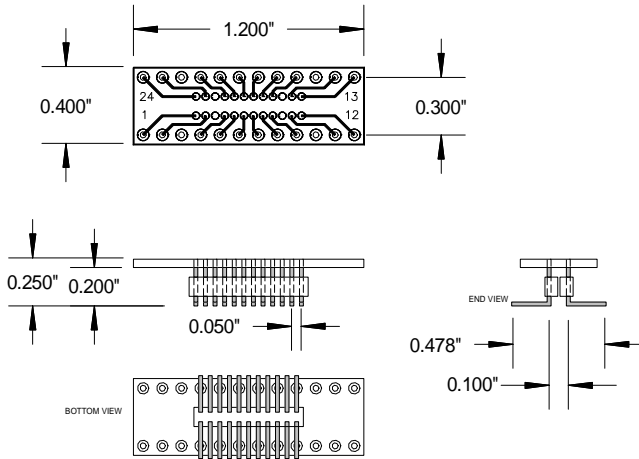

AK24WSOIC-D300S
24 PIN .300" DIP SOCKET TO WIDE SOIC

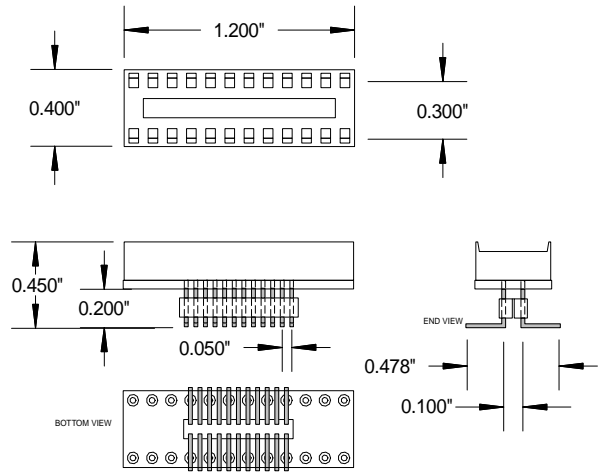

AK24SOIC-D600
24 PIN .600" DIP TO SOIC

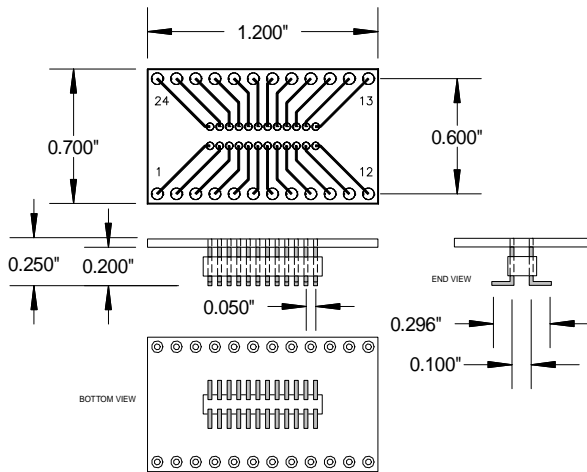

AK24SOIC-D600S
24 PIN .600" DIP SOCKET TO SOIC

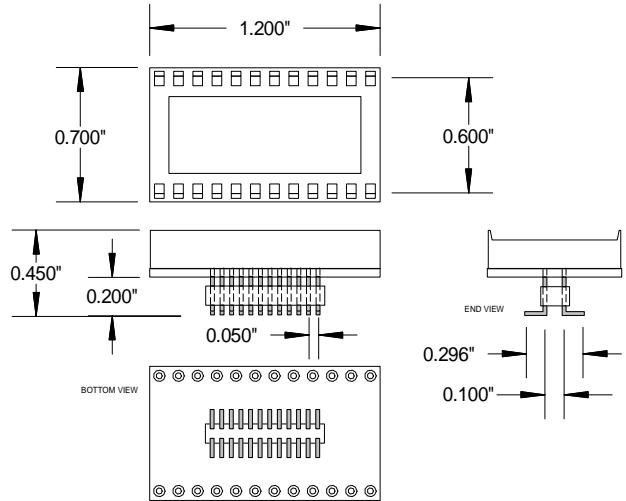

AK24WSOIC-D600
24 PIN .600" DIP TO SOIC

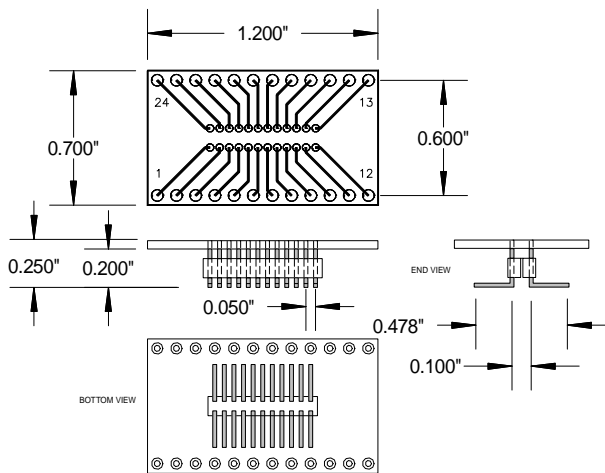

AK24WSOIC-D600S
24 PIN .600" DIP SOCKET TO SOIC

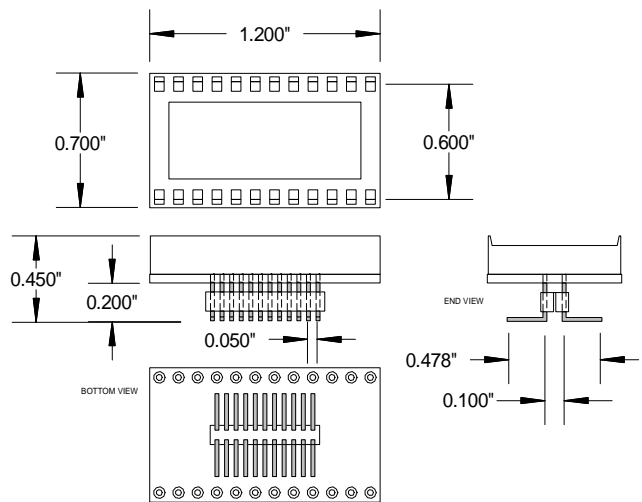

AK28SOIC-D300
28 PIN 0.300" DIP TO NARROW SOIC

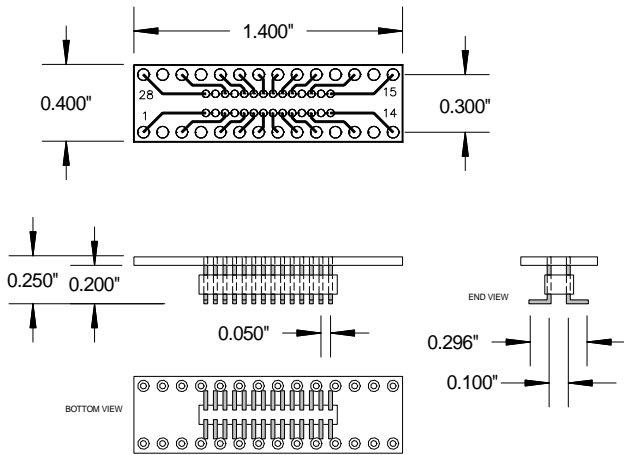

AK28SOIC-D300S
28 PIN 0.300" DIP SOCKET TO NARROW SOIC

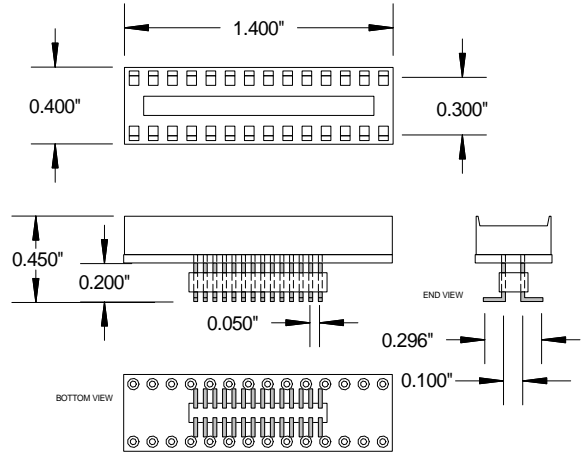

AK28WSOIC-D300
28 PIN 0.300" DIP TO WIDE SOIC

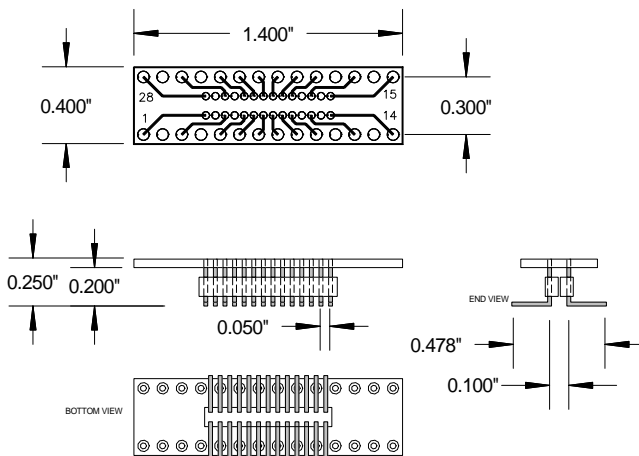

AK28WSOIC-D300S
28 PIN 0.300" DIP SOCKET TO WIDE SOIC

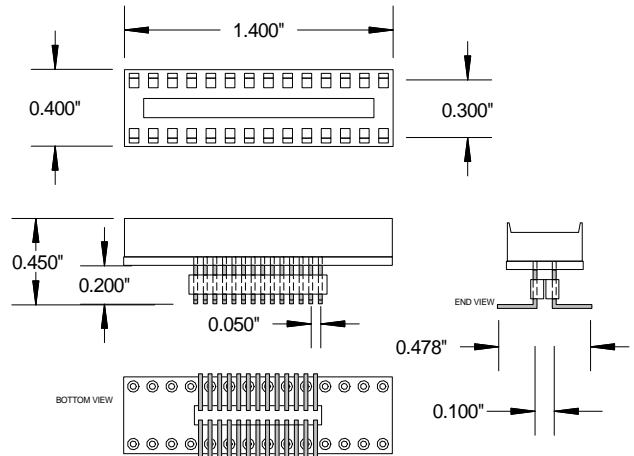

AK28SOIC-D600
28 PIN .600" DIP TO SOIC

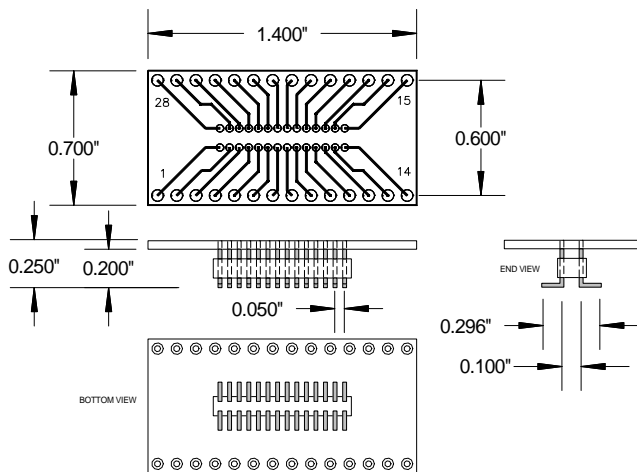

AK28SOIC-D600S
28 PIN .600" DIP SOCKET TO SOIC

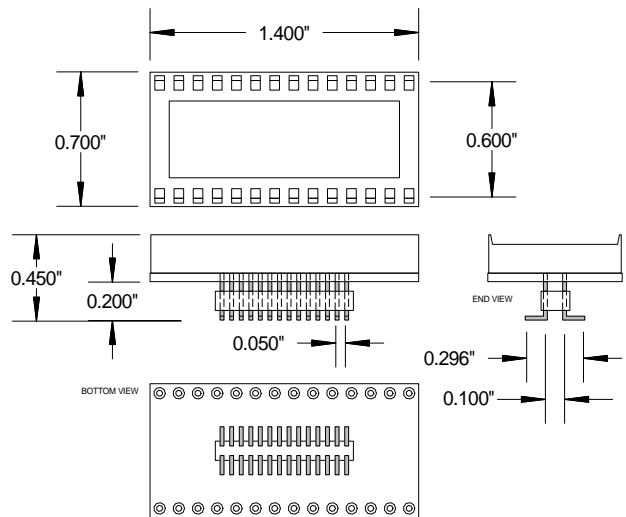

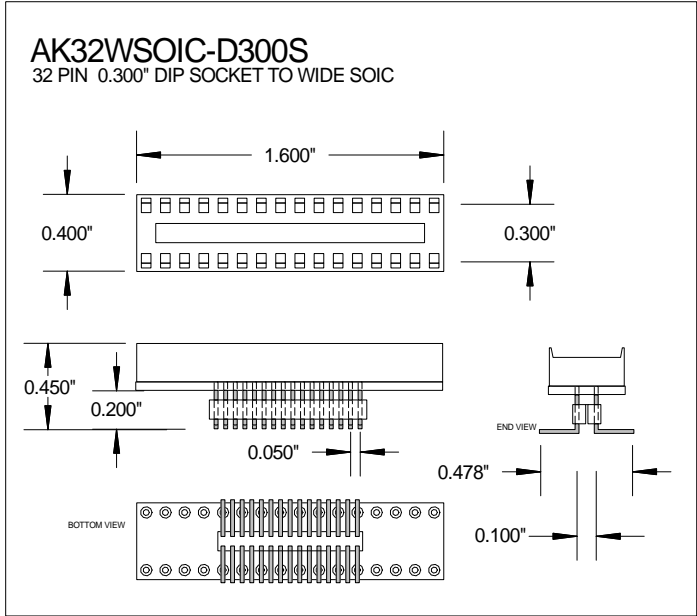
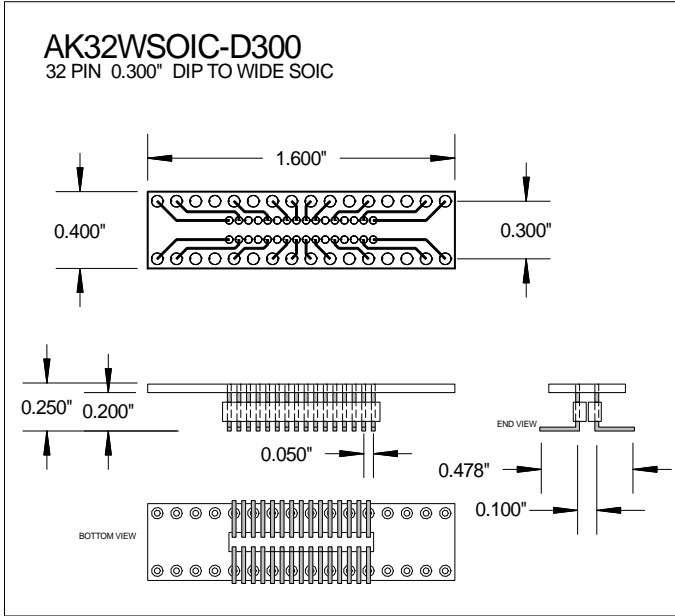
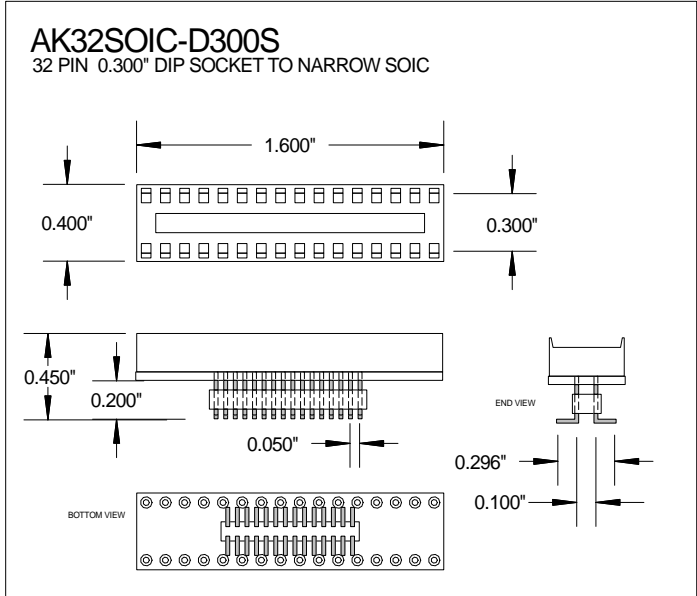
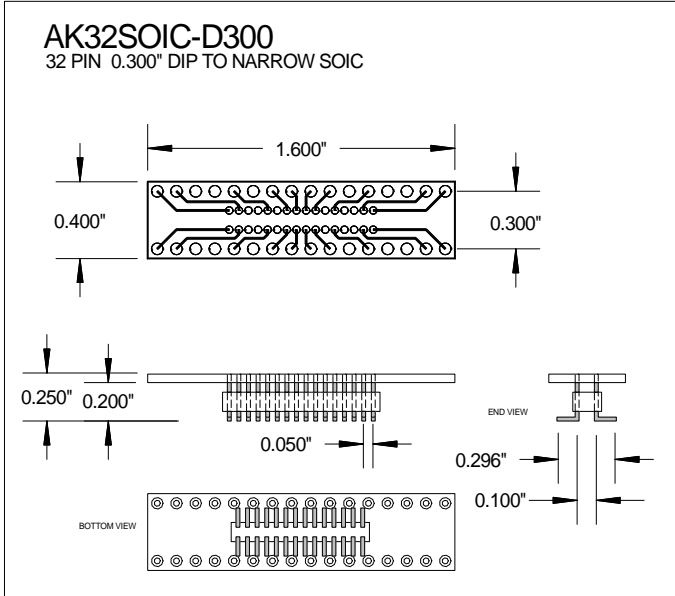
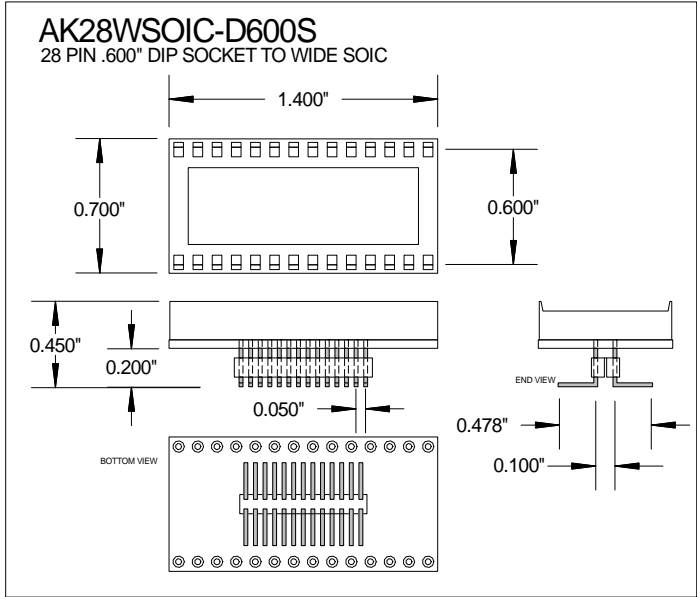
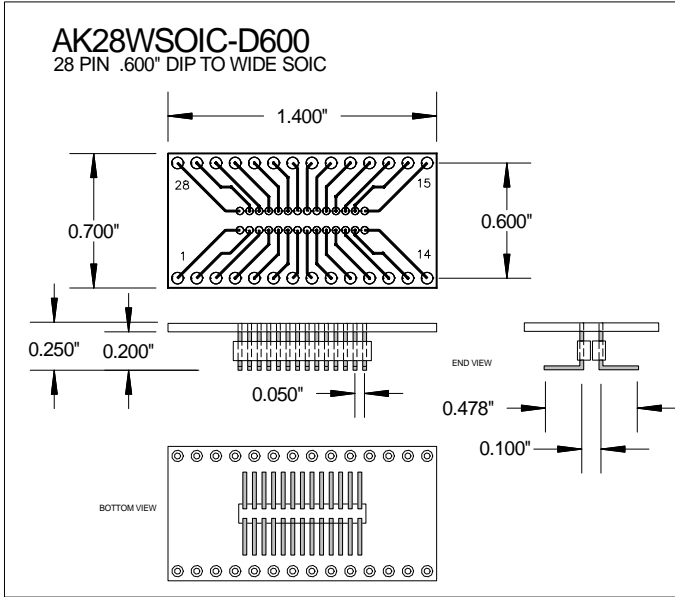

AK32SOIC-D600
32 PIN .600" DIP TO NARROW SOIC

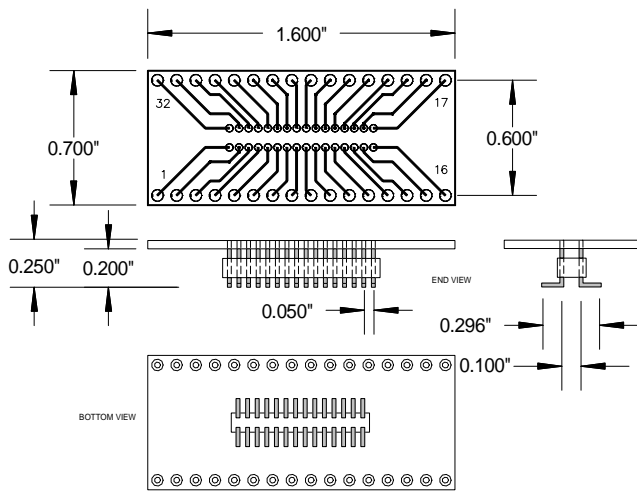

AK32SOIC-D600S
32 PIN .600" DIP SOCKET TO NARROW SOIC

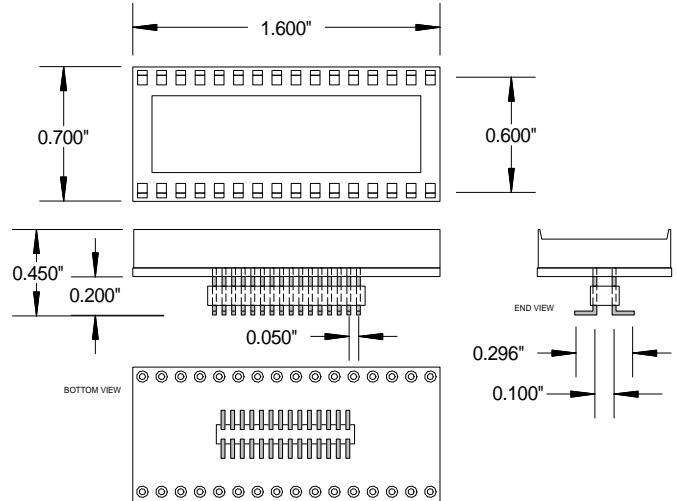

AK32WSOIC-D600
32 PIN .600" DIP TO WIDE SOIC

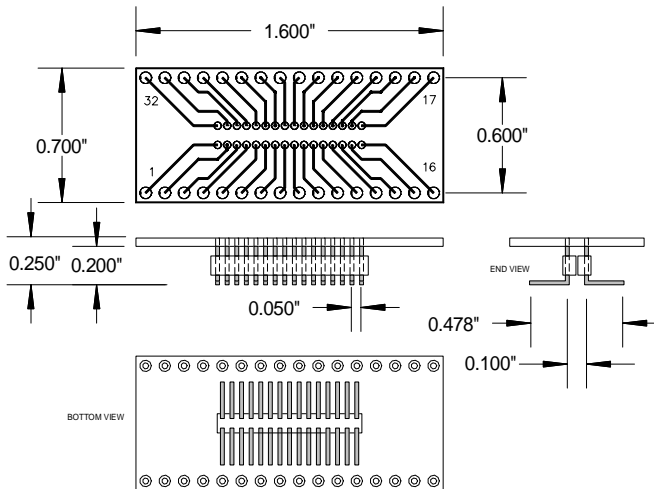

AK32WSOIC-D600S
32 PIN .600" DIP SOCKET TO WIDE SOIC

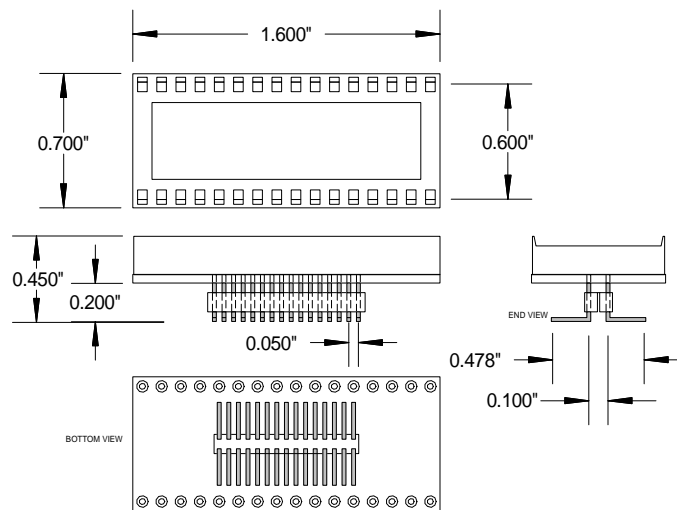

We can assemble your chips on to our adapter boards. Fully automated assembly and test at our Newburyport, Massachusetts facility.



No job to large or small.