

**Technical Data Sheet****Side View LEDs (Height 0.6mm)****99-116SUBP/S971/TR8****Features**

- Side view white LED.
- White SMT package.
- Lead frame package with individual 2 pins.
- Wide viewing angle.
- Soldering methods: IR reflow soldering.
- Pb-free.
- The product itself will remain within RoHS compliant version.

**Descriptions**

- Due to the package design, 99-116 has wide viewing angle , low power consumption and white LEDs are devices which are materialized by combing Blue LEDs and special phosphors . This feature makes the LED ideal for light guide application.

**Applications**

- LCD Back Light.
- Mobile phones .
- Indicators.
- Illuminations.
- Switch Lights.

**Device Selection Guide**

Chip	Emitted Color	Resin Color
Material		
InGaN	Pastel mint blue	Water Clear

Technical Data Sheet

Side View LEDs (Height 0.6mm)

**99-116SUBP/S971/TR8**

Package Outline Dimensions

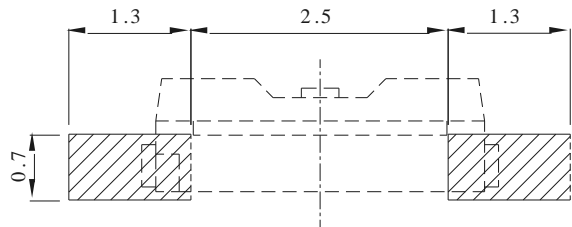
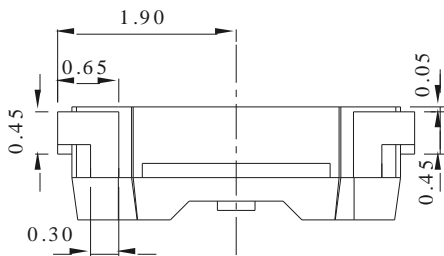
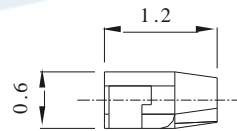
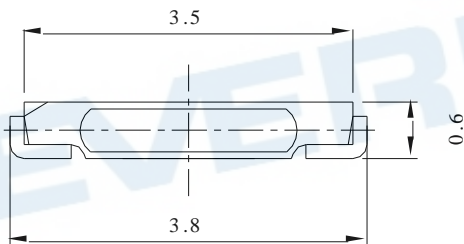
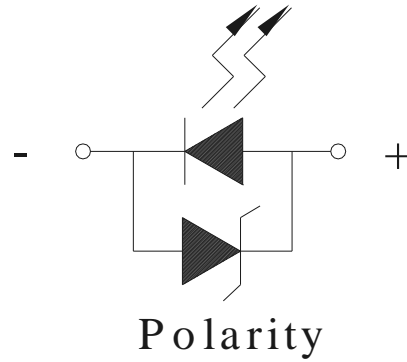
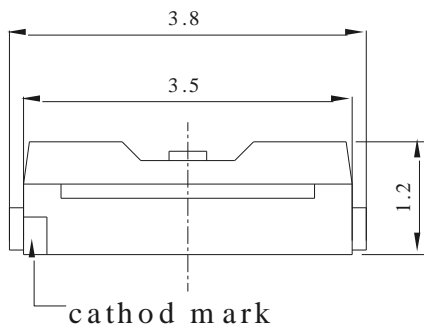

Recommended soldering pad design

**Note:**

Tolerances Unless Dimension  $\pm 0.1\text{mm}$ , Unit = mm



## Technical Data Sheet

## Side View LEDs (Height 0.6mm)

**99-116SUBP/S971/TR8****Absolute Maximum Ratings (Ta=25°C)**

Parameter	Symbol	Rating	Unit
Reverse Voltage	V <sub>R</sub>	5	V
Forward Current	I <sub>F</sub>	30	mA
Peak Forward Current (Duty 1/10 @10ms)	I <sub>FP</sub>	100	mA
Power Dissipation	P <sub>d</sub>	110	mW
Electrostatic Discharge(HBM)	ESD	2000	V
Operating Temperature	T <sub>opr</sub>	-40 ~ +85	°C
Storage Temperature	T <sub>stg</sub>	-40 ~ +90	°C
Soldering Temperature	T <sub>sol</sub>	Reflow Soldering : 260 °C for 10 sec. Hand Soldering : 350 °C for 3 sec.	

**Electro-Optical Characteristics (Ta=25°C)**

Parameter	Symbol	Min.	Typ.	Max.	Unit	Condition
Luminous Intensity	I <sub>v</sub>	225	-----	360	mcd	I <sub>F</sub> =5mA
Viewing Angle	2θ <sub>1/2</sub>	-----	110	-----	deg	I <sub>F</sub> =5mA
Forward Voltage	V	2.70	-----	3.70	V	I <sub>F</sub> =5mA

**Note:**

- 1.Tolerance of Luminous Intensity: ±11%
- 2.Tolerance of Forward Voltage: ±0.05V



## Technical Data Sheet

## Side View LEDs (Height 0.6mm)

99-116SUBP/S971/TR8

## Bin Range of Luminous Intensity

Bin Code	Min.	Max.	Unit	Conduction
S2	225	285	mcd	I <sub>F</sub> =5mA
T1	285	360		

## Bin Range of Forward Voltage

Bin Code	Min.	Max.	Unit	Conduction
10	2.70	2.90	V	I <sub>F</sub> =5mA
11	2.90	3.10		
12	3.10	3.30		
13	3.30	3.50		
14	3.50	3.70		

## Note:

- 1.Tolerance of Luminous Intensity:  $\pm 11\%$
- 2.Tolerance of Forward Voltage:  $\pm 0.05V$



## Technical Data Sheet

## Side View LEDs (Height 0.6mm)

99-116SUBP/S971/TR8

## Bin Range of Chromaticity Coordinates

Bin Code	CIE_x	CIE_y	Bin Code	CIE_x	CIE_y
A	0.185	0.280	B	0.211	0.380
	0.194	0.280		0.202	0.369
	0.206	0.330		0.189	0.330
	0.189	0.330		0.206	0.330
	0.185	0.318		0.218	0.380
	0.185	0.280		0.211	0.380
C	0.194	0.280	D	0.218	0.380
	0.202	0.280		0.206	0.330
	0.220	0.315		0.220	0.330
	0.220	0.330		0.220	0.380
	0.206	0.330		0.218	0.380
	0.194	0.280		-----	-----

**Note:**Tolerance of Chromaticity Coordinates:  $\pm 0.01$

Technical Data Sheet

Side View LEDs (Height 0.6mm)

99-116SUBP/S971/TR8

The C.I.E. 1931 Chromaticity Diagram

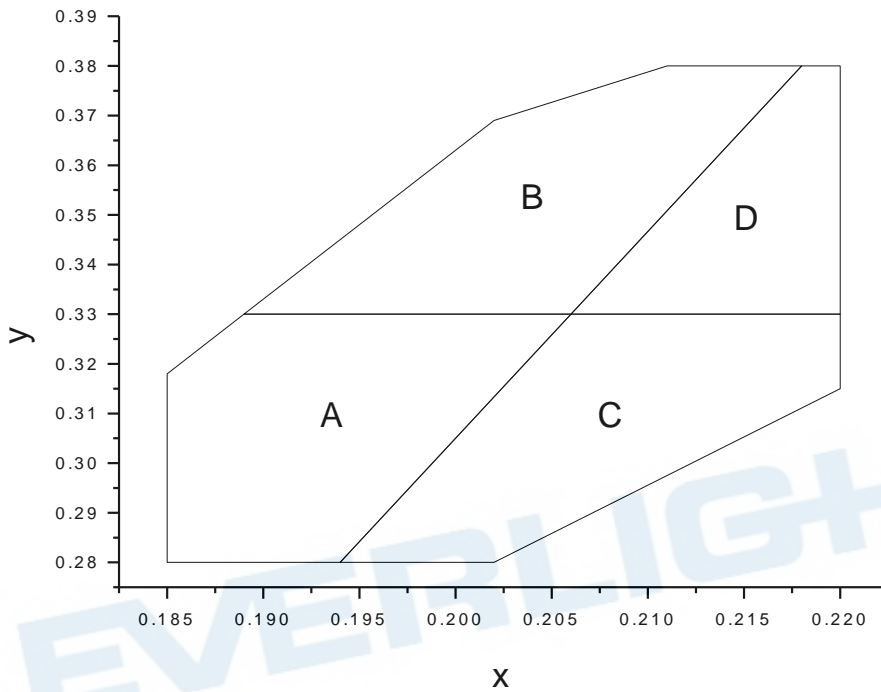

Technical Data Sheet

Side View LEDs (Height 0.6mm)

**99-116SUBP/S971/TR8**

Typical Electro-Optical Characteristics Curves

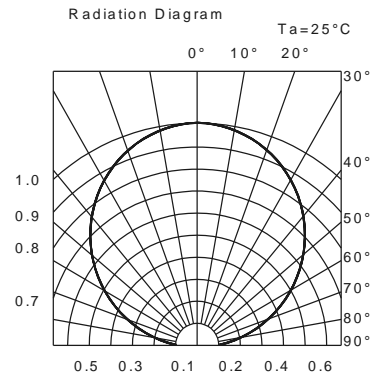
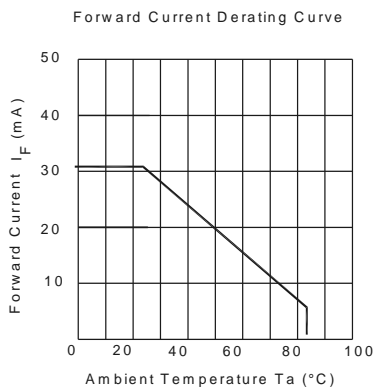
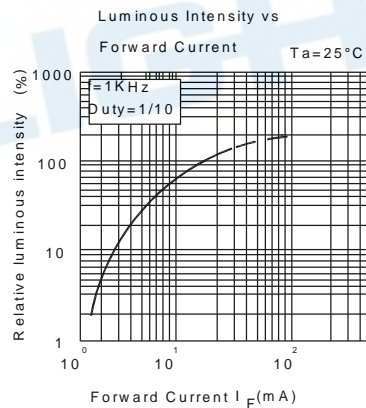
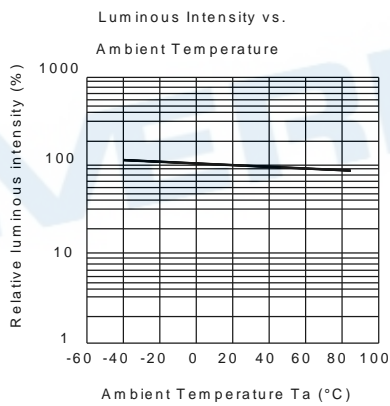
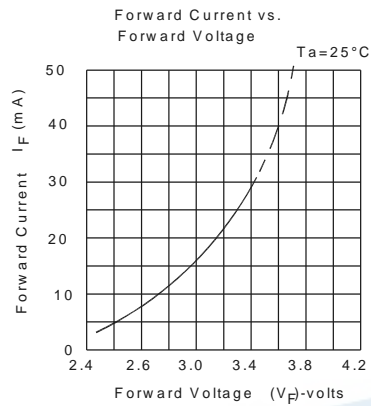
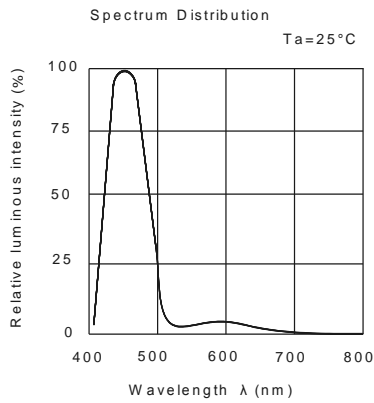



Technical Data Sheet

Side View LEDs (Height 0.6mm)

99-116SUBP/S971/TR8

Label Explanation

- CAT: Luminous Intensity Rank
- HUE: Chromaticity Coordinates
- REF: Forward Voltage Rank

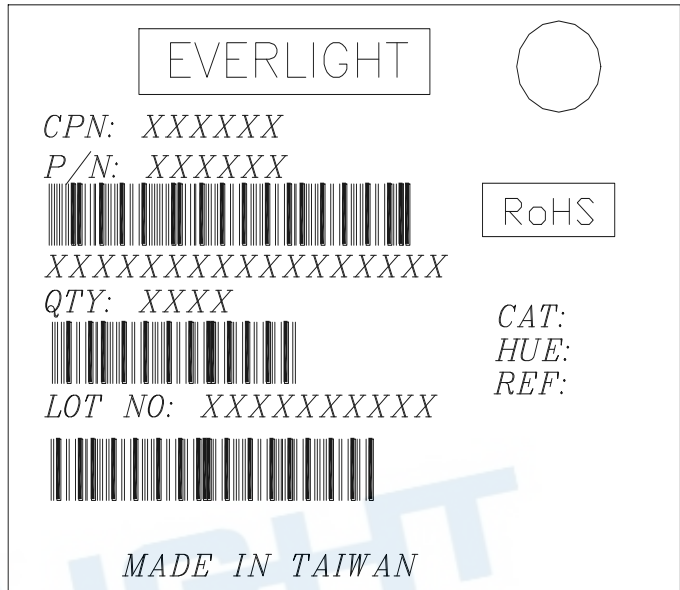

Reel Dimensions

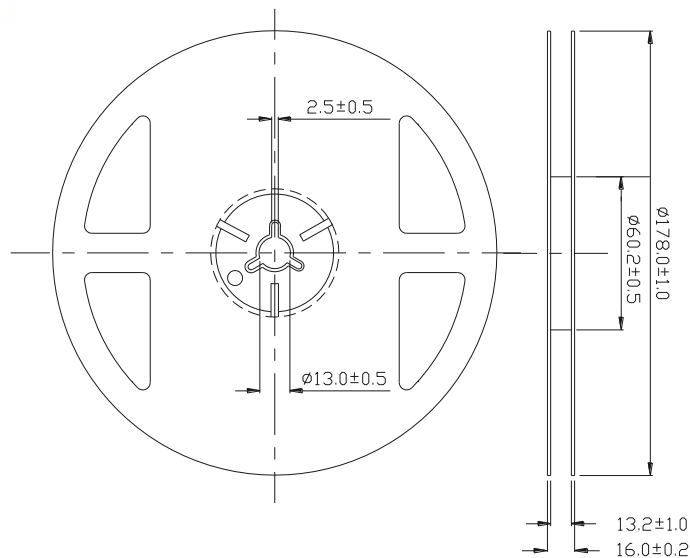

Note:

The tolerances unless mentioned is ±0.1mm, Unit = mm



Technical Data Sheet

Side View LEDs (Height 0.6mm)

**99-116SUBP/S971/TR8**

**Carrier Tape Dimensions: Loaded Quantity 2000 pcs per reel.**

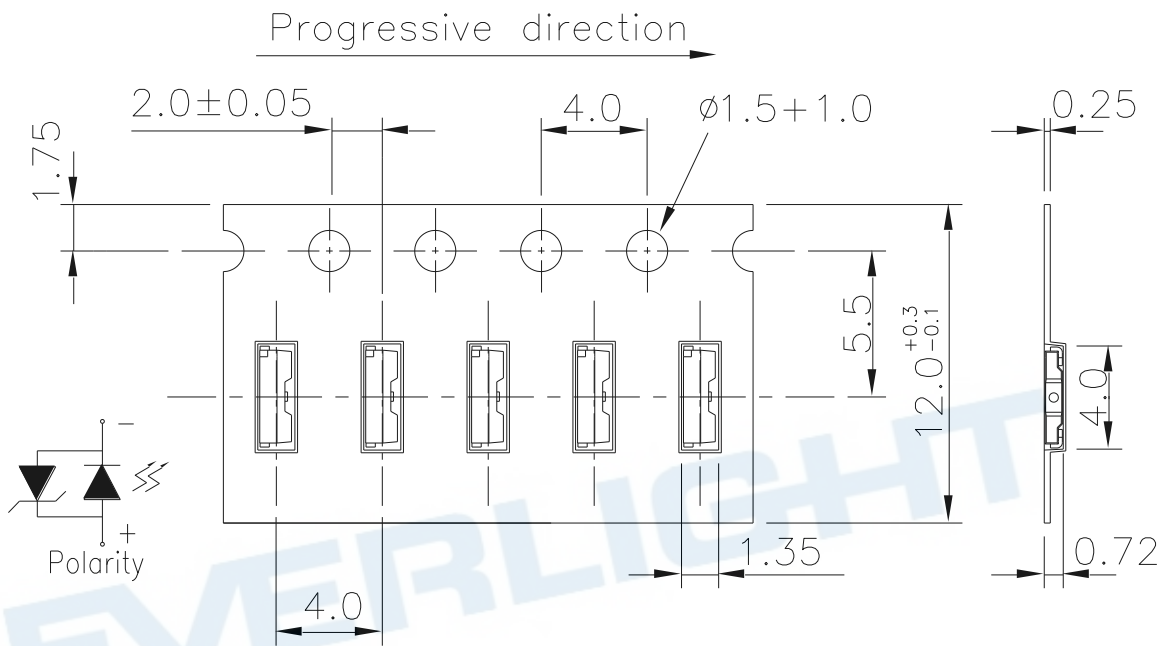

**Note:**

Tolerances Unless Dimension  $\pm 0.1\text{mm}$  Unit = mm

**Moisture Resistant Packaging**

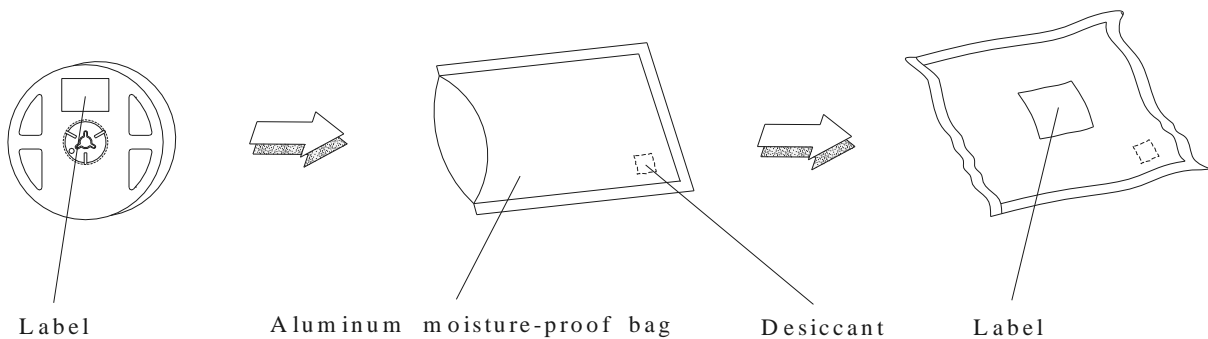

**Technical Data Sheet****Side View LEDs (Height 0.6mm)****99-116SUBP/S971/TR8****Reliability Test Items And Conditions**

The reliability of products shall be satisfied with items listed below.

Confidence level : 90%

LTPD : 10%

No.	Items	Test Condition	Test Hours/Cycles	Sample Size	Ac/Re
1	Reflow Soldering	Temp. : 260°C±5°C Min. 5 sec.	6 Min.	22 PCS	0/1
2	Temperature Cycle	H : +100°C 15min ↓ 5 min L : -40°C 15min	300 Cycles	22 PCS.	0/1
3	Thermal Shock	H : +100°C 5min ↓ 10 sec L : -10°C 5min	300 Cycles	22 PCS.	0/1
4	High Temperature Storage	Temp. : 100°C	1000 Hrs.	22 PCS.	0/1
5	Low Temperature Storage	Temp. : -40°C	1000 Hrs.	22 PCS.	0/1
6	DC Operating Life	I <sub>F</sub> = 5 mA / 25°C	1000 Hrs.	22 PCS.	0/1
7	High Temperature / High Humidity	85°C/85%RH	1000 Hrs.	22 PCS.	0/1

**Technical Data Sheet****Side View LEDs (Height 0.6mm)****99-116SUBP/S971/TR8****Precautions For Use****1. Over-current-proof**

Customer must apply resistors for protection, otherwise slight voltage shift will cause big current change ( Burn out will happen ).

**2. Storage**

2.1 Do not open moisture proof bag before the products are ready to use.

2.2 Before opening the package: The LEDs should be kept at 30°C or less and 90%RH or less.

2.3 After opening the package: The LED's floor life is 1 year under 30°C or less and 60% RH or less.

If unused LEDs remain, it should be stored in moisture proof packages.

2.4 If the moisture absorbent material (silica gel) has faded away or the LEDs have exceeded the storage time, baking treatment should be performed using the following conditions.

Baking treatment : 60±5°C for 24 hours.

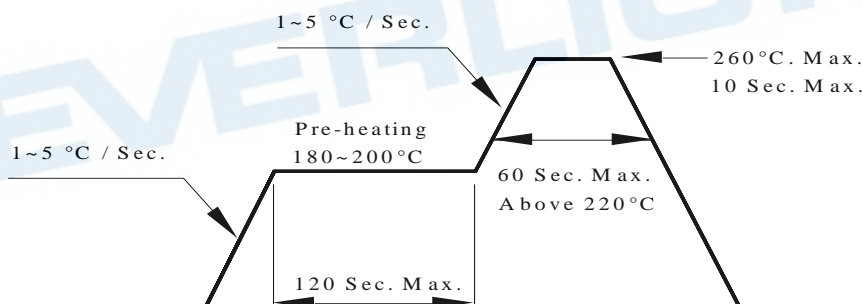
**3. Soldering Condition****3.1 Pb-free solder temperature profile**

3.2 Reflow soldering should not be done more than two times.

3.3 When soldering, do not put stress on the LEDs during heating.

3.4 After soldering, do not warp the circuit board.

**4.Soldering Iron**

Each terminal is to go to the tip of soldering iron temperature less than 350°C for 3 seconds within once in less than the soldering iron capacity 25W. Leave two seconds and more intervals, and do soldering of each terminal. Be careful because the damage of the product is often started at the time of the hand solder.

**Technical Data Sheet****Side View LEDs (Height 0.6mm)****99-116SUBP/S971/TR8****5.Repairing**

Repair should not be done after the LEDs have been soldered. When repairing is unavoidable, a double-head soldering iron should be used (as below figure). It should be confirmed beforehand whether the characteristics of the LEDs will or will not be damaged by repairing.

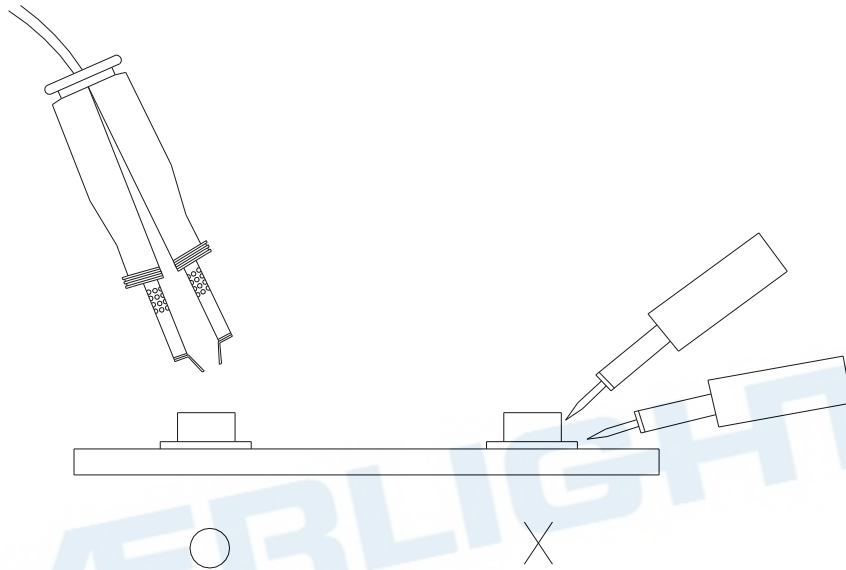
**6. Handling Indications**

During processing, mechanical stress on the surface should be minimized as much as possible. Sharp objects of all types should not be used to pierce the sealing compound

**EVERLIGHT ELECTRONICS CO., LTD.**

Office: No 25, Lane 76, Sec 3, Chung Yang Rd,  
Tucheng, Taipei 236, Taiwan, R.O.C

Tel: 886-2-2267-2000, 2267-9936

Fax: 886-2267-6244, 2267-6189, 2267-6306

<http://www.everlight.com>