

Cavity Bandpass Filters

50Ω DC to 15 GHz



The Big Deal

- Very low insertion loss with excellent power handling
- Very fast roll-off with wide stopband
- Passbands up to 15 GHz
- Stopbands up to 20 GHz

Product Overview

Mini-Circuits' cavity filters are designed by implementing resonant structures with very high Q and are ideal for narrow-band, high-selectivity applications. These designs can provide bandwidths as narrow as 1% with very high selectivity and excellent low noise floor. Low insertion loss combined with excellent power handling makes them well-suited for transmitter and receiver front end. Advanced filter design and construction enables stopband width greater than 3x the center frequency.

Mini-Circuits' cavity filters feature a special protective assembly to prevent accidental de-tuning that would otherwise require expensive replacement or return to factory for re-tuning. Precise machining allows realization of cavity filters with small form factors for applications where size is critical. Excellent repeatability across units is achieved through precise tuning and process control.

Key Features

Feature	Advantages
Low insertion loss	Low signal loss results in better SNR in receiver front end and better power delivery to antenna in transmitter
Fast roll-off	Higher selectivity results in better adjacent channel rejection and dynamic range
Wide stopband	Wide spur free band results in better receiver sensitivity
High power handling	Well suited for transmitter application
Protective assembly	Prevents accidental de-tuning of precisely tuned resonant circuit

Notes

- A. Performance and quality attributes and conditions not expressly stated in this specification document are intended to be excluded and do not form a part of this specification document.
B. Electrical specifications and performance data contained in this specification document are based on Mini-Circuit's applicable established test performance criteria and measurement instructions.
C. The parts covered by this specification document are subject to Mini-Circuits standard limited warranty and terms and conditions (collectively, "Standard Terms"); Purchasers of this part are entitled to the rights and benefits contained therein. For a full statement of the Standard Terms and the exclusive rights and remedies thereunder, please visit Mini-Circuits' website at www.minicircuits.com/MCLStore/terms.jsp



Bandpass Filter

ZVBP-2450+

50Ω 2400 to 2500 MHz



Features

- Low insertion loss
- High rejection
- Connectorized package

CASE STYLE: QT2302
Connectors SMA-F Model ZVBP-2450-S+

Electrical Specifications at 25°C

Parameter	F#	Frequency (MHz)	Min.	Typ.	Max.	Unit	
Pass Band	Center Frequency	-	-	2450	-	MHz	
	Insertion Loss	F1-F2	2400 - 2500	-	0.7	1.3	dB
	VSWR	F1-F2	2400 - 2500	-	1.3	1.5	:1
Stop Band, Lower	Insertion Loss	DC-F3	DC - 2120	70	80	-	dB
	VSWR	F3-F4	2120 - 2260	40	55	-	dB
		DC-F4	DC - 2260	-	20	-	:1
Stop Band, Upper	Insertion Loss	F5-F6	2635 - 2780	40	55	-	dB
		F6-F7	2780 - 4000	70	80	-	dB
	VSWR	F7-F8	4000 - 6000	-	40	-	dB
		F5-F8	2635 - 6000	-	20	-	:1

Applications

- ISM applications
- Radio location
- Mobile communication

Functional Schematic

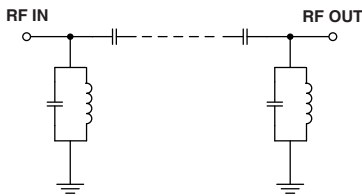

Maximum Ratings

Operating Temperature	-40°C to 85°C
Storage Temperature	-55°C to 100°C
RF Power Input	15 W max.

Permanent damage may occur if any of these limits are exceeded.

Typical Performance Data at 25°C

Frequency (MHz)	Insertion Loss (dB)	VSWR (:1)	Frequency (MHz)	Group Delay (nsec)
100	83.71	1610.03	2400	12.88
500	84.73	200.31	2405	11.71
1000	103.04	235.79	2410	11.02
2000	89.21	307.96	2415	10.52
2120	79.68	298.21	2420	10.09
2260	55.49	223.22	2425	9.74
2340	29.47	97.02	2430	9.48
2358	19.99	54.14	2435	9.34
2375	8.46	12.63	2440	9.29
2382	3.79	4.48	2445	9.29
2400	0.71	1.17	2450	9.30
2450	0.55	1.04	2455	9.31
2500	0.74	1.05	2460	9.33
2515	3.44	3.86	2465	9.40
2540	19.92	42.96	2470	9.55
2558	29.27	71.20	2475	9.81
2635	54.54	147.61	2480	10.15
2780	78.86	212.04	2485	10.57
4000	96.12	200.31	2490	11.10
6000	103.54	204.08	2500	13.25

Typical Frequency Response

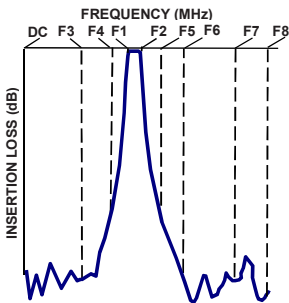

+RoHS Compliant

The +Suffix identifies RoHS Compliance. See our web site for RoHS Compliance methodologies and qualifications

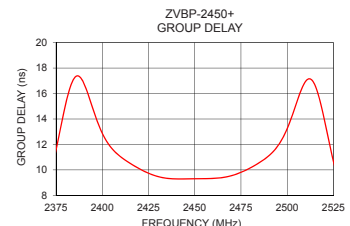
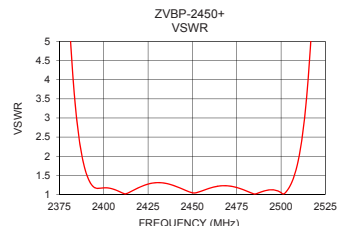
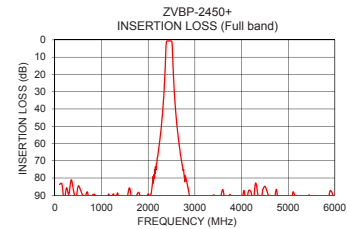
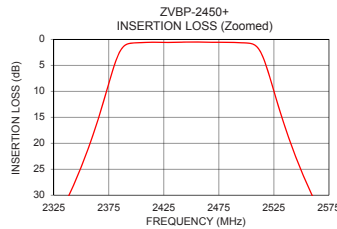

Notes

- Performance and quality attributes and conditions not expressly stated in this specification document are intended to be excluded and do not form a part of this specification document.
- Electrical specifications and performance data contained in this specification document are based on Mini-Circuit's applicable established test performance criteria and measurement instructions.
- The parts covered by this specification document are subject to Mini-Circuits standard limited warranty and terms and conditions (collectively, "Standard Terms"); Purchasers of this part are entitled to the rights and benefits contained therein. For a full statement of the Standard Terms and the exclusive rights and remedies thereunder, please visit Mini-Circuits' website at www.minicircuits.com/MCLStore/terms.jsp



Coaxial Connections

PORT - 1	SMA-FEMALE
PORT - 2	SMA-FEMALE

Outline Drawing

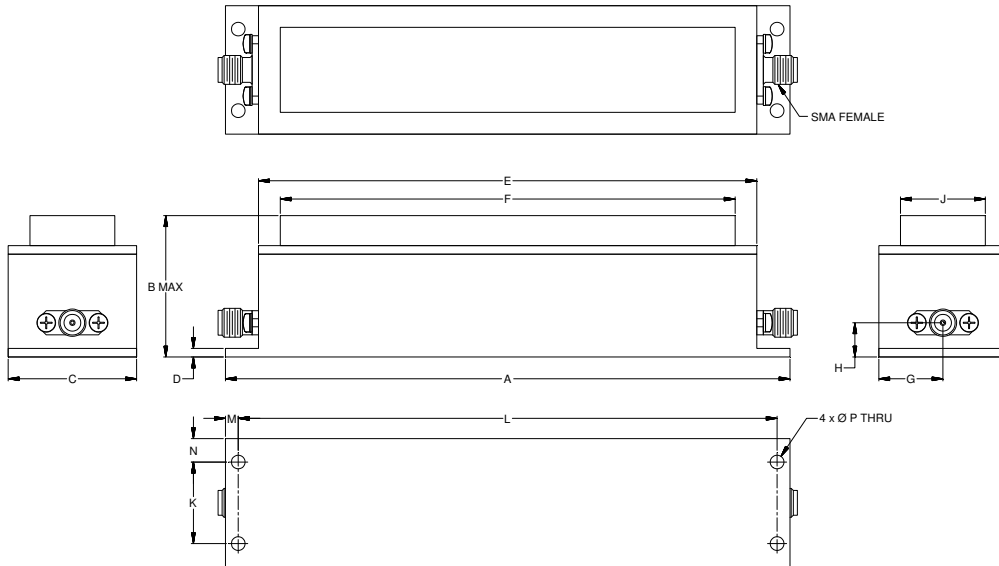

Outline Dimensions (inch / mm)

A	B	C	D	E	F	G	H
5.20	1.38	1.18	.08	4.59	4.19	.59	.31
132.00	35.00	30.00	2.00	116.50	106.34	15.00	8.00
J	K	L	M	N	P	Wt.	
.78	.750	4.960	.12	.22	.126	grams	
19.84	19.05	125.98	3.01	5.47	3.20	184	

Notes

- A. Performance and quality attributes and conditions not expressly stated in this specification document are intended to be excluded and do not form a part of this specification document.
- B. Electrical specifications and performance data contained in this specification document are based on Mini-Circuit's applicable established test performance criteria and measurement instructions.
- C. The parts covered by this specification document are subject to Mini-Circuits standard limited warranty and terms and conditions (collectively, "Standard Terms"); Purchasers of this part are entitled to the rights and benefits contained therein. For a full statement of the Standard Terms and the exclusive rights and remedies thereunder, please visit Mini-Circuits' website at www.minicircuits.com/MCLStore/terms.jsp

