



Features

- GPS Receive Front-End Gain = 37 dB
- Meets IMD Tests with Three Gain States/Two Logic Control Lines
- Adjustable Mixer and LNA Bias Current
- Selectable Divide-by-2 Prescaler
- Integrated TX LO Buffer Amplifier

Applications

- CDMA/Cellular/PCS/GPS Handsets
- JCDMA/GPS Handsets
- CDMA Modem/Data Cards
- Commercial and Consumer Systems
- Portable Battery-Powered Equipment

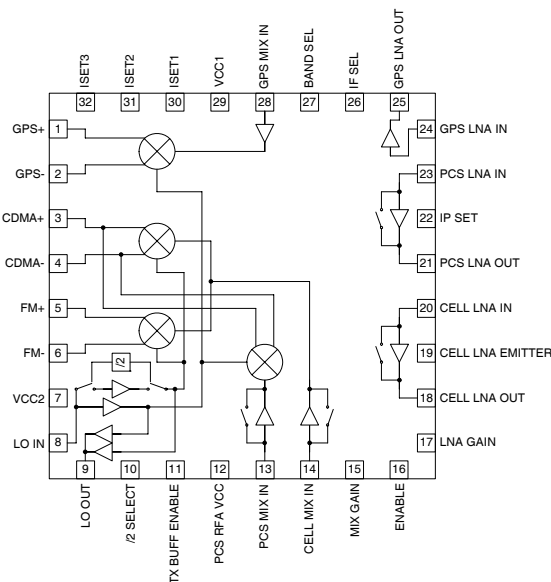

Functional Block Diagram

Product Description

The RF2498 is a high performance CDMA tri-band/quad-mode integrated LNA/mixer with GPS capability. The device is designed to meet all IS-98 sensitivity, intermodulation and single-tone requirements. The RF2498 integrates the tri-band LNA/downconverters with 27.5dB of gain control for the cellular band and 29dB for the PCS band. The RF2498 is designed for three state gain control solutions for IS-98 IMD testing. The device offers a dedicated GPS LNA/mixer with 37dB of gain. Additionally, a divide-by-2 prescaler to allow the use of either a single- or dual-band VCO is integrated. There is also a TX LO buffer. The design is flexible, in that the bias currents may be set using off-chip current reference resistors for the mixer and LNA blocks. The device is packaged in a plastic, 5mmx5mm, leadless chip carrier.

Ordering Information

RF2498 Tri-Band/Quad-Mode CDMA/GPS Low Noise Amplifier/Mixer
 RF2498PCBA-41X Fully Assembled Evaluation Board

Optimum Technology Matching® Applied

- | | | | |
|--------------------------------------|---|-------------------------------------|-----------------------------------|
| <input type="checkbox"/> GaAs HBT | <input checked="" type="checkbox"/> SiGe BiCMOS | <input type="checkbox"/> GaAs pHEMT | <input type="checkbox"/> GaN HEMT |
| <input type="checkbox"/> GaAs MESFET | <input type="checkbox"/> Si BiCMOS | <input type="checkbox"/> Si CMOS | |
| <input type="checkbox"/> InGaP HBT | <input type="checkbox"/> SiGe HBT | <input type="checkbox"/> Si BJT | |

RF MICRO DEVICES®, RFMD®, Optimum Technology Matching®, Enabling Wireless Connectivity™, PowerStar®, POLARIS™ TOTAL RADIO™ and UltimateBlue™ are trademarks of RFMD, LLC. BLUETOOTH is a trademark owned by Bluetooth SIG, Inc., U.S.A. and licensed for use by RFMD. All other trade names, trademarks and registered trademarks are the property of their respective owners. ©2006, RF Micro Devices, Inc.

Absolute Maximum Ratings

Parameter	Rating	Unit
Supply Voltage	-0.5 to +5.0	V _{DC}
Input LO and RF Levels	+6	dBm
Operating Ambient Temperature	-40 to +85	°C
Storage Temperature	-40 to +150	°C



Caution! ESD sensitive device.

Exceeding any one or a combination of the Absolute Maximum Rating conditions may cause permanent damage to the device. Extended application of Absolute Maximum Rating conditions to the device may reduce device reliability. Specified typical performance or functional operation of the device under Absolute Maximum Rating conditions is not implied.

RoHS status based on EU Directive 2002/95/EC (at time of this document revision).

The information in this publication is believed to be accurate and reliable. However, no responsibility is assumed by RF Micro Devices, Inc. ("RFMD") for its use, nor for any infringement of patents, or other rights of third parties, resulting from its use. No license is granted by implication or otherwise under any patent or patent rights of RFMD. RFMD reserves the right to change component circuitry, recommended application circuitry and specifications at any time without prior notice.

Parameter	Specification			Unit	Condition
	Min.	Typ.	Max.		
Overall					T = 25 °C, V _{CC} = 2.75V
RF Frequency Range		800 to 900		MHz	
		1500 to 2200		MHz	
		1575.42		MHz	GPS band
IF Frequency Range	0.1		400	MHz	
Power Supply					
Supply Voltage	2.65	2.75	3.15	V	
Logic High	1.8			V	
Logic Low			0.4	V	
Power Down Current			10	µA	ENABLE = 0
Cellular Band					Freq = 869 MHz to 894 MHz
JCDMA Band					Freq = 832 MHz to 870 MHz
LNA (On)					LNA 50Ω match
Gain	13.5	15.0	16.5	dB	IPSET = 1
	13.0	14.5	16.0	dB	IPSET = 0
Noise Figure		1.1	1.3	dB	IPSET = 1
		1.0	1.2	dB	IPSET = 0
Input IP3	+9.0	+11.0		dBm	IPSET = 1
	+5.0	+9.0		dBm	IPSET = 0
Current		6.5		mA	IPSET = 1
		4.5		mA	IPSET = 0
Isolation		23		dB	
LNA (Off)					
Gain	-4.0	-2.5	-1.8	dB	
Noise Figure		2.5	4.0	dB	
Input IP3	+20.0	+25.0		dBm	
Current		0		mA	
Isolation		2.5		dB	
Mixer - CDMA/JCDMA					LO IN = -4 dBm See note 1 and 2.
Gain	11.5	13.0	14.5	dB	Mixer Preamp ON
	1.5	3.0	4.5	dB	Mixer Preamp OFF
Noise Figure		7.5	8.5	dB	Mixer Preamp ON
		14.0	16.0	dB	Mixer Preamp OFF
Input IP3	+1.0	+3.5		dBm	Mixer Preamp ON

	+11.0	+13.0		dBm	Mixer Preamp OFF
Current		18.5		mA	Mixer Preamp ON/Mixer/LO Input Amps
		13.5		mA	Mixer Preamp OFF/Mixer/LO Input Amps

Parameter	Specification			Unit	Condition
	Min.	Typ.	Max.		
Mixer - CDMA/JCDMA, cont.					LO IN = -4 dBm See note 1 and 2.
LO to RF Isolation	36			dB	Mixer Preamp ON
				dB	Mixer Preamp OFF
LO Frequency Range	600		2300	MHz	High and Low Side LO Injection. See note 3 and 4.
IF Frequency Range	0.1	183.6	400	MHz	Typical IF frequencies: 85.38 MHz, 109.80 MHz, 111.85 MHz, 183.6 MHz
Mixer - FM					LO IN = -4 dBm See note 1 and 2.
Gain	11.5	13.0	14.5	dB	Mixer Preamp ON
	1.5	3.0	4.5	dB	Mixer Preamp OFF
Noise Figure		7.5	8.5	dB	Mixer Preamp ON
		14.0	16.0	dB	Mixer Preamp OFF
Input IP3	+1.5	+3.5		dBm	Mixer Preamp ON
	+11.0	+14.0		dBm	Mixer Preamp OFF
Current		18.5		mA	Mixer Preamp ON/Mixer/LO Input Amps
		13.5		mA	Mixer Preamp OFF/Mixer/LO Input Amps
LO to RF Isolation	36			dB	Mixer Preamp ON
				dB	Mixer Preamp OFF
LO Frequency Range	600		2300	MHz	High and Low Side LO Injection See note 3 and 4.
IF Frequency Range	0.1	183.6	400	MHz	Typical IF frequencies: 85.38 MHz, 109.80 MHz, 111.85 MHz, 183.6 MHz
Other					
LO-IF Isolation	30			dB	
RF-IF Isolation	40			dB	
LNA Out to Mixer In Isolation	40			dB	
LO-LNA In Isolation, Any State	35			dB	
US PCS Band					Freq = 1930 MHz to 1990 MHz
Korean PCS Band					Freq = 1840 MHz to 1870 MHz
LNA (On)					LNA 50Ω match
Gain	13.5	15.5	17.5	dB	IPSET = 1
	13.0	15.0	16.5	dB	IPSET = 0
Noise Figure		1.5	1.8	dB	IPSET = 1
		1.4	1.7	dB	IPSET = 0
Input IP3	+8.0	+12.0		dBm	IPSET = 1
	-2.0	+4.0		dBm	IPSET = 0
Current		6.5		mA	IPSET = 1
		4.5		mA	IPSET = 0
Isolation		20		dB	
LNA (Off)					
Gain	-6	-4		dB	
Noise Figure		4	6	dB	
Input IP3	+20.0	+26.0		dBm	
Current		0		mA	
Isolation		4		dB	

Parameter	Specification			Unit	Condition
	Min.	Typ.	Max.		
Mixer					LO IN = -4 dBm See note 1.
Gain	12.0	14.0	15.5	dB	Mixer Preamp ON
	2.5	4.5	6.5	dB	Mixer Preamp OFF
Noise Figure		7.0	8.5	dB	Mixer Preamp ON
		15	17	dB	Mixer Preamp OFF
Input IP3	+1.5	+5.0		dBm	Mixer Preamp ON
	+11.0	+13.0		dBm	Mixer Preamp OFF
Current		19.0		mA	Mixer Preamp ON/Mixer/LO Input Amps
		14.0		mA	Mixer Preamp OFF/Mixer/LO Input Amps
LO to RF Isolation	36			dB	Mixer Preamp ON
	30			dB	Mixer Preamp OFF
LO Frequency Range	1600		2400	MHz	High and Low Side LO Injection
IF Frequency Range	0.1	183.6	400	MHz	Typical IF frequencies: 183.6MHz, 210.38MHz, 220.38MHz
Other					
LO-IF Isolation	36			dB	
RF-IF Isolation	40			dB	
LNA Out to Mixer In Isolation	30	40		dB	
LO-LNA In Isolation, Any State	35			dB	
GPS Band					Freq = 1575.42MHz
LNA (On)					LNA 50Ω match
Gain	17.0	19.0		dB	IPSET = 1
	16	18		dB	IPSET = 0
Noise Figure		1.3	1.7	dB	IPSET = 1
		1.25	1.7	dB	IPSET = 0
Input IP3	+1.0	+5.0		dBm	IPSET = 1
	-5.0	-1.0		dBm	IPSET = 0
Current		6.5		mA	IPSET = 1
		4.5		mA	IPSET = 0
Isolation		20		dB	
Mixer					LO IN = -4 dBm See note 1.
Gain	16	18		dB	
Noise Figure		5.5		dB	High Side LO Injection.
		7.0		dB	Low Side LO Injection.
Input IP3	-7.5	-5.5		dBm	
Current		15.5		mA	Preamp/Mixer/LO Input Amps
LO to RF Isolation				dB	
LO Frequency Range	1350		1800	MHz	High and Low Side LO Injection
LO Input Power Range	-10	-4	0	dBm	
IF Frequency Range	0.1	183.6	400	MHz	Typical IF frequencies: 183.6MHz, 210.38MHz, 220.38MHz
Other					
LO-IF Isolation	36			dB	
RF-IF Isolation	40			dB	
LNA Out to Mixer In Isolation	30	40		dB	
LO-LNA In Isolation, Any State	35			dB	

Parameter	Specification			Unit	Condition
	Min.	Typ.	Max.		
Control Lines					
Input Capacitance			1	pF	BAND SEL, IF SEL, IP SET, LNA GAIN, ENABLE, MIX GAIN, TX BUFF ENABLE, /2 SELECT
Local Oscillator Input					
Cellular - CDMA/FM/JCDMA					
Input Power	-10	-4	0	dBm	
Input Frequency	600		1078	MHz	See note 3. High and Low side injection.
	1200		2156	MHz	See note 4. High and Low side injection.
PCS					
Input Power	-10	-4	0	dBm	
Input Frequency	1600		2300	MHz	High and Low Side LO Injection.
GPS					
Input Power	-10	-4	0	dBm	
Input Frequency	1350		1800	MHz	High and Low Side LO Injection.
TX (Local Oscillator) Buffer					
Cellular - CDMA/FM/JCDMA					
Output Power	-11	-8		dBm	Single-ended 50Ω load
Output Frequency	600		1078	MHz	See note 3. High and Low Side LO Injection.
Output Power	-11	-6.5			Single-ended 50Ω load
Output Frequency	1200		2156	MHz	See note 4. High and Low Side LO Injection.
Current Consumption		2		mA	
PCS					
Output Power	-11	-8		dBm	Single-ended 50Ω load
Output Frequency	1600		2300	MHz	High and Low Side LO Injection
Current Consumption		2		mA	

NOTE 1. Mixer performance can be changed with external IF load/tuning.

NOTE 2. Specifications apply for conditions of LO Divider enabled or disabled.

NOTE 3. LO Divider disabled. LO Divider disabled logic conditions:

A) BAND SELECT=1; /2 SELECT=Immaterial.B) BAND SELECT=0; /2 SELECT=1

NOTE 4. LO Divider enabled. LO Divider enabled logic conditions:

A) BAND SELECT=0; /2 SELECT=0

Evaluation Board Current Measurement

	BAND SEL	IF SEL	ENABLE	LNA GAIN	MIX GAIN	IP SET	TX BUFF ENABLE	/2 SELECT	IDC (mA)
CDMA Cellular- High IIP3 LNA Mode*									
LNA On, Mixer Preamp On, TX Buffer Off, /2 Off	0	1	1	1	1	1	0	1	27.0
LNA On, Mixer Preamp Off, TX Buffer Off, /2 Off	0	1	1	1	0	1	0	1	22.0
LNA Bypassed, Mixer Preamp On, TX Buffer Off, /2 Off	0	1	1	0	1	X	0	1	20.5
LNA Bypassed, Mixer Preamp Off, TX Buffer Off, /2 Off	0	1	1	0	0	X	0	1	15.5

FM/JCDMA- Low Current LNA Mode									
LNA On, Mixer Preamp On, TX Buffer Off, /2 Off	0	0	1	1	1	0	0	1	25.0
LNA On, Mixer Preamp Off, TX Buffer Off, /2 Off	0	0	1	1	0	0	0	1	20.0
LNA Bypassed, Mixer Preamp On, TX Buffer Off, /2 Off	0	0	1	0	1	X	0	1	20.5
LNA Bypassed, Mixer Preamp Off, TX Buffer Off, /2 Off	0	0	1	0	0	X	0	1	15.5

CDMA PCS - High IIP3 LNA Mode*									
LNA On, Mixer Preamp On TX Buffer Off, /2 Off*	1	1	1	1	1	1	0	1	27.5
LNA On, Mixer Preamp Off TX Buffer Off, /2 Off*	1	1	1	1	0	1	0	1	25.5
LNA Bypassed, Mixer Preamp On TX Buffer Off, /2 Off	1	1	1	0	1	X	0	1	21.0
LNA Bypassed, Mixer Preamp Off TX Buffer Off, /2 Off	1	1	1	0	0	X	0	1	16.0

GPS									
LNA On, Mixer On	1	0	1	X	X	0	0	X	24.0

NOTES:

All IDC current numbers include bias circuitry current of 1.5mA to 2.0mA (dependent on mode).

TX Buffer On: Add 2mA to total current.

/2 Select On: Add 2mA to total current.

"X" denotes setting does not impact current.

*For Paging mode set IPSET=0. Total current reduced 2mA.

Cascaded Performance (Typical Values for $V_{CC}=2.75V$)

NOTE: All total current numbers include bias circuitry current of 1.5mA to 2.0mA (dependent on mode).

Parameter	CELL CDMA			
	LNA ON	LNA OFF	LNA ON	LNA OFF
	LNA at Max IIP3, IPSET=1			
	Mixer Preamp On		Mixer Preamp Off	
Cascaded:				
Gain (dB)	25.0	7.5	15.0	-2.5
Noise Figure (dB)	2.1	13.0	4.5	19.5
Input IP3 (dBm)	-8.5	+8.9	+0.6	+17.6
LO to IF Isolation (dB)	30	30	30	30
IF1 to RF Isolation (dB)	40	40	40	40
IF2 to RF Isolation (dB)	40	40	40	40
LO to LNA IN Isolation (dB)	45	45	45	45
Total Current (mA)	*27.0	20.5	*22.0	15.5

NOTE: Assumes 3dB image filter insertion loss. The TX Buffer Enable is off. Div/2 function is off.

Numbers represent high linearity LNA bias setting IPSET=1.

*For Paging mode set IPSET=0. Total current reduced 2mA.

Parameter	FM/JCDMA			
	LNA ON	LNA OFF	LNA ON	LNA OFF
	Mixer Preamp On			
	Mixer Preamp On		Mixer Preamp Off	
Cascaded:				
Gain (dB)	24.5	7.5	14.5	-2.5
Noise Figure (dB)	2.1	13.0	4.8	19.5
Input IP3 (dBm)	-8.1	+8.9	+1.6	+18.4
LO to IF Isolation (dB)	30	30	30	30
IF1 to RF Isolation (dB)	40	40	40	40
IF2 to RF Isolation (dB)	40	40	40	40
LO to LNA IN Isolation (dB)	45	45	45	45
Total Current (mA)	25.0	20.5	20.0	15.5

NOTE: Assumes 3dB image filter insertion loss. The TX Buffer Enable is off. Div/2 function is off.

Numbers represent low current LNA bias setting IPSET=0.

Parameter	PCS CDMA			
	LNA ON	LNA OFF	LNA ON	LNA OFF
	LNA at Max IIP3, IPSET=1			
	Mixer Preamp ON		Mixer Preamp OFF	
Cascaded:				
Gain (dB)	26.5	7	17.0	-2.5
Noise Figure (dB)	2.2	14	5.0	22
Input IP3 (dBm)	-7.5	+11.8	+0.2	+19.0
LO to IF Isolation (dB)	40	40	40	40
IF1 to RF Isolation (dB)	40	40	40	40
IF2 to RF Isolation (dB)	40	40	40	40
LO to LNA IN Isolation (dB)	40	40	40	40
Total Current (mA)	*27.5	21.0	*22.5	16.0

NOTE: Assumes 3dB image filter insertion loss. The TX Buffer Enable is off. Div/2 function is off. Numbers represent high linearity LNA bias setting IPSET=1.
 *For Paging mode set IPSET=0. Total current reduced 2mA.

Cascaded Performance (Typical Values for V_{CC}=2.75V)

NOTE: All total current numbers include bias circuitry current of 1.5mA to 2.0mA (dependent on mode).

Parameter	GPS	
	High IIP3 LNA Mode, IPSET=1	IPSET=0
Cascaded:		
Gain (dB)	35.5	34.5
Noise Figure (dB)	1.6	1.6
Input IP3 (dBm)	-23.0	-22.0
Total Current (mA)	24	22

NOTE: Assumes 1.5dB image filter insertion loss. The TX Buffer Enable is off. /2 Select is off.

Cellular CDMA Gain Control

Gain	Bit 1	Bit 2	IMD Test
High Gain	1	1	IMD Test 1 and 2
Mid Gain	1	0	IMD Test 3 and 4
Low Gain	0	1	IMD Test 5 and 6 option 1
Ultra Low Gain	0	0	IMD test 5 and 6 option 2

Note: Contact RFMD for Application note on gain control PCBA layout and software recommendations.

Pin	Function	Type	Description	Interface Schematic
1	GPS+	AO	GPS IF output. Open collector.	
2	GPS-	AO	GPS IF output. Open collector.	See pin 1.
3	CDMA+	AO	CDMA IF output. Open collector.	
4	CDMA-	AO	CDMA IF output. Open collector.	See pin 3.
5	FM+	AO	FM IF output. Open collector. "Current combiner" IF interface to SAW filter recommended. (See "IF Output Matching Network" section.)	
6	FM-	AO	FM IF output. Open collector. "Current combiner" IF interface to SAW filter recommended. (See "IF Output Matching Network" section.)	See pin 5.
7	VCC2	P	VCC connection for internal LO amplifiers. Internal RF bypass capacitor. External bypass capacitor between 1nF and 47nF required.	
8	LO IN	AI	LO single-end input. Matched to 50Ω.	
9	LO OUT	AO	LO output. Internal DC block.	
10	/2 SELECT	DI	Logic input. Low enables /2 circuitry in cellular mode. The divider is disabled when BAND SEL (pin 27) is high, regardless of the state of pin 10. The divider can only be enabled when BAND SEL is low and pin10 is low. Pin 10 can be tied to a low state allowing BANDSEL (pin 27) to control the LO divider function, if using a single LO input source.	See pin 11.
11	TX BUFF ENABLE	DI	Logic input. High enables TX LO output buffer amplifiers.	
12	PCS RFA VCC	P	VCC connection for PCS mixer preamplifier.	
13	PCS MIX IN	AI	PCS mixer RF single-end input.	
14	CELL MIX IN	AI	Cellular mixer RF single-end input. Matched to 50Ω.	

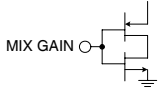
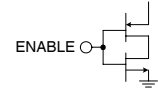
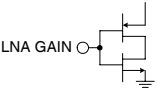
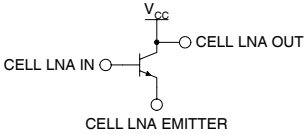
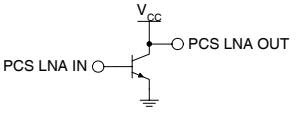
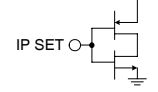
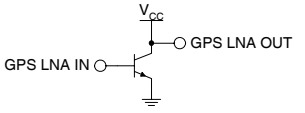
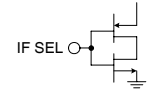
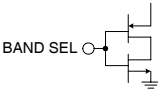
Pin	Function	Type	Description	Interface Schematic
15	MIX GAIN	DI	Logic input. Logic high turns on PCS or cellular mixer preamp and provides maximum gain. Logic low will bypass the PCS and cellular mixer preamp.	
16	ENABLE	DI	Logic input. Low level powers down the IC.	
17	LNA GAIN	DI	Logic input. High activates cellular or PCS LNAs. Low selects LNA bypass mode for both bands.	
18	CELL LNA OUT	AO	Cellular LNA output. Simple external L-C components required for matching and VCC supply.	See pin 20.
19	CELL LNA EMITTER	AO	Cellular LNA emitter. A small inductor connects this pin to ground. Cellular LNA gain can be adjusted by the inductance.	See pin 20.
20	CELL LNA IN	AI	Cellular LNA input.	
21	PCS LNA OUT	AO	PCS LNA output. Simple external L-C components required for matching and VCC supply.	
22	IP SET	DI	Logic input. High selects high IIP3 LNA “boost” modes for GPS, cellular and PCS CDMA paths. Low selects “normal” LNA IIP3 mode for GPS, cellular and PCS CDMA paths. Bias setting resistor at pin 31 allows for the adjustment of LNA IIP3 in boost mode.	
23	PCS LNA IN	AI	PCS LNA input. For best performance, simple external matching required.	See pin 21.
24	GPS LNA IN	AI	GPS LNA input. For best performance, simple external matching required.	
25	GPS LNA OUT	AO	GPS LNA output. Simple external L-C components required for matching and VCC supply.	See pin 24.
26	IF SEL	DI	Logic input. High selects CDMA IF outputs; low selects FM or GPS IF outputs.	
27	BAND SEL	DI	Logic input. High level selects PCS or GPS band; low level selects cellular band. The LO divider circuitry is disabled when BAND SEL is high, regardless of the state of pin 10 (/2 SELECT). When BAND SEL is low, pin 10 can be selected high or low. If using a single LO input, pin 10 can be tied to a low state allowing BAND SEL to control the LO divider function.	

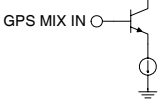
Pin	Function	Type	Description	Interface Schematic
28	GPS MIX IN	AI	GPS mixer RF single-end input.	
29	VCC1	P	DC supply for internal reference, logic control, cellular mixer preamp, and GPS mixer preamp (PCS mixer preamp has its' own DC supply, PCS_RFA_VCC). External bypass capacitor between 1nF and 47nF required.	
30	ISET1	AO	Resistor for internal voltage reference setting. Recommended value 5.1kΩ.	
31	ISET2	AO	Resistor to ground sets the LNA current in boost mode (all three LNAs). Higher resistance results in lower current.	
32	ISET3	AO	Resistor to ground sets preamp and mixer currents in all bands. Higher resistance results in lower currents.	
Pkg Base	GND	P	Ground connection. The backside of the package should be soldered to a top side ground pad which is connected to the ground plane with multiple vias.	

Legend:

- DI=Digital Input from Baseband Chip
- AI=Analog Input
- AO=Analog Output
- P=V_{CC} or GND

ISET Pins

ISET1 sets the internal reference voltage for the bias control circuits to all functional blocks. An external resistor of 5.1kΩ to ground is required. We do not recommend adjusting this resistor value. This resistor is pulled out to allow for a higher precision off chip value and not as a significant tuning adjustment.

ISET2 sets the DC current through the LNAs in all bands when IPSET is high. Higher resistance to ground results in lower current through the LNA. Increasing the LNA current will improve the IIP3 of the LNA and slightly increase gain in all modes. NF typically will get worse as you increase current. Increasing the LNA current in one mode, i.e. Cellular, will also increase the LNA current for the high IPSET state for PCS and the GPS LNAs as well.

ISET3 sets the DC current through the mixer and mixer preamplifier for all bands. Higher resistance to ground results in lower current. Lower current will improve mixer NF but will degrade IIP3. Mixer and the mixer preamp gain is not significantly changed with current.

Package Drawing

Application Schematic

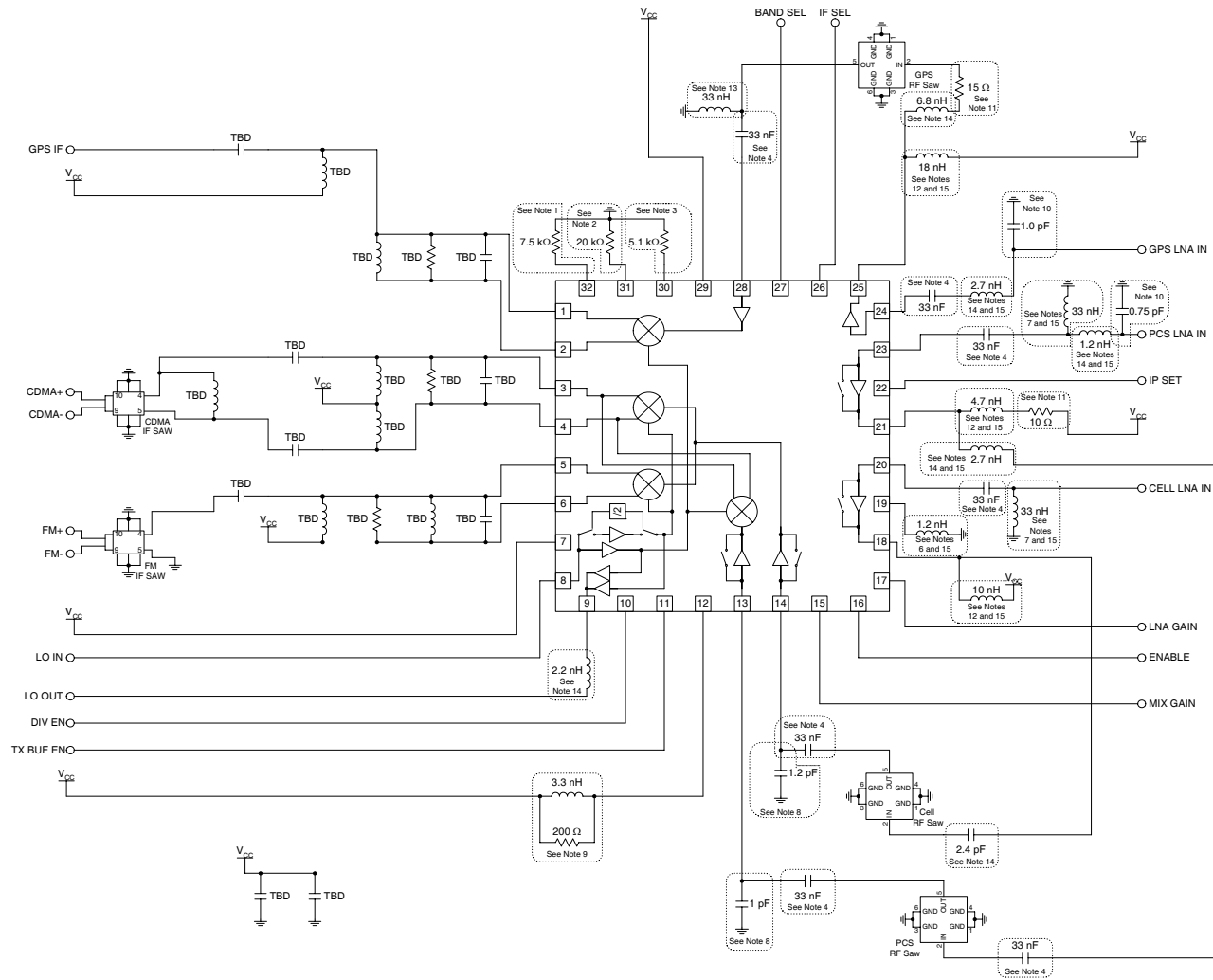

Note: If any functional blocks are not being used, the unused pins can be left with no connection.

Layout Note:

To minimize losses and radiation, the RF signal traces should be as short as possible. The IF+ and IF- outputs traces should be symmetrical. All bypass capacitors and matching capacitors must have a ground via very close to the capacitor. Each capacitor should have its own ground via. All traces should be 50 Ω transmission lines. Position inductors to reduce coupling (see note 15).

NOTES:

1. This resistor sets mixer preamp and mixer currents in all bands. Lowering the resistance results in higher currents.
2. This resistor sets LNA currents of all bands in boost mode. Increasing the resistor value results in lower currents.
3. Sets internal bias voltage. Recommend 5.1 kΩ.
4. DC blocking capacitor.
5. PCS LNA Input Matching. Optimize for NF.
6. Determines trade off between IIP3 and Gain.
7. Cell/PCS LNA Input Matching for optimum IIP3. Higher value inductor means lower gain and higher IIP3.
8. For cell and PCS mixer input matching.
9. PCS Interstage matching. As the value of the inductance is increased, the PCS mixer preamp gain will decrease and the IIP3 will increase and vice versa.
10. For optimum NF and input matching. As the value of the capacitance is increased, the NF will become worse.
11. To optimize performance over temperature and bias.
12. For output matching and a DC supply bias choke.
13. GPS mixer input matching for optimum IIP3.
14. Input or Output matching.
15. Coupling of coils on the input, output, and emitter (where applicable) of any LNA should be minimized to reduce the risk of oscillation. We recommend separating the inductors and/or positioning them 90° relative to each other.

NOTE: IF output matching component values are dependent on board layout, IF SAW filter and the IF frequency selected. Please contact RFMD application engineering for assistance with IF output matching.

Evaluation Board Schematic

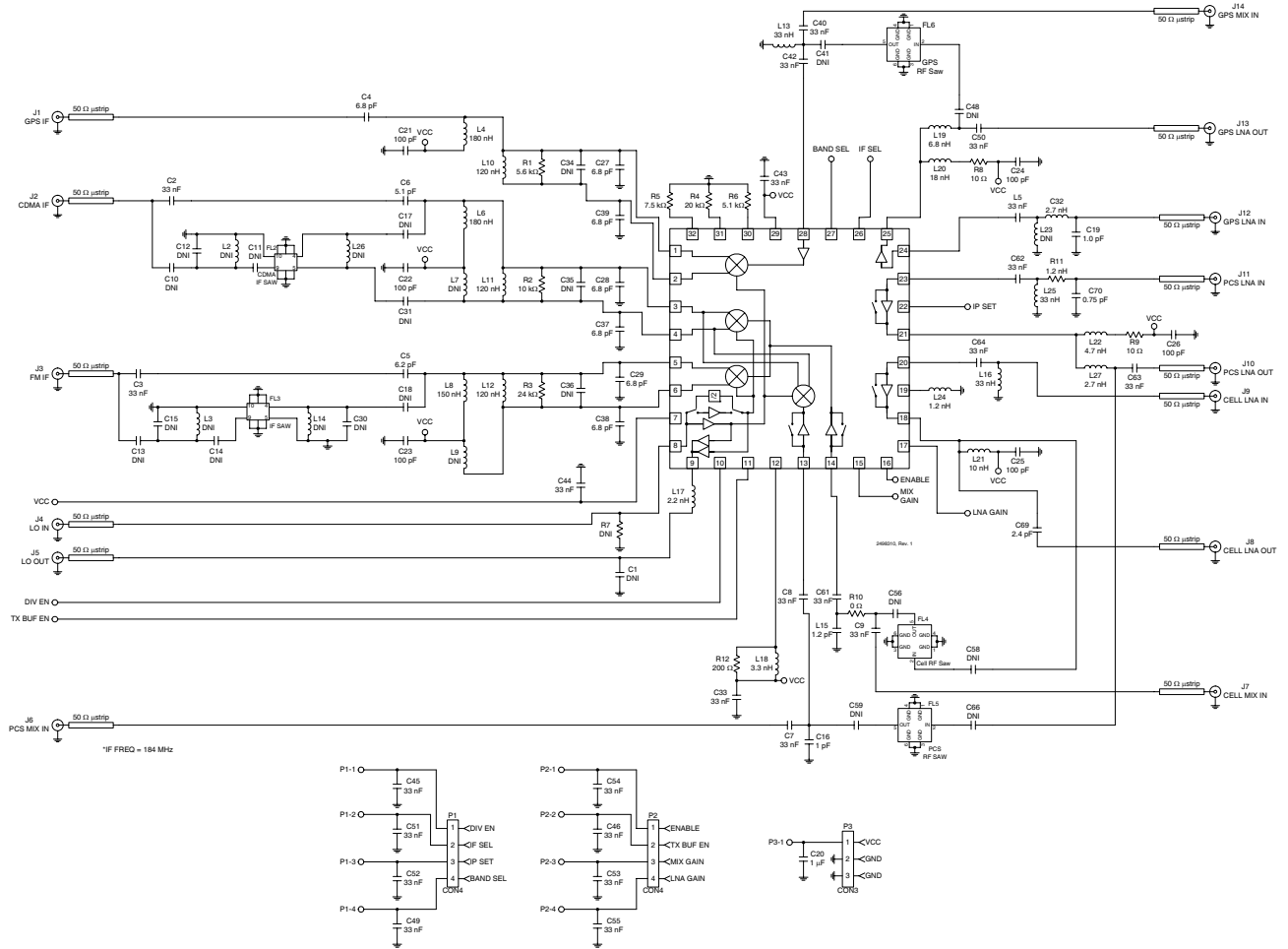

Evaluation Board Layout Board Size 3.0" x 3.0" Board Thickness 0.064", Board Material FR-4, Multi-Layer

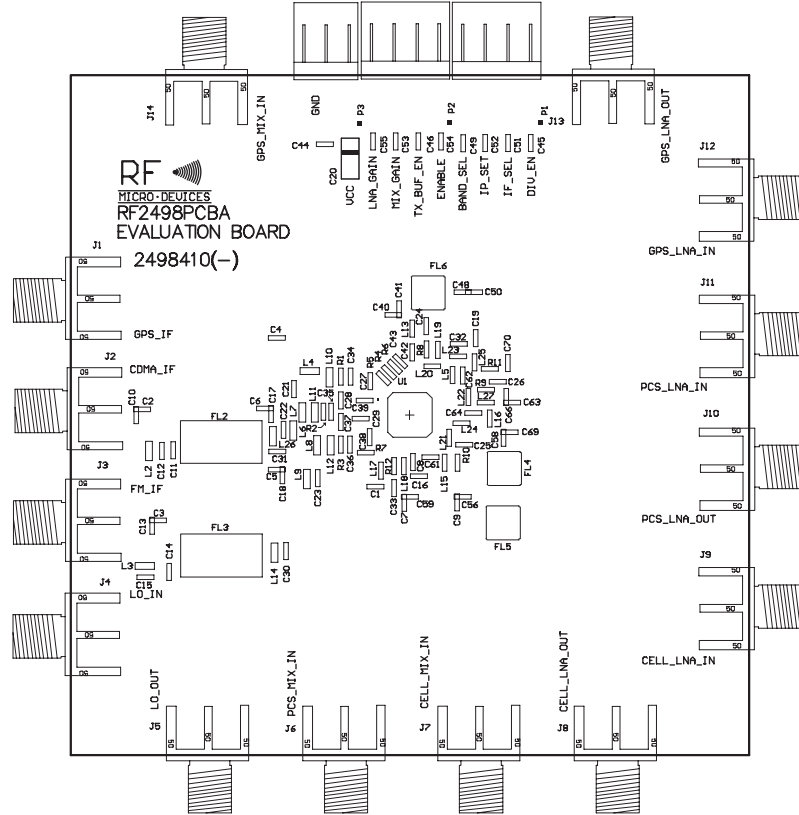

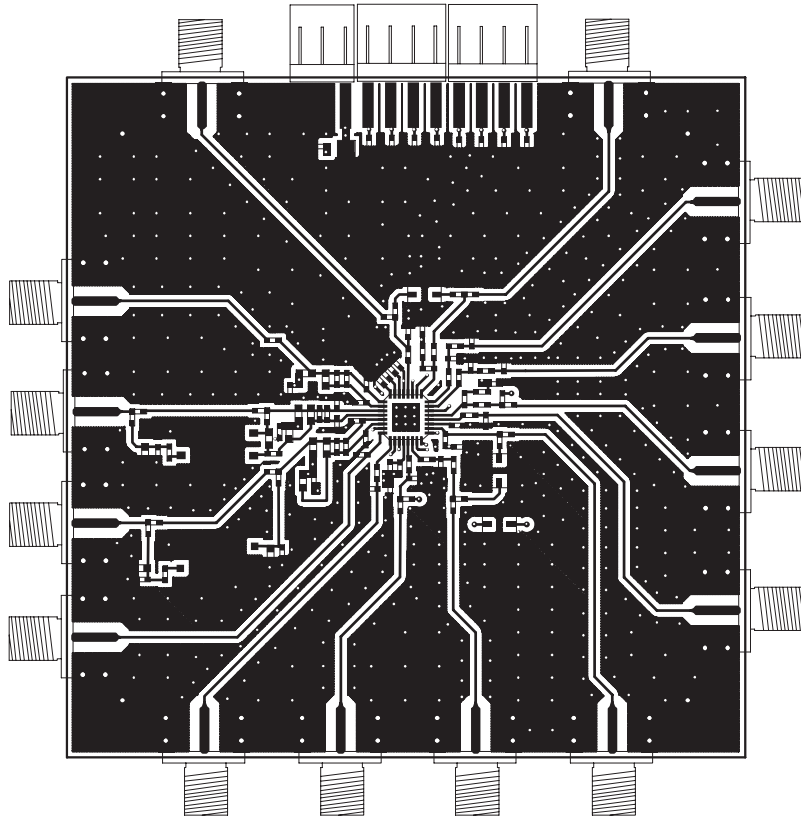

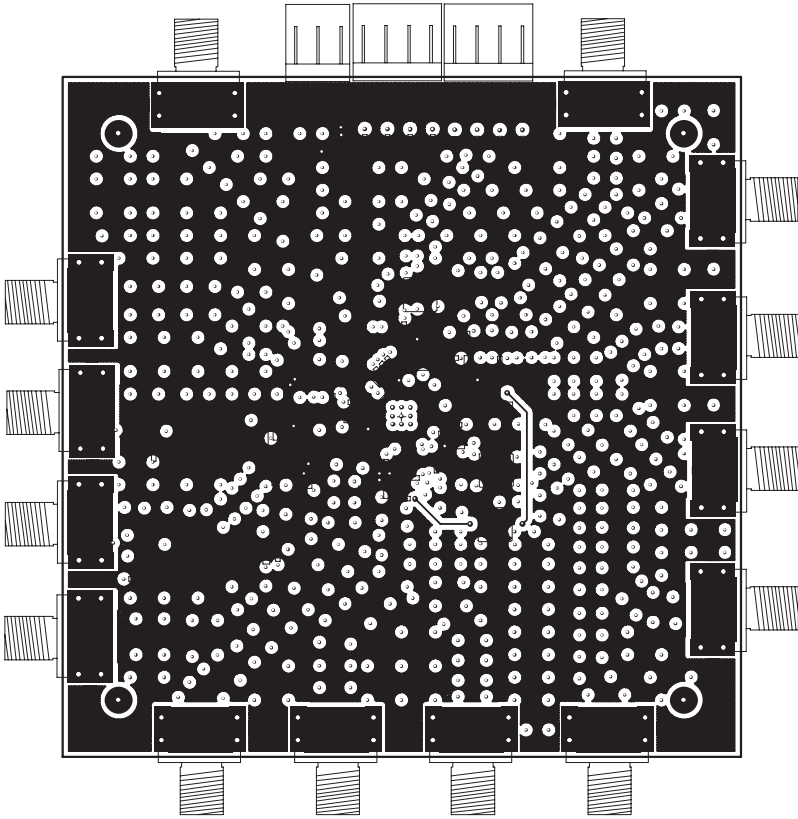

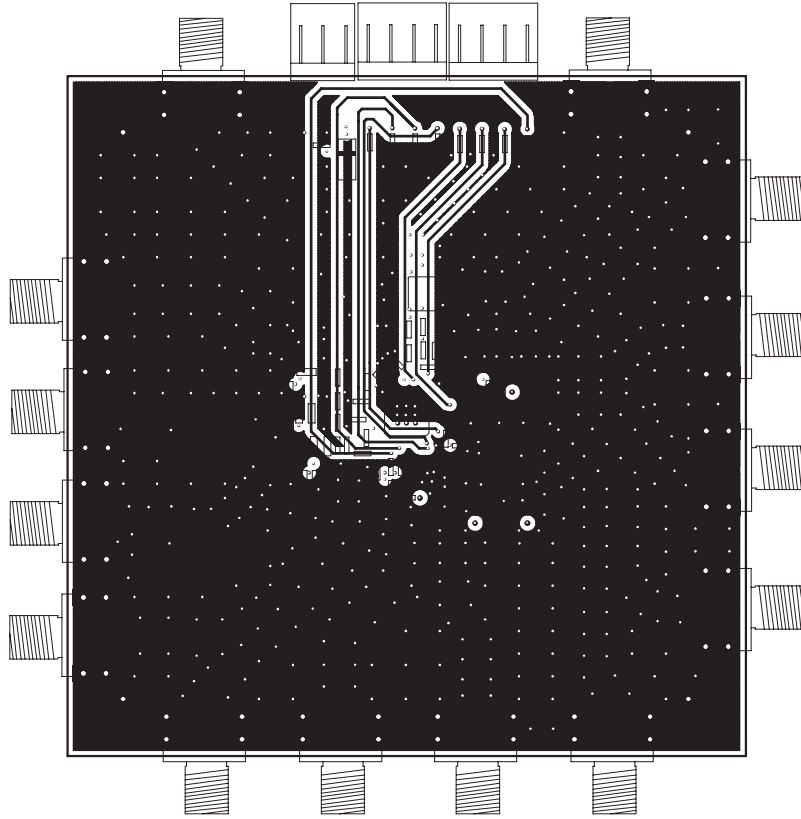

Cellular Band LO Output Power versus LO Input Power
(Freq=2128MHz, Divider=0(ON), V_{CC} 2.75V, Temp 25°C)

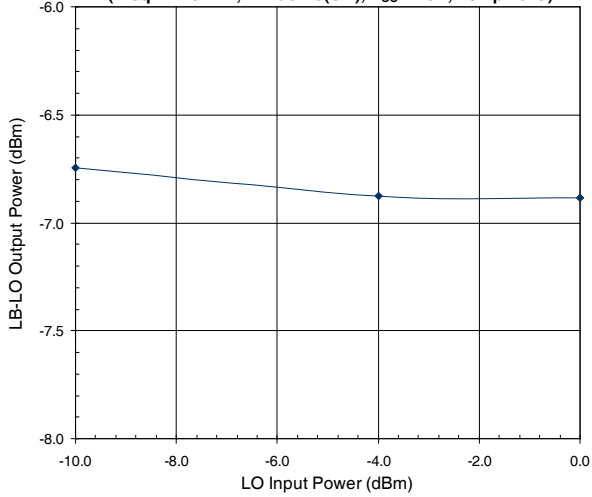

Cellular Band LO Output Power versus V_{CC}

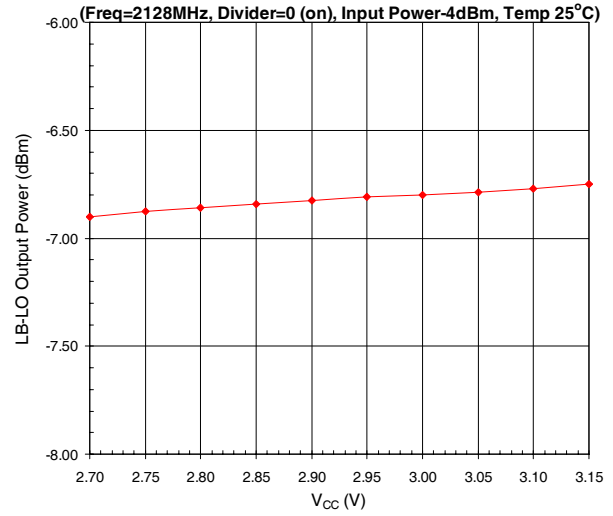

Cellular Band LO Output Power versus LO-Input Power
(Freq=1064MHz, Divider 1(off), V_{CC}=2.75V, Temp 25°C)

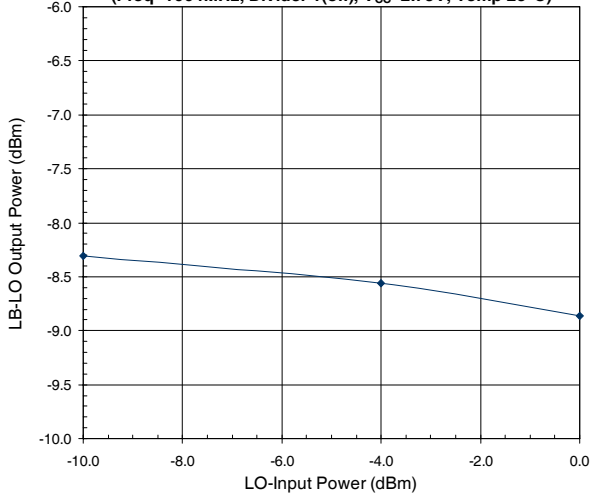

Cellular Band LO Output Power versus V_{CC}

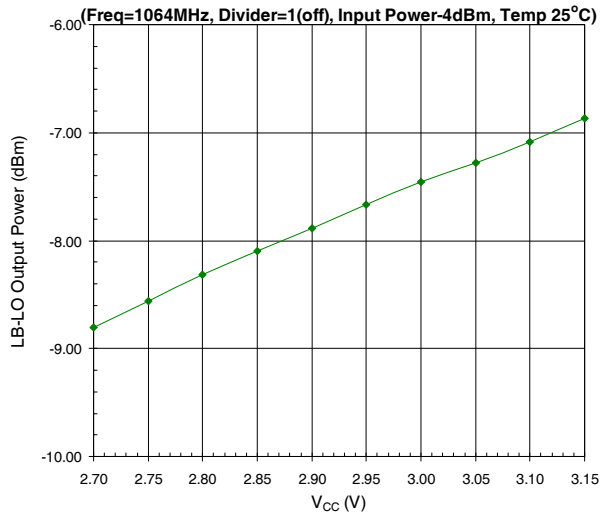

PCS Band LO Output Power versus LO-Input Power
(Freq=2144MHz, V_{CC} 2.75V, Temp 25°C)

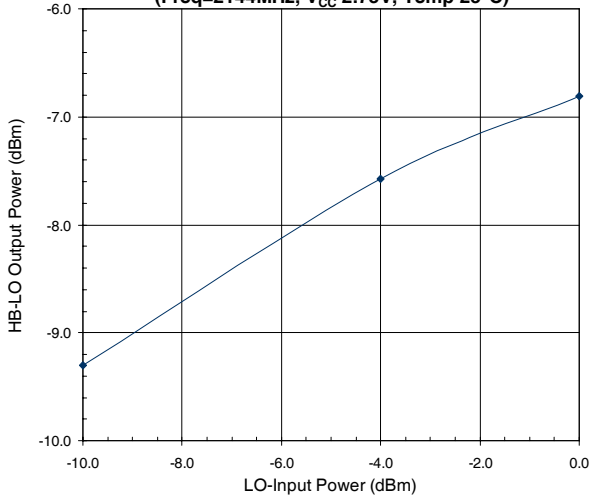

PCS Band LO Output Power versus V_{CC}
(Freq=2144MHz, Input Power -4dBm, Temp 25°C)

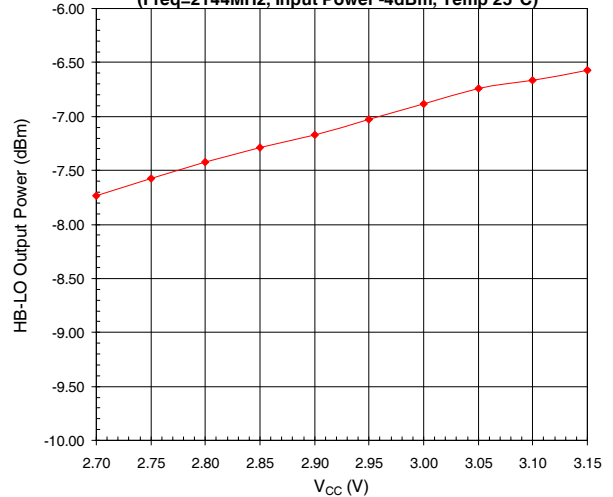

PCB Design Requirements

PCB Surface Finish

The PCB surface finish used for RFMD's qualification process is electroless nickel, immersion gold. Typical thickness is 3µinch to 8µinch gold over 180µinch nickel.

PCB Land Pattern Recommendation

PCB land patterns are based on IPC-SM-782 standards when possible. The pad pattern shown has been developed and tested for optimized assembly at RFMD; however, it may require some modifications to address company specific assembly processes. The PCB land pattern has been developed to accommodate lead and package tolerances.

PCB Metal Land Pattern

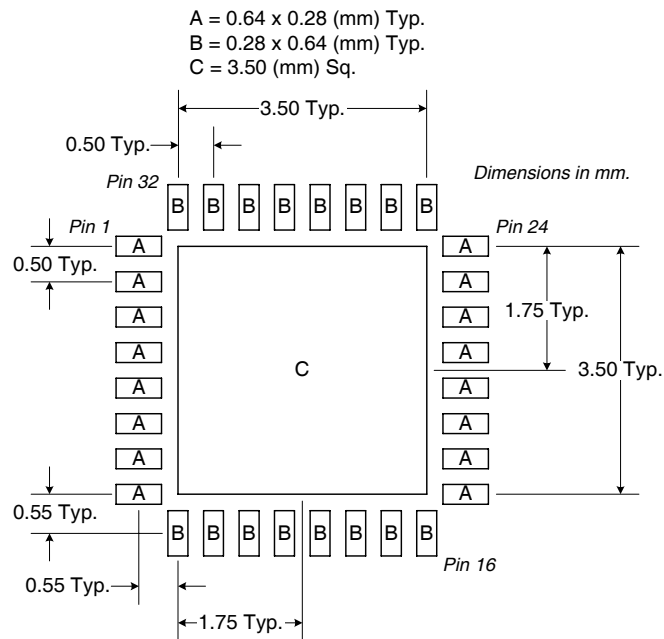

Figure 1. PCB Metal Land Pattern (Top View)

PCB Solder Mask Pattern

Liquid Photo-Imageable (LPI) solder mask is recommended. The solder mask footprint will match what is shown for the PCB metal land pattern with a 2mil to 3mil expansion to accommodate solder mask registration clearance around all pads. The center-grounding pad shall also have a solder mask clearance. Expansion of the pads to create solder mask clearance can be provided in the master data or requested from the PCB fabrication supplier.

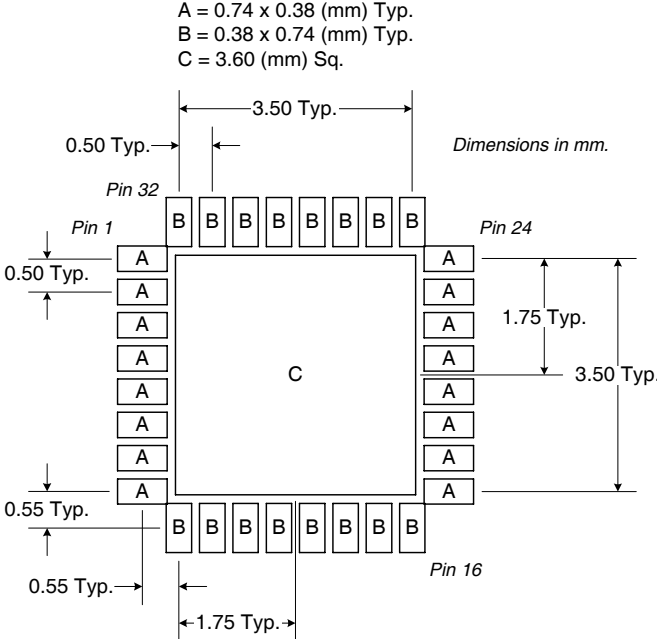

Figure 2. PCB Solder Mask Pattern (Top View)