

FEATURES

- Six-Sided Shielding
- Input to Output Isolation
- High Efficiency up to 88%
- Fixed Switching Frequency
- 15 Watts Maximum Output Power
- 4:1 Ultra Wide Input Voltage Range
- ISO9001 Certified Manufacturing Facilities
- Compliant to RoHS EU Directive 2002/95/EC
- Industry Standard Pin-Out DM Series Compatible
- Small Size and Low Profile: 1.0 x 1.0 x 0.39 Inches
- UL60950-1, EN60950-1, and IEC60950-1 Licensed
- CE Mark Meets 2006/95/EC, 93/68/EEC, and 2004/108/EC
- Options: Positive Logic Remote On/Off, Without Trim, Without On/Off pin

APPLICATIONS

- Measurement
- Wireless Network
- Telecom/Datacom
- Industry Control System
- Semiconductor Equipment



SPECIFICATIONS: JFCW Series

All specifications apply @ 25°C ambient unless otherwise noted

INPUT SPECIFICATIONS

Input Voltage Range	24V nominal input	9 - 36VDC
	48V nominal input	18 - 75VDC
Input Voltage Variation	dv/dt	5V/ms max (Complies with EST300 132 part 4.4)
Input Surge Voltage (100ms max)	24V input	50VDC
	48V input	100VDC
Reflected Ripple Current (nominal Vin and full load)		30mA _{p-p}
Start Up Time (nominal Vin and constant resistive load)		
Power Up		30ms max.
Remote ON/OFF		30ms max.
Start-Up Voltage	24V input	9VDC
	48V input	18VDC
Shutdown Voltage	24V input	8VDC
	48V input	16VDC
Remote ON/OFF (See Note 7)		
Positive Logic	DC-DC ON	Open or 3V < Vr < 12V
(option)	DC-DC OFF	Short or 0V < Vr < 1.2V
Negative Logic	DC-DC ON	Short or 0V < Vr < 1.2V
(standard)	DC-DC OFF	Open or 3V < Vr < 12V
Input Current of Remote Control Pin (nominal Vin)		-0.5mA ~ 1.0mA
Remote Off State Input Current (nominal Vin)		2.5mA

OUTPUT SPECIFICATIONS

Output Voltage		see table
Voltage Accuracy (full load and nominal Vin)		±1%
Voltage Adjustability (See Note 6)		±10%
Output Current		see table
Output Power		15 watts max.
Line Regulation (LL to HL at FL)	Single	±0.2%
	Dual	±0.5%
Load Regulation (no load to full load)	Single	±0.2%
	Dual	±0.5%
Minimum Load		0%
Ripple/Noise (20 MHz BW)		see table (measured with a 1µF M/C and a 10µF T/C)
Temperature Coefficient		±0.02% / °C max.
Transient Response Recovery Time (25% load step)		250us

PROTECTION SPECIFICATIONS

Over Voltage Protection	3.3V output	3.7V - 5.4V
	5V output	5.6V - 7.0V
	12V output	13.5V - 19.6V
	15V output	16.8V - 20.5V
Over Load Protection (% of FL at nominal input)		150% typ.
Short Circuit Protection		Hiccup, automatic recovery

GENERAL SPECIFICATIONS

Efficiency		see table
Switching Frequency		400KHz typ.
Isolation Voltage		
Input to Output		1600VDC min.
Input to Case		1000VDC min.
Output to Case		1000VDC min.
Isolation Resistance		10GΩ min.
Isolation Capacitance		1000pF max.

ENVIRONMENTAL SPECIFICATIONS

Operating Temperature		-40°C ~ +85°C (with derating)
Storage Temperature		-55°C ~ +125°C
Maximum Case Temperature		105°C
Relative Humidity		5% to 95% RH
Thermal Impedance (See Note 8)		
Natural Convection		18.2°C / Watt
Natural Convection with heat-sink		15.8°C / Watt
Thermal Shock		MIL-STD-810F
Vibration		10~55Hz, 2G, 3 min period, 30 min along X, Y, and Z
MTBF (See Note 1)		
BELLCORE TR-NWT-000332		1.330 x 10 ⁶ hours
MIL-HDBK-217F		5.630 x 10 ⁵ hours

PHYSICAL SPECIFICATIONS

Weight		15g
Dimensions		1.0 x 1.0 x 0.39 inches (25.4 x 25.4 x 9.9 mm)
Case Material		Nickel-coated copper
Base Material		Non-conductive black FR4
Potting Material		Epoxy (UL94-V0)
Shielding		six - sided

Due to advances in technology, specifications subject to change without notice

SAFETY & EMC

Approvals and Standards..... IEC60950-1, UL60950-1, EN60950-1	Radiated Immunity..... EN61000-4-3..... 10V/m	Perf. Criteria A
EMI (See Note 9) EN55022..... Class A	Fast Transient..... EN61000-4-4..... ±2KV	Perf. Criteria B
ESD..... EN61000-4-2..... Air Contact ± 8KV Perf. Criteria B	Surge (See Note 10)..... EN61000-4-5..... ±0.5KV	Perf. Criteria B
	Conducted Immunity..... EN61000-4-6..... 10 Vrms	Perf. Criteria A

OUTPUT VOLTAGE / CURRENT RATING CHART

Model Number	Input Range	Output Voltage	Output Current	Ripple & Noise ⁽⁴⁾	Input Current		Efficiency ⁽⁴⁾	Max Capacitor Load ⁽⁵⁾
					No Load ⁽³⁾	Full Load ⁽²⁾		
JFCW24S3.3-4000	24VDC (9 – 36 VDC)	3.3 VDC	4000mA	75mVp-p	50mA	688mA	86%	1000uF
JFCW24S5-3000		5 VDC	3000mA	75mVp-p	50mA	782mA	84%	1000uF
JFCW24S12-1300		12 VDC	1300mA	100mVp-p	20mA	803mA	86%	330uF
JFCW24S15-1000		15 VDC	1000mA	100mVp-p	20mA	772mA	85%	220uF
JFCW24D05-1500		± 5 VDC	±1500mA	100mVp	20mA	772mA	85%	500uF
JFCW24D12-625		± 12 VDC	± 625mA	100mVp	25mA	753mA	87%	150uF
JFCW24D15-500		± 15 VDC	± 500mA	100mVp	25mA	744mA	88%	100uF
JFCW48S3.3-4000	48VDC (18 – 75 VDC)	3.3 VDC	4000mA	75mVp-p	40mA	336mA	86%	1000uF
JFCW48S5-3000		5 VDC	3000mA	75mVp-p	40mA	382mA	86%	1000uF
JFCW48S12-1300		12 VDC	1300mA	100mVp-p	15mA	392mA	87%	330uF
JFCW48S15-1000		15 VDC	1000mA	100mVp-p	15mA	377mA	87%	220uF
JFCW48D05-1500		± 5 VDC	± 1500mA	100mVp	15mA	386mA	85%	500uF
JFCW48D12-625		± 12 VDC	± 625mA	100mVp	15mA	382mA	86%	150uF
JFCW48D15-500		± 15 VDC	± 500mA	100mVp	20mA	377mA	87%	100uF

*****See Product Standard Table for suffix options*****

NOTES

- BELLCORE TR-NWT-000332. Case 1: 50% Stress, Temperature at 40°C.
MIL-HDBK-217F Notice2 @Ta=25 °C, Full load (Ground fixed and controlled environment).
- Maximum value at nominal input voltage and full load.
- Typical value at nominal input voltage and no load.
- Typical value at nominal input voltage and full load.
- Test by minimum Vin and constant resistive load.
- Trimming allows the user to increase or decrease the output voltage set point of the module. This is accomplished by connecting an external resistor between the TRIM pin and either the +Vout pin or the -Vout pin.
- The ON/OFF control pin voltage is referenced to -Vin. (See the "Product Standard Table" below for suffix options).
- Heat Sink is optional. Consult factory for ordering details.
- The JFCW Series can meet EN55022 Class A with external capacitors connected in parallel to the input pins.
Recommended: 24Vin: 6.8uF/50V
48Vin: 2.2uF/100 * 2 pcs
- An external filter capacitor is required if the module has to meet EN61000-4-5. The filter capacitor Wall Industries suggests: Nippon chemi-con KY Series, 220uF/100V, ESR 48mΩ.

DERATING CURVES & EFFICIENCY GRAPHS

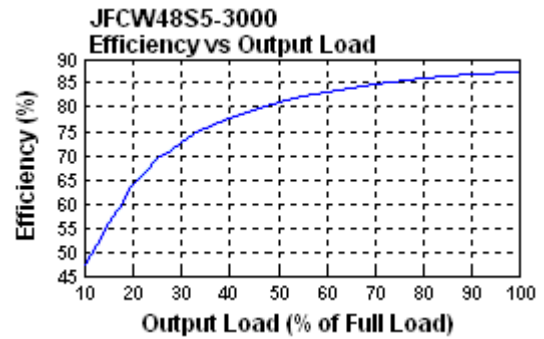
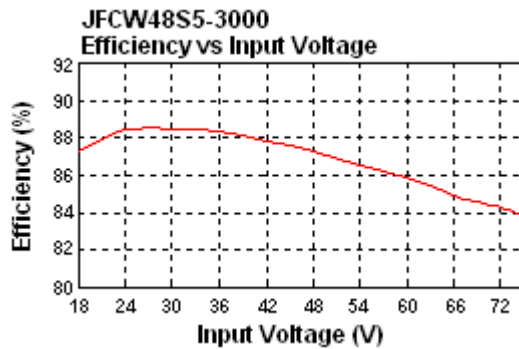
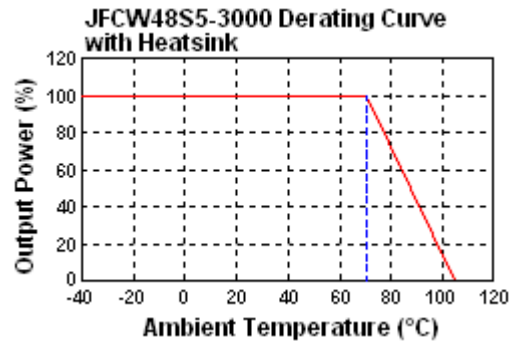
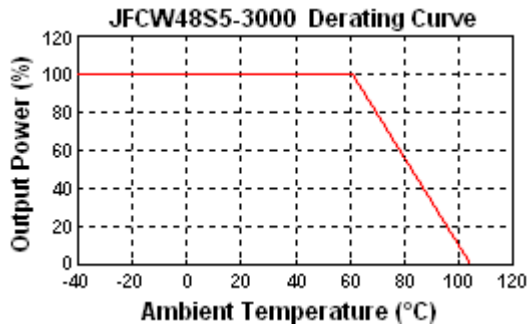

MECHANICAL DRAWING

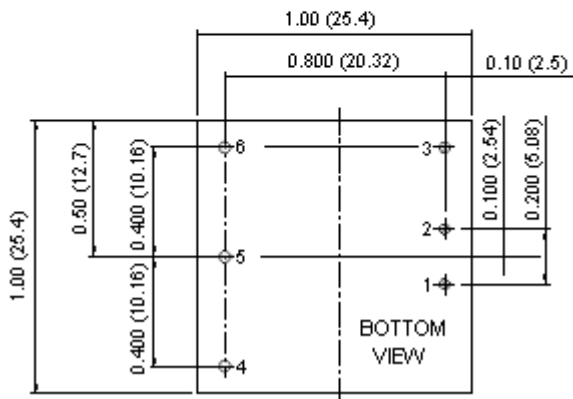
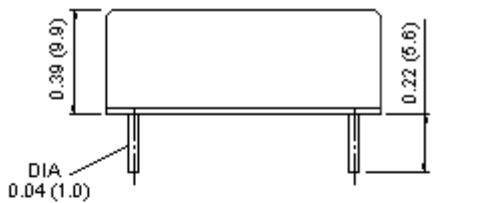

PIN CONNECTION		
PIN	SINGLE	DUAL
1	+ INPUT	+ INPUT
2	- INPUT	- INPUT
3	ON/OFF	ON/OFF
4	+VOUT	+VOUT
5	TRIM	COMMON
6	-VOUT	-VOUT

PRODUCT STANDARD TABLE	
Option	Suffix
Negative Remote ON/OFF	R
Positive Remote ON/OFF	Blank
Without ON/OFF pin	D
Without ON/OFF & TRIM pin	G
Negative Remote ON/OFF without TRIM pin	RF
Positive Remote ON/OFF without TRIM pin	F

NOTES:

- All dimensions in inches (mm)
Tolerance: X.XX±0.02 (X.X±0.5)
X.XXX±0.01 (X.XX±0.25)
- Pin pitch tolerance: ±0.01 (0.25)

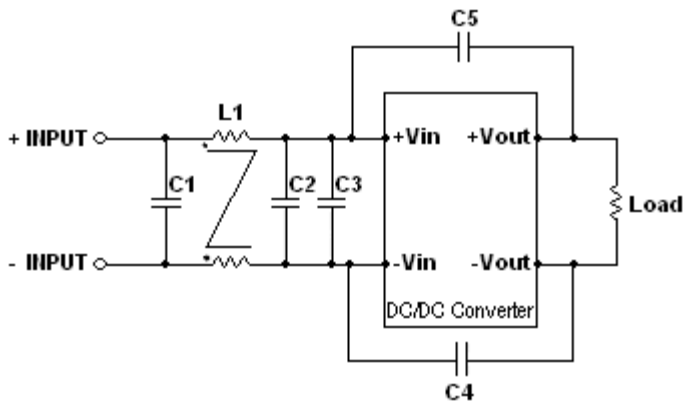

Recommended Filter for EN55022 Class B Compliance

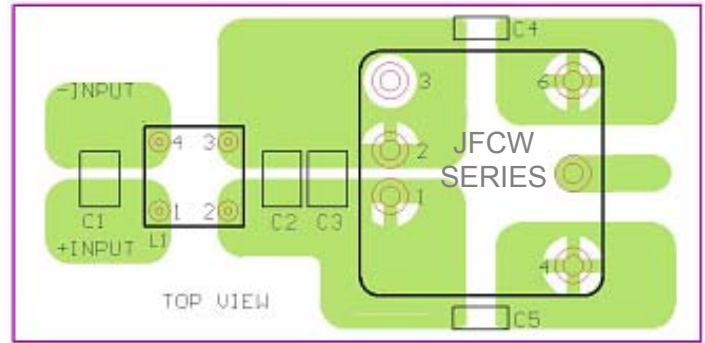

Recommended EN55022 Class B Filter Circuit

The components used in Figure 1, together with the manufacturers' part numbers for these components, are as follows:

	C1	C2	C3	C4 & C5	L1
JFCW24Sxx-xxxx	6.8uF/50V	6.8uF/50V	N/A	470pF/2KV	325uH Common Choke
JFCW48Sxx-xxxx	2.2uF/100V	2.2uF/100V	2.2uF/100V	470pF/2KV	620uH Common Choke

EXTERNAL OUTPUT TRIMMING

Output can be externally trimmed by using the method shown below.

