

**RoHS**  **233 Series, 5 x 20 mm, Medium-Acting Fuse**

### Description

5x20mm medium-acting glass body fuse designed to UL specification.





### Features

- Designed to UL/CSA/ ANCE 248 Standard
- Available in cartridge and axial lead format
- RoHS compliant and lead-free

### Applications

Used as supplementary protection in appliance or utilization equipment to provide individual protection for components or internal circuits.





### Agency Approvals

| Agency  | Agency File Number  | Ampere Range        |
|---|---|---------------------|
|    | Cartridge Certificates:<br>NBK280602-E10480 C<br>NBK290502-E10480 I | 1A – 5A<br>6A – 10A |
|   | Leaded Certificates:<br>NBK280602-E10480 D<br>NBK290502-E10480 J    | 1A – 5A<br>6A – 10A |
|   | Certificates:<br>SU05001 – 2010                                     | 1A – 6.5A           |
|  | Listed File:<br>E10480<br>Guide:<br>JDYX                            | 1A – 10A            |
|   | File:<br>029862<br>Acc. Class:<br>LR1422-01                         |                     |
|  |   |                     |
|  |   |                     |

### Electrical Characteristics for Series

| % of Ampere Rating | Ampere Rating | Opening Time                   |
|--------------------|---------------|--------------------------------|
| 100%               | 1A – 3.5A     | 4 hours, Minimum               |
|                    | 4A – 7A       | 1 hour, Minimum                |
|                    | 8A – 10A      | 1 hour, Minimum                |
| 135%               | 1A – 3.5A     | 15 sec., Min; 1500 sec., Max.  |
|                    | 4A – 7A       | 15 sec., Min; 1500 sec., Max.  |
|                    | 8A – 10A      | 3 sec., Min; 3600 sec., Max.   |
| 200%               | 1A – 3.5A     | .60 sec., Min; 3 sec., Max.    |
|                    | 4A – 7A       | .60 sec., Min; 3 sec., Max.    |
|                    | 8A – 10A      | 0.4 sec., Min; 2.25 sec., Max. |

### Electrical Characteristic Specifications by Item

| Amp Code | Amp Rating (A) | Voltage Rating (V) | Interrupting Rating | Nominal Cold Resistance (Ohms) | Nominal Melting I <sup>2</sup> t (A <sup>2</sup> sec) | Agency Approvals  |   |   |   |   |
|----------|----------------|--------------------|---------------------|--------------------------------|---|---|---|---|---|---|
|          |                |                    |                     |                                |   |  |  |  |  |  |
| 001.     | 1              | 125                | 10,000A @ 125 VAC   | 0.1750                         | 1.97500   | x   | x   | x   | x   | x   |
| 1.25     | 1.25           | 125                |                     | 0.1263                         | 3.39000   | x   | x   | x   | x   | x   |
| 01.6     | 1.6            | 125                |                     | 0.0880                         | 6.14000   | x   | x   | x   | x   | x   |
| 002.     | 2              | 125                |                     | 0.0684                         | 9.97000   | x   | x   | x   | x   | x   |
| 02.5     | 2.5            | 125                |                     | 0.0521                         | 17.04500  | x   | x   | x   | x   | x   |
| 003.     | 3              | 125                |                     | 0.0431                         | 26.24000  | x   | x   | x   | x   | x   |
| 3.15     | 3.15           | 125                |                     | 0.0380                         | 29.79500  | x   | x   | x   | x   | x   |
| 03.5     | 3.5            | 125                |                     | 0.0322                         | 36.27500  | x   | x   | x   | x   | x   |
| 004.     | 4              | 125                |                     | 0.0293                         | 51.61000  | x   | x   | x   | x   | x   |
| 005.     | 5              | 125                |                     | 0.0217                         | 89.97500  | x   | x   | x   | x   | x   |
| 006.     | 6              | 125                |                     | 0.0179                         | 131.45500   | x   | x   | x   | x   | x   |
| 06.3     | 6.3            | 125                |                     | 0.0166                         | 151.90500   | x   | x   | x   | x   | x   |
| 007.     | 7              | 125                |                     | 0.0137                         | 157.31000   | x   | x   |   | x   |   |
| 008.     | 8              | 125                |                     | 0.0084                         | 169.43500   | x   | x   | x   | x   |   |
| 010.     | 10             | 125                |                     | 0.0066                         | 274.11500   | x   | x   | x   | x   |   |

## Temperature Derating Curve

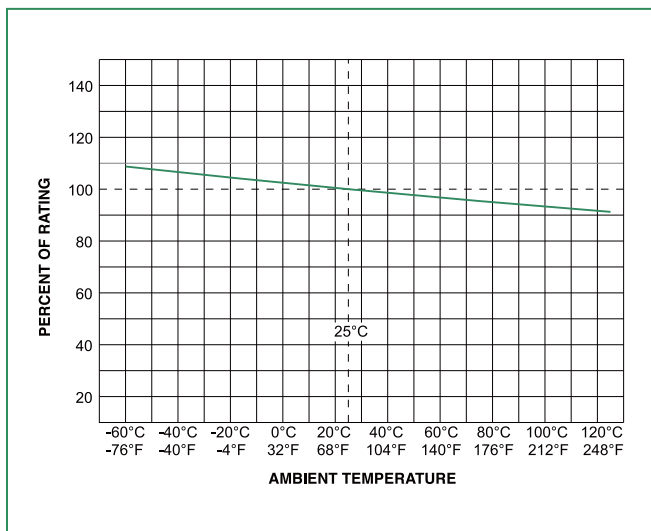

## Average Time Current Curves

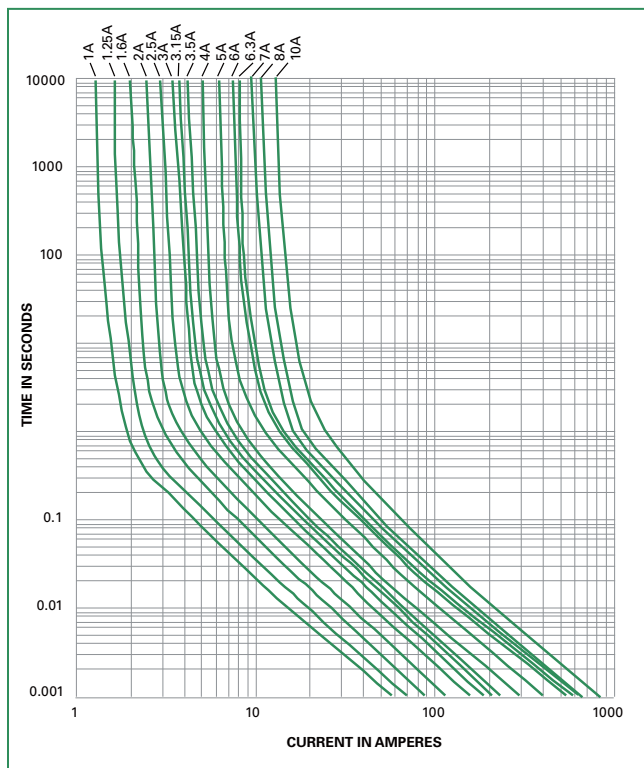

## Soldering Parameters - Wave Soldering

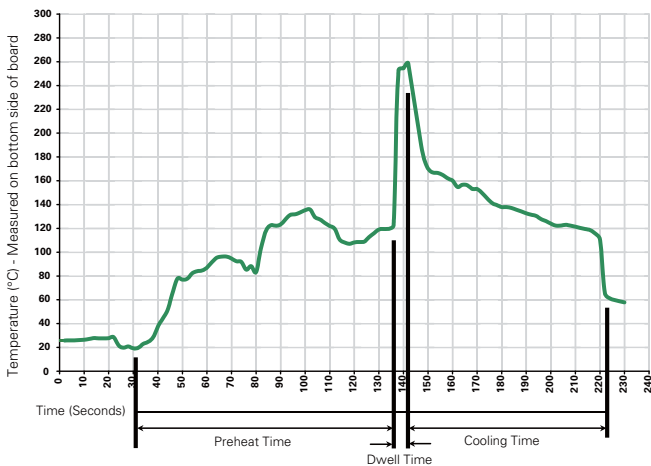

### Recommended Process Parameters:

| Wave Parameter  | Lead-Free Recommendation                    |
|---|---|
| <b>Preheat:</b><br>(Depends on Flux Activation Temperature) |   |
| Temperature Minimum:  | 100° C<br>(Typical Industry Recommendation) |
| Temperature Maximum:  | 150° C                                      |
| Preheat Time:   | 60-180 seconds                              |
| <b>Solder Pot Temperature:</b>                              | 260° C Maximum                              |
| <b>Solder Dwell Time:</b>                                   | 2-5 seconds                                 |

### Recommended Hand-Solder Parameters:

Solder Iron Temperature: 350° C +/- 5°C  
Heating Time: 5 seconds max.

**Note: These devices are not recommended for IR or Convection Reflow process.**

### Product Characteristics

|                          |   |
|--------------------------|---|
| <b>Materials</b>         | Body: Glass<br>Cap: Nickel-plated brass<br>Leads: Tin-plated Copper                         |
| <b>Terminal Strength</b> | MIL-STD-202G, Method 211A, Test Condition A   |
| <b>Solderability</b>     | Reference IEC 60127 Second Edition 2003-01 Annex A  |
| <b>Product Marking</b>   | Cap 1: Brand logo, current and voltage rating<br>Cap 2: Series and agency approval markings |
| <b>Packaging</b>         | Available in Bulk (M=1000 pcs/pkg) or on Tape/Reel (MRET1=1000 pcs/reel)                    |

|                              |   |
|------------------------------|---|
| <b>Operating Temperature</b> | -55°C to +125°C   |
| <b>Thermal Shock</b>         | MIL-STD-202G, Method 107G, Test Condition B: (5 cycles -65°C to +125°C)                           |
| <b>Vibration</b>             | MIL-STD-202G, Method 201A   |
| <b>Humidity</b>              | MIL-STD-202G, Method 103B, Test Condition A. high RH (95%) and elevated temp (40°C) for 240 hours |
| <b>Salt Spray</b>            | MIL-STD-202G, Method 101D, Test Condition B   |

### Dimensions

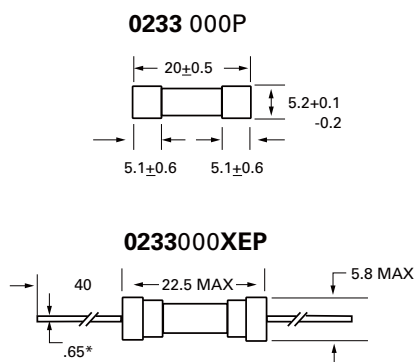

All dimensions in mm

Notes:

\* Ratings above 6.3A have 0.8 mm dia lead

### Part Numbering System

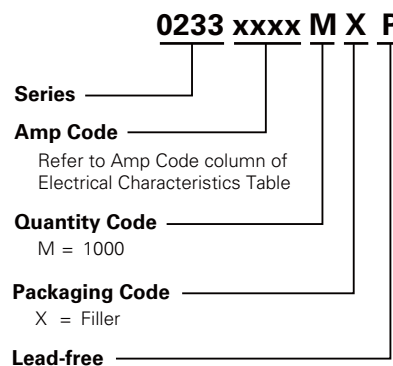

### Packaging

| Packaging Option  | Packaging Specification | Quantity | Quantity & Packaging Code | Taping Width     |
|-------------------|-------------------------|----------|---------------------------|------------------|
| <b>233 Series</b> |                         |          |                           |                  |
| Bulk              | N/A                     | 1000     | MX                        | N/A              |
| Bulk              | N/A                     | 1000     | MXE                       | N/A              |
| Reel and Tape     | EIA 296-E               | 1000     | MRET1                     | T1=52mm (2.062") |
| Bulk              | N/A                     | 1000     | MXB                       | N/A              |

