

Data sheet | Item number: 2206-1204

2-conductor through terminal block; with push-button; 6 mm²; with test port; suitable for Ex i applications; side and center marking; for DIN-rail 35 x 15 and 35 x 7.5; Push-in CAGE CLAMP®; 6,00 mm²; blue

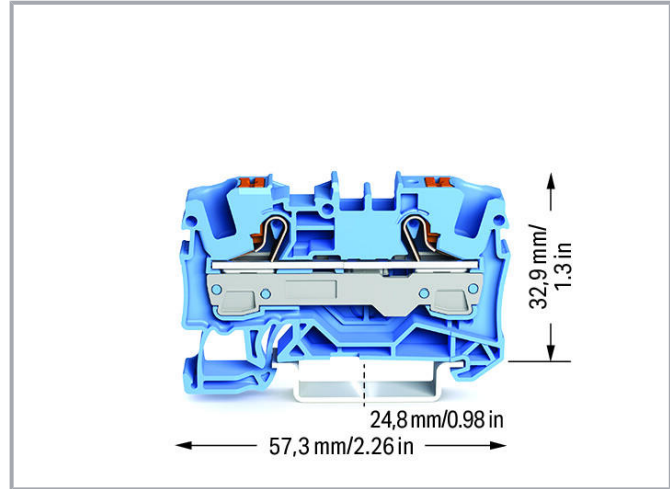

www.wago.com/2206-1204

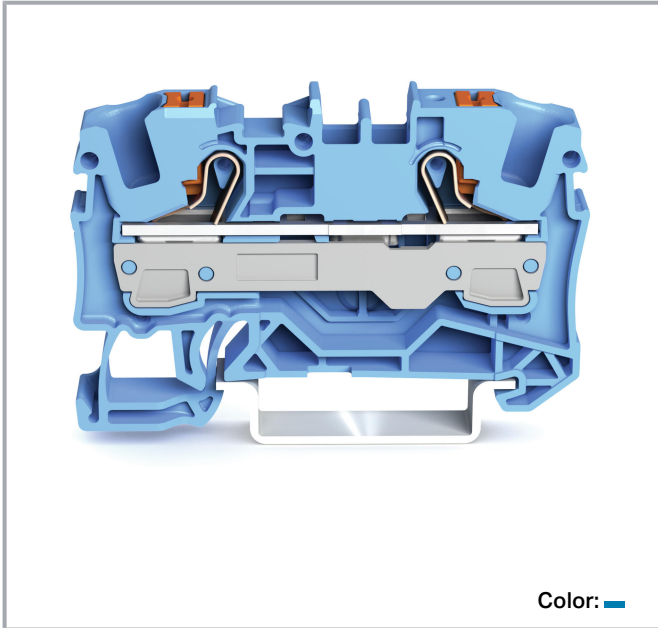

Color: 

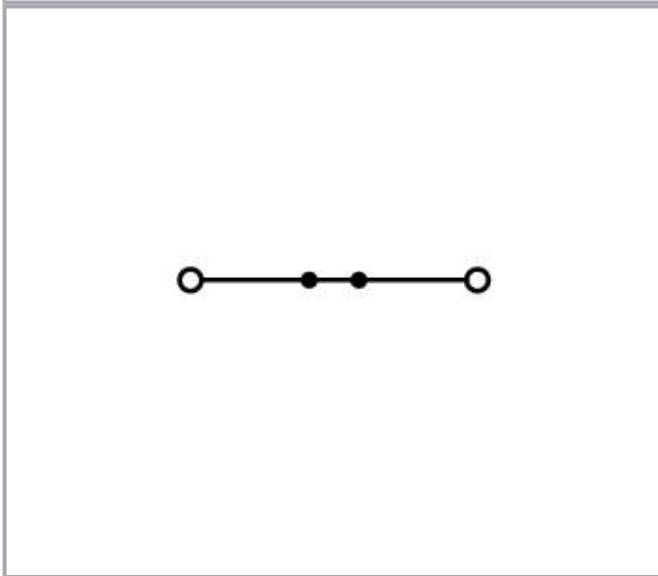

Data

Electrical data

Subject to changes. Please also observe the further product documentation!

WAGO GmbH & Co. KG
Hansastr. 27
32423 Minden
Phone: +49571 887-0 | Fax: +49571 887-169
Email: info.de@wago.com | Web: www.wago.com

Do you have any questions about our products?
We are always happy to take your call at +49 (571) 887-44222.



Ratings per IEC/EN

Ratings per	IEC/EN 60947-7-1
Nominal voltage (III/3)	800 V
Rated surge voltage (III/3)	8 kV
Rated current	41 A
Rated current 2	57 A
Legend (ratings)	(III / 3) $\hat{=}$ Overvoltage category III / Pollution degree 3

Ratings per UL

Approvals per	UL 1059
Rated voltage UL (Use Group B)	600 V
Rated current UL (Use Group B)	50 A
Rated voltage UL (Use Group C)	600 V
Rated current UL (Use Group C)	50 A

Ratings per CSA

Approvals per	C22.2 No 158
Rated voltage CSA (Use Group B)	600 V
Rated current CSA (Use Group B)	50 A
Rated voltage CSA (Use Group C)	600 V
Rated current CSA (Use Group C)	50 A

Ex information

Ratings per	ATEX: PTB 18 ATEX 1007 U / IECEx: PTB 18.0014U
Rated voltage EN (Ex e II)	550 V
Rated current (Ex e II)	41 A
Rated current (Ex e II) with jumper	33 A

Connection data

Total number of connection points	2
Total number of potentials	1
Number of levels	1
Number of jumper slots	2

Connection 1

Connection technology

Subject to changes. Please also observe the further product documentation!



	Push-in CAGE CLAMP®
Actuation type	Push-in Push-button Operating tool
Connectable conductor materials	Copper
Nominal cross-section	6 mm ²
Solid conductor	0.5 ... 10 mm ² / 20 ... 8 AWG
Solid conductor; push-in termination	1 ... 10 mm ² / 14 ... 8 AWG
Fine-stranded conductor	0.5 ... 10 mm ² / 20 ... 8 AWG
Fine-stranded conductor; with insulated ferrule	0.5 ... 6 mm ² / 20 ... 10 AWG
Fine-stranded conductor; with ferrule; push-in termination	2.5 ... 6 mm ² / 16 ... 10 AWG
Note (conductor cross-section)	Depending on the conductor characteristic, a conductor with a smaller cross-section can also be inserted via push-in termination.
Strip length	13 ... 15 mm / 0.51 ... 0.59 inch
Wiring direction	Front-entry wiring

Physical data

Width	7.5 mm / 0.295 inch
Height	57.3 mm / 2.256 inch
Depth from upper edge of DIN-rail	32.9 mm / 1.295 inch

Mechanical data

Design	horizontal type
Mounting type	DIN-35 rail
Marking level	Center/side marking

Material data

Color	blue
Insulation material	Polyamide (PA66)
Flammability class per UL94	V0
Fire load	0.188 MJ
Weight	10 g

Commercial data

PU (SPU)	50 Stück
Packaging type	box
Country of origin	DE

Subject to changes. Please also observe the further product documentation!

WAGO GmbH & Co. KG
 Hansastr. 27
 32423 Minden
 Phone: +49571 887-0 | Fax: +49571 887-169
 Email: info.de@wago.com | Web: www.wago.com

Do you have any questions about our products?
 We are always happy to take your call at +49 (571) 887-44222.



GTIN	4055143712040
Customs tariff number	85369010000

Approvals / Certificates

Ex-Approvals



Logo	Approval	Additional Approval Text	Certificate name
	AEx Underwriters Laboratories Inc.	UL 60079	E185892 (AEx eb IIC resp. Ex eb IIC)
	ATEX Physikalisch Technische Bundesanstalt	IEC 60079-0	PTB 18 ATEX 1007 U (II 2 Ex eb IIC Gb bzw. I M 2 Ex eb I Mb)
	EAC Brjansker Zertifizierungsstelle	TP TC 012/2011	RU C-DE. AM02.B. 00127/19 (Ex e IIC Gb U)
	IECEX Physikalisch Technische Bundesanstalt	IEC 60079	IECEX PTB 18.0014U (Ex eb IIC Gb and Ex eb I Mb)

Country specific Approvals

Logo	Approval	Additional Approval Text	Certificate name
	CCA DEKRA Certification B.V.	EN 60947	NTR NL 7880
	CSA DEKRA Certification B.V.	C22.2	70175034
	KEMA/KEUR DEKRA Certification B.V.	EN 60947	71- 119270

Subject to changes. Please also observe the further product documentation!

Ship Approvals



Logo	Approval	Additional Approval Text	Certificate name
	ABS American Bureau of Shipping	-	19- HG1866350- PDA
	DNV GL Det Norske Veritas, Germanischer Lloyd	-	TAE00003JT
	LR Lloyds Register	-	19/20050

UL-Approvals

Logo	Approval	Additional Approval Text	Certificate name
	UL Underwriters Laboratories Inc.	C22.2 No. 158	478863229



Required accessories

End plate











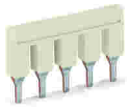

End plate		
	Item no.: 2006-1292 End and intermediate plate; 1 mm thick; orange	www.wago.com/2006-1292
	Item no.: 2006-1291 End and intermediate plate; 1 mm thick; gray	www.wago.com/2006-1291

Optional accessories

Ferrule

Ferrule		
	Item no.: 216-208 Ferrule; Sleeve for 6 mm ² / AWG 10; insulated; electro-tin plated; electrolytic copper; gastight crimped; acc. to DIN 46228, Part 4/09.90; yellow	www.wago.com/216-208
	Item no.: 216-263 Ferrule; Sleeve for 1 mm ² / AWG 18; insulated; electro-tin plated; electrolytic copper; gastight crimped; acc. to DIN 46228, Part 4/09.90; red	www.wago.com/216-263
	Item no.: 216-266	

Subject to changes. Please also observe the further product documentation!

	Ferrule; Sleeve for 2.5 mm ² / AWG 14; insulated; electro-tin plated; electrolytic copper; gastight crimped; acc. to DIN 46228, Part 4/09.90; blue	www.wago.com/216-266
	Item no.: 216-264 Ferrule; Sleeve for 1.5 mm ² / AWG 16; insulated; electro-tin plated; electrolytic copper; gastight crimped; acc. to DIN 46228, Part 4/09.90; black	www.wago.com/216-264
	Item no.: 216-262 Ferrule; Sleeve for 0.75 mm ² / 18 AWG; insulated; electro-tin plated; electrolytic copper; gastight crimped; acc. to DIN 46228, Part 4/09.90; gray	www.wago.com/216-262
	Item no.: 216-267 Ferrule; Sleeve for 4 mm ² / AWG 12; insulated; electro-tin plated; electrolytic copper; gastight crimped; acc. to DIN 46228, Part 4/09.90; gray	www.wago.com/216-267
Jumpers		
Jumper		
	Item no.: 2006-402 Jumper; 2-way; insulated; light gray	www.wago.com/2006-402
	Item no.: 2006-405 Jumper; 5-way; insulated; light gray	www.wago.com/2006-405
	Item no.: 2006-433 Jumper; from 1 to 3; insulated; light gray	www.wago.com/2006-433
	Item no.: 2006-403 Jumper; 3-way; insulated; light gray	www.wago.com/2006-403
	Item no.: 2006-405/011-000 Star point jumper; 3-way; insulated; light gray	www.wago.com/2006-405/011-000
	Item no.: 2006-404 Jumper; 4-way; insulated; light gray	www.wago.com/2006-404
	Item no.: 2006-434 Jumper; from 1 to 4; insulated; light gray	www.wago.com/2006-434
	Item no.: 2006-435 Jumper; from 1 to 5; insulated; light gray	www.wago.com/2006-435
	Item no.: 2006-499 Step-down jumper; from 2006/2004 to 2004/2002/2001 series; insulated; light gray	www.wago.com/2006-499
	Item no.: 2016-499 Step-down jumper; from 2016/2010 to 2010/2006/2004/2002 series; insulated; light gray	www.wago.com/2016-499
Testing and measuring		
Testing accessories		
	Item no.: 2009-174 Test plug adapter; for 4 mm Ø test plugs; for testing TOPJOB®S rail-mounted terminal blocks; gray	www.wago.com/2009-174

Subject to changes. Please also observe the further product documentation!



Item no.: 2009-182

Testing tap; for max. 2.5 mm²; tool-free connection for individual test wires 0.08 - 2.5 mm; gray

www.wago.com/2009-182



Item no.: 2006-511

Modular TOPJOB®S connector; modular; for jumper contact slot; 1-pole; 6,00 mm²; gray

www.wago.com/2006-511



Item no.: 2006-549

Spacer module; modular; e.g., for bridging commoned terminal blocks; gray

www.wago.com/2006-549



Item no.: 210-136

Test plug; 2 mm Ø; with 500 mm cable; red

www.wago.com/210-136

Cover

Cover



Item no.: 2006-191

Lockout cap; for wire insertion and actuating opening; gray

www.wago.com/2006-191

Tool

Operating tool



Item no.: 210-721

Operating tool; Blade: 5.5 x 0.8 mm; with a partially insulated shaft; multicoloured

www.wago.com/210-721

End plate

End plate



Item no.: 2006-1293

Separator plate; 2 mm thick; oversized; gray

www.wago.com/2006-1293



Item no.: 2006-1294

Separator plate; 2 mm thick; oversized; orange

www.wago.com/2006-1294

Mounting

Mounting accessories



Item no.: 709-156

Cover; Type 3; suitable for cover carrier, type 3; 1 m long; transparent

www.wago.com/709-156



Item no.: 709-169

Cover carrier; Type 3; gray

www.wago.com/709-169

Carrier rail

Mounting accessories



Item no.: 210-197

Steel carrier rail; 35 x 15 mm; 1.5 mm thick; 2 m long; slotted; similar to EN 60715; silver-colored

www.wago.com/210-197

Item no.: 210-198

Subject to changes. Please also observe the further product documentation!

WAGO GmbH & Co. KG

Hansastr. 27

32423 Minden

Phone: +49571 887-0 | Fax: +49571 887-169





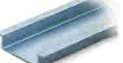

Email: info.de@wago.com | Web: www.wago.com

Do you have any questions about our products?

We are always happy to take your call at +49 (571) 887-44222.

	Copper carrier rail; 35 x 15 mm; 2.3 mm thick; 2 m long; unslotted; according to EN 60715; copper-colored	www.wago.com/210-198
	Item no.: 210-113 Steel carrier rail; 35 x 7.5 mm; 1 mm thick; 2 m long; unslotted; according to EN 60715; silver-colored	www.wago.com/210-113
	Item no.: 210-118 Steel carrier rail; 35 x 15 mm; 2.3 mm thick; 2 m long; unslotted; according to EN 60715; silver-colored	www.wago.com/210-118
	Item no.: 210-112 Steel carrier rail; 35 x 7.5 mm; 1 mm thick; 2 m long; slotted; according to EN 60715; "Hole width 25 mm; silver-colored	www.wago.com/210-112
	Item no.: 210-114 Steel carrier rail; 35 x 15 mm; 1.5 mm thick; 2 m long; unslotted; similar to EN 60715; silver-colored	www.wago.com/210-114
	Item no.: 210-115 Steel carrier rail; 35 x 7.5 mm; 1 mm thick; 2 m long; slotted; according to EN 60715; "Hole width 18 mm; silver-colored	www.wago.com/210-115
	Item no.: 210-196 Aluminum carrier rail; 35 x 8.2 mm; 1.6 mm thick; 2 m long; unslotted; similar to EN 60715; silver-colored	www.wago.com/210-196

Marking accessories

Marking strip		
	Item no.: 2009-110 Marking strips; for Smart Printer; on reel; not stretchable; plain; snap-on type; white	www.wago.com/2009-110
Marker carrier		
	Item no.: 2009-198 Adaptor; gray	www.wago.com/2009-198
Marker		
	Item no.: 2009-115/000-002 WMB-Inline; for Smart Printer; 1500 pieces on roll; stretchable 5 - 5.2 mm; plain; snap-on type; yellow	www.wago.com/2009-115/000-002
	Item no.: 2009-115/000-007 WMB-Inline; for Smart Printer; 1500 pieces on roll; stretchable 5 - 5.2 mm; plain; snap-on type; gray	www.wago.com/2009-115/000-007
	Item no.: 2009-115/000-017 WMB-Inline; for Smart Printer; 1500 pieces on roll; stretchable 5 - 5.2 mm; plain; snap-on type; light green	www.wago.com/2009-115/000-017
	Item no.: 2009-115/000-023 WMB-Inline; for Smart Printer; 1500 pieces on roll; stretchable 5 - 5.2 mm; plain; snap-on type; green	www.wago.com/2009-115/000-023

Subject to changes. Please also observe the further product documentation!



Item no.: 2009-115/000-024

WMB-Inline; for Smart Printer; 1500 pieces on roll; stretchable 5 - 5.2 mm; plain; snap-on type; violet

www.wago.com/2009-115/000-024

Item no.: 2009-145/000-006

Mini-WSB Inline; for Smart Printer; 1700 pieces on roll; stretchable 5 - 5.2 mm; plain; snap-on type; blue

www.wago.com/2009-145/000-006

Item no.: 2009-145

Mini-WSB Inline; for Smart Printer; 1700 pieces on roll; stretchable 5 - 5.2 mm; plain; snap-on type; white

www.wago.com/2009-145

Item no.: 2009-145/000-002

Mini-WSB Inline; for Smart Printer; 1700 pieces on roll; stretchable 5 - 5.2 mm; plain; snap-on type; yellow

www.wago.com/2009-145/000-002

Item no.: 2009-145/000-007

Mini-WSB Inline; for Smart Printer; 1700 pieces on roll; stretchable 5 - 5.2 mm; plain; snap-on type; gray

www.wago.com/2009-145/000-007

Item no.: 2009-145/000-005

Mini-WSB Inline; for Smart Printer; 1700 pieces on roll; stretchable 5 - 5.2 mm; plain; snap-on type; red

www.wago.com/2009-145/000-005

Item no.: 2009-145/000-012

Mini-WSB Inline; for Smart Printer; 1700 pieces on roll; stretchable 5 - 5.2 mm; plain; snap-on type; orange

www.wago.com/2009-145/000-012

Item no.: 2009-145/000-023

Mini-WSB Inline; for Smart Printer; 1700 pieces on roll; stretchable 5 - 5.2 mm; plain; snap-on type; green

www.wago.com/2009-145/000-023

Item no.: 2009-145/000-024

Mini-WSB Inline; for Smart Printer; 1700 pieces on roll; stretchable 5 - 5.2 mm; plain; snap-on type; violet

www.wago.com/2009-145/000-024



Item no.: 2009-115

WMB-Inline; for Smart Printer; 1500 pieces on roll; stretchable 5 - 5.2 mm; plain; snap-on type; white

www.wago.com/2009-115



Item no.: 248-501/000-006

Mini-WSB marking card; as card; not stretchable; plain; snap-on type; blue

www.wago.com/248-501/000-006



Item no.: 248-501/000-007

Mini-WSB marking card; as card; not stretchable; plain; snap-on type; gray

www.wago.com/248-501/000-007



Item no.: 248-501/000-002

Mini-WSB marking card; as card; not stretchable; plain; snap-on type; yellow

www.wago.com/248-501/000-002

Subject to changes. Please also observe the further product documentation!

WAGO GmbH & Co. KG

Hansastr. 27

32423 Minden

Phone: +49571 887-0 | Fax: +49571 887-169

Email: info.de@wago.com | Web: www.wago.com

Do you have any questions about our products?

We are always happy to take your call at +49 (571) 887-44222.



Item no.: 248-501/000-012
Mini-WSB marking card; as card; not stretchable; plain; snap-on type; orange

www.wago.com/248-501/000-012



Item no.: 248-501
Mini-WSB marking card; as card; not stretchable; plain; snap-on type; white

www.wago.com/248-501



Item no.: 248-501/000-017
Mini-WSB marking card; as card; not stretchable; plain; snap-on type; light green

www.wago.com/248-501/000-017



Item no.: 248-501/000-005
Mini-WSB marking card; as card; not stretchable; plain; snap-on type; red

www.wago.com/248-501/000-005



Item no.: 248-501/000-024
Mini-WSB marking card; as card; not stretchable; plain; snap-on type; violet

www.wago.com/248-501/000-024



Item no.: 248-501/000-023
Mini-WSB marking card; as card; not stretchable; plain; snap-on type; green

www.wago.com/248-501/000-023

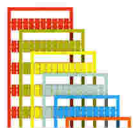

Item no.: 793-5501/000-007
WMB marking card; as card; for terminal block width 5 - 17.5 mm; stretchable 5 - 5.2 mm; plain; snap-on type; gray

www.wago.com/793-5501/000-007

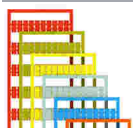

Item no.: 793-5501/000-012
WMB marking card; as card; for terminal block width 5 - 17.5 mm; stretchable 5 - 5.2 mm; plain; snap-on type; orange

www.wago.com/793-5501/000-012



Item no.: 793-5501/000-017
WMB marking card; as card; for terminal block width 5 - 17.5 mm; stretchable 5 - 5.2 mm; plain; snap-on type; green

www.wago.com/793-5501/000-017

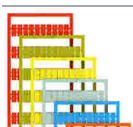

Item no.: 793-5501/000-023
WMB marking card; as card; for terminal block width 5 - 17.5 mm; stretchable 5 - 5.2 mm; plain; snap-on type; light green

www.wago.com/793-5501/000-023

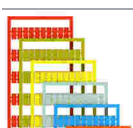

Item no.: 793-5501/000-024
WMB marking card; as card; for terminal block width 5 - 17.5 mm; stretchable 5 - 5.2 mm; plain; snap-on type; violet

www.wago.com/793-5501/000-024

Subject to changes. Please also observe the further product documentation!



Item no.: 793-501/000-002
WMB marking card; as card; not stretchable; plain; snap-on type; yellow

www.wago.com/793-501/000-002



Item no.: 793-501/000-007
WMB marking card; as card; not stretchable; plain; snap-on type; gray

www.wago.com/793-501/000-007



Item no.: 793-501/000-017
WMB marking card; as card; not stretchable; plain; snap-on type; light green

www.wago.com/793-501/000-017



Item no.: 793-501/000-012
WMB marking card; as card; not stretchable; plain; snap-on type; orange

www.wago.com/793-501/000-012



Item no.: 793-501/000-023
WMB marking card; as card; not stretchable; plain; snap-on type; green

www.wago.com/793-501/000-023



Item no.: 793-501/000-006
WMB marking card; as card; not stretchable; plain; snap-on type; blue

www.wago.com/793-501/000-006



Item no.: 793-501/000-005
WMB marking card; as card; not stretchable; plain; snap-on type; red

www.wago.com/793-501/000-005



Item no.: 793-501
WMB marking card; as card; not stretchable; plain; snap-on type; white

www.wago.com/793-501

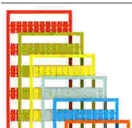

Item no.: 793-501/000-024
WMB marking card; as card; not stretchable; plain; snap-on type; violet

www.wago.com/793-501/000-024

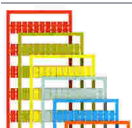

Item no.: 793-5501/000-005
WMB marking card; as card; for terminal block width 5 - 17.5 mm; stretchable 5 - 5.2 mm; plain; snap-on type; red

www.wago.com/793-5501/000-005

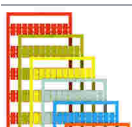

Item no.: 793-5501/000-002
WMB marking card; as card; for terminal block width 5 - 17.5 mm; stretchable 5 - 5.2 mm; plain; snap-on type; yellow

www.wago.com/793-5501/000-002

Subject to changes. Please also observe the further product documentation!



Item no.: 793-5501/000-006

WMB marking card; as card; for terminal block width 5 - 17.5 mm; stretchable 5 - 5.2 mm; plain; snap-on type; blue www.wago.com/793-5501/000-006



Item no.: 793-5501

WMB marking card; as card; for terminal block width 5 - 17.5 mm; stretchable 5 - 5.2 mm; plain; snap-on type; white www.wago.com/793-5501



Item no.: 2009-115/000-012

WMB-Inline; for Smart Printer; 1500 pieces on roll; stretchable 5 - 5.2 mm; plain; snap-on type; orange www.wago.com/2009-115/000-012



Item no.: 2009-115/000-006

WMB-Inline; for Smart Printer; 1500 pieces on roll; stretchable 5 - 5.2 mm; plain; snap-on type; blue www.wago.com/2009-115/000-006

Group marker carrier



Item no.: 2009-193

Group marker carrier www.wago.com/2009-193



Item no.: 2009-192

Group marker carrier www.wago.com/2009-192



Item no.: 2009-191

Group marker carrier www.wago.com/2009-191

Downloads

Documentation

Bid Text

2206-1204 docx - Datei	2019. 4. 15.	docx 15.4 kB	Download
2206-1204 X81 - Datei	2019. 4. 15.	xml 4.1 kB	Download

Additional Information

		pdf 81.0 kB	Download
		pdf 125.0 kB	Download
Technical explanations		pdf 2.2 MB	Download

Subject to changes. Please also observe the further product documentation!

CAD/CAE-Data

CAE data

ZUKEN Portal 2206-1204	URL	Download
EPLAN Data Portal 2206-1204	URL	Download

CAD data

2D/3D Models 2206-1204	URL	Download
------------------------	---------------------	--------------------------

Environmental Product Compliance

Compliance Search

Environmental Product Compliance 2206-1204	URL	Download
--	---------------------	--------------------------

2-conductor through terminal block; with push-button; 6 mm²; with test port; suitable for Ex i applications; side and center marking; for DIN-rail 35 x 15 and 35 x 7.5; Push-in CAGE CLAMP®; 6,00 mm²; blue

Installation Notes

Conductor termination

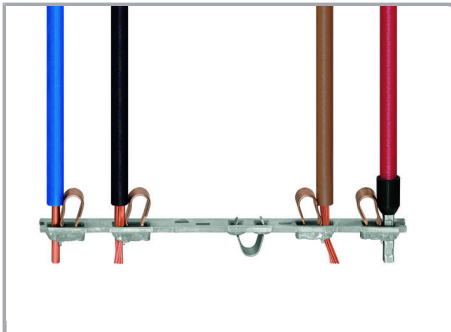

All conductor types at a glance

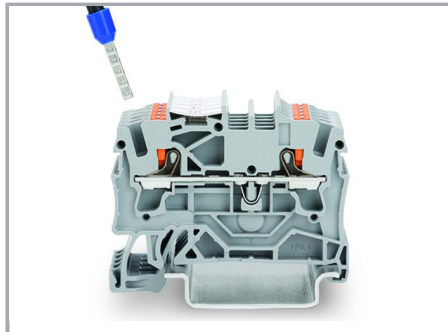

Push-in termination of solid and ferruled conductors



Insert fine-stranded conductors via operating tool.

Subject to changes. Please also observe the further product documentation!



Removing all conductors via operating tool.

Commoning

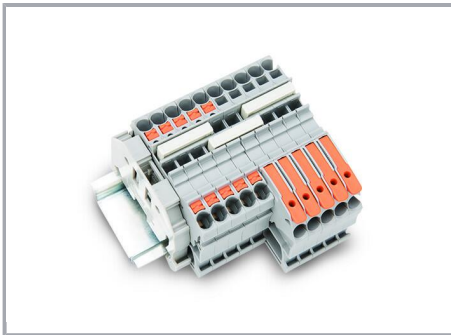

Insert a push-in type jumper bar and push down until it hits the backstop.



Commoning with step-down jumpers.



Step-down jumper (2006-499) commons 6 /4 mm² (10/12 AWG) terminal blocks (2206 /2204 Series) with 4/2.5/1.5 mm² (AWG 12/14 /16) terminal blocks (2204/2202/2201 Series).

Testing

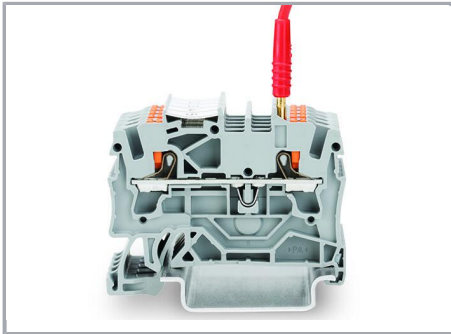

Testing with a 2 mm Ø test plug (max. 42 V).

Marking

Subject to changes. Please also observe the further product documentation!

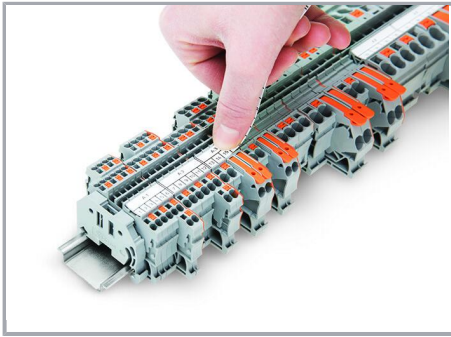

Snapping a marking strip into a marker slot.

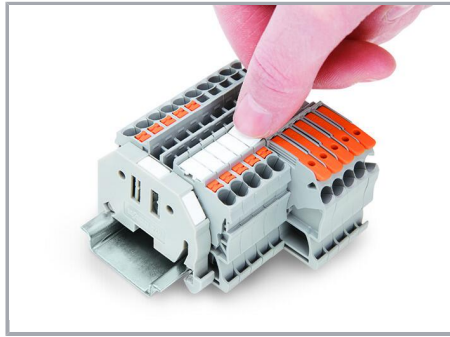

Snapping a marking strip into the marker slot.

Product family

TOPJOB® S

TOPJOB® S: In various industrial applications and modern building installations, WAGO's wide and versatile range of rail-mount terminal blocks provides more than just reliable electrical connections.

[Show all products from the family](#)

Subject to changes. Please also observe the further product documentation!