

# **SPECIFICATIONS**

<b>MODEL</b>	<b>RED LAMP LED</b>
<b>PART NO.</b>	<b>LR530A</b>

## [Contents]

1.	Devices -----	2
2.	Outline Dimensions -----	2
3.	Absolute Maximum Ratings -----	3
4.	Electro-Optical Characteristics -----	4
5.	Reliability Tests -----	5
6.	Characteristic Diagrams -----	6
7.	Bin Code Description -----	8
8.	Packing -----	9
9.	Soldering Profile -----	12
10.	Reference -----	13
11.	Precaution For Use -----	14

<050201> Rev. 0.0

LR530A



**SEOUL SEMICONDUCTOR CO., LTD.**

148-29, Kasan-Dong, Keumchun-Gu, Seoul, Korea

TEL : 82-2-3281-6269 FAX : 82-2-857-5430

## 1. DEVICES

Part Number	Lens		Source	
	Color	Diffusion	Dice Source	Color
LR530A	Water Clear	Non-Diffused	AllnGaP/GaP	Red

## 2. OUTLINE DEMENSIONS

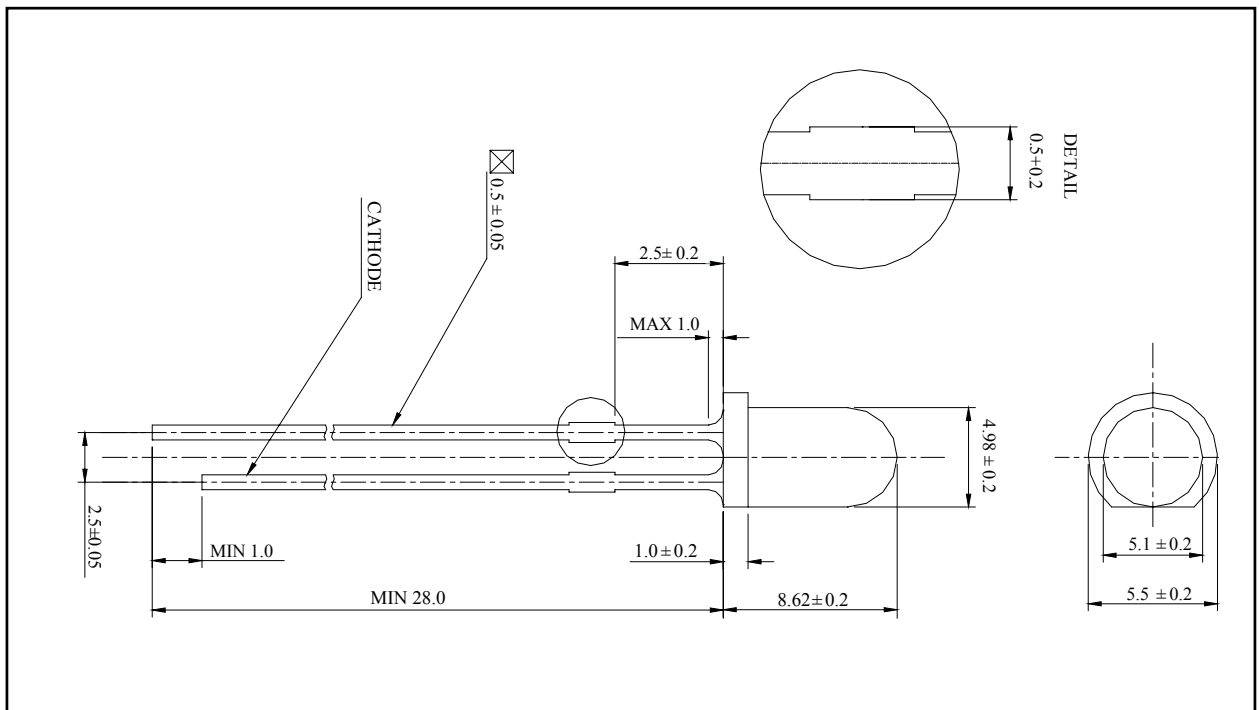

- Notes : 1. All dimensions are in millimeters.  
 2. Protruded epoxy is 1.0mm maximum.

<050201> Rev. 0.0

LR530A



**SEOUL SEMICONDUCTOR CO., LTD.**

148-29, Kasan-Dong, Keumchun-Gu, Seoul, Korea  
 TEL : 82-2-3281-6269 FAX : 82-2-857-5430

### 3. ABSOLUTE MAXIMUM RATINGS (at $T_a = 25^\circ\text{C}$ )

Item	Symbol	Value	Unit
DC Forward Current	$I_F$	30	mA
Forward Peak Pulse Current	$I_{FP}^1$	100	mA
Reverse Voltage	$V_R$	5	V
Power Dissipation	$P_D$	90	mW
Operating Temperature	$T_{opr}$	-40 ~ 100	$^\circ\text{C}$
Storage Temperature	$T_{stg}$	-40 ~ 105	$^\circ\text{C}$
Solder Temperature	$T_S$	260 $^\circ\text{C}$ for 10 second <sup>2</sup>	$^\circ\text{C}$

Notes : 1.  $t \leq 0.1\text{ms}$ ,  $D = 1/10$

2. 3mm bellow seating plane



#### 4. ELECTRO-OPTICAL CHARACTERISTICS (at $I_F = 20\text{mA}$ , $T_a = 25^\circ\text{C}$ )

Item	Symbol	Value			Unit
		Min.	Typ.	Max.	
Luminous Intensity <sup>1</sup>	$I_V$	2000	3000	-	mcd
Dominant Wavelength	$\lambda_d$	622	625	630	nm
Forward Voltage	$V_F$	-	2.2	2.7	V
View Angle	$2\theta_{1/2}$	30			deg.
Reverse Current (at $V_R = 5\text{V}$ )	$I_R$	-	-	10	$\mu\text{A}$

Note : 1. Luminous Intensity Tolerance  $\pm 10\%$



## 5. RELIABILITY TESTS

Item	Condition	Note	Failures
Life Test	$T_a = RT, I_F = 30mA$	1000hrs	0/22
High Temperature Operating	$T_a = 100^{\circ}C, I_F = 10mA$	1000hrs	0/22
Low Temperature Operating	$T_a = -40^{\circ}C, I_F = 20mA$	1000hrs	0/22
Thermal Shock	$T_a = -40^{\circ}C$ (30min) ~ $105^{\circ}$ (30min) (Transfer time : 5sec, 1Cycle = 1hr)	100cycles	0/50
Temperature Cycle	$T_a = -40^{\circ}C$ (25min) ~ $25^{\circ}C$ (5min) ~ $105^{\circ}C$ (25min) ~ $25^{\circ}C$ (5min)	100cycles	0/50
Moisture Resistance Cycle	$T_a = 25^{\circ}C \sim 65^{\circ}C \sim -10^{\circ}C, RH = 90\%$ (1Cycle = 24hrs)	10cycles	0/50
Resistance to soldering Heat	$T_s = 260 \pm 5^{\circ}C, t = 10 \pm 1sec$	1 time	0/50
ESD (Human Body Model)	1kV, 1.5k $\Omega$ ; 100pF	1 time	0/22
High Temperature Storage	$T_a = 105^{\circ}C$	1000hrs	0/50
Low Temperature Storage	$T_a = -40^{\circ}C$	1000hrs	0/50
Temperature Humidity Storage	$T_a = 85^{\circ}C, RH = 85\%$	1000hrs	0/50
Temperature Humidity Operating	$T_a = 85^{\circ}C, RH = 85\%$ $I_F = 15mA$	100hrs	0/22

### < Judging Criteria For Reliability Tests >

$V_F$	USL <sup>1</sup> X 1.2
$I_R$	USL X 2.0
$I_V$	LSL <sup>2</sup> X 0.7

Notes : 1. USL : Upper Standard Level

2. LSL : Lower Standard Level.

<050201> Rev. 0.0

LR530A



**SEOUL SEMICONDUCTOR CO., LTD.**

148-29, Kasan-Dong, Keumchun-Gu, Seoul, Korea

TEL : 82-2-3281-6269 FAX : 82-2-857-5430

## 6. CHARACTERISTIC DIAGRAMS

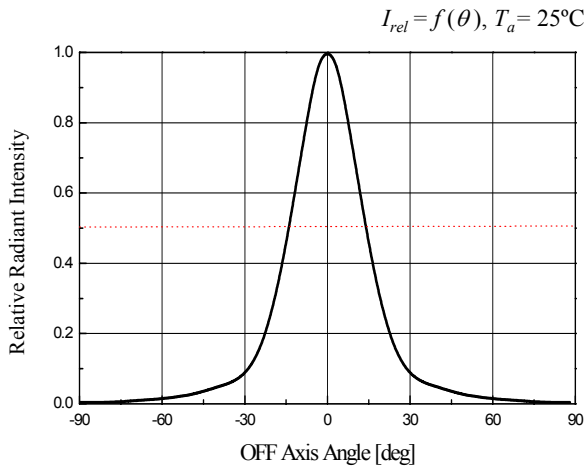

**Off Axis Angle vs. Relative Intensity**

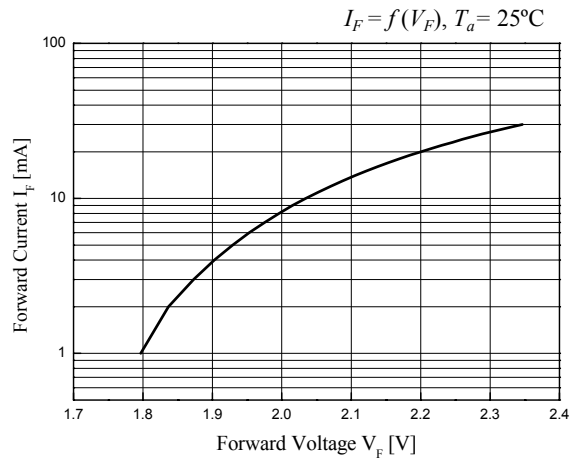

**Forward Voltage vs. Forward Current**

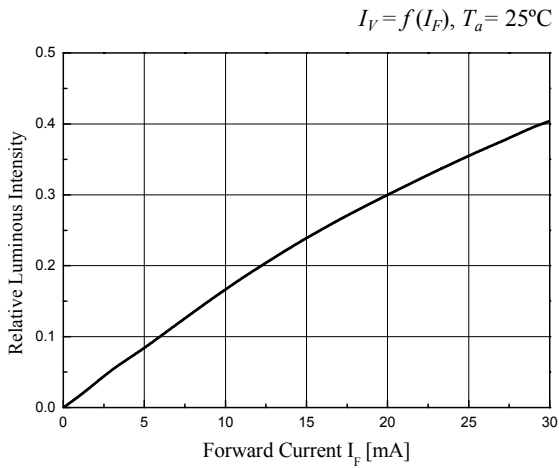

**Forward Current vs. Relative Intensity**

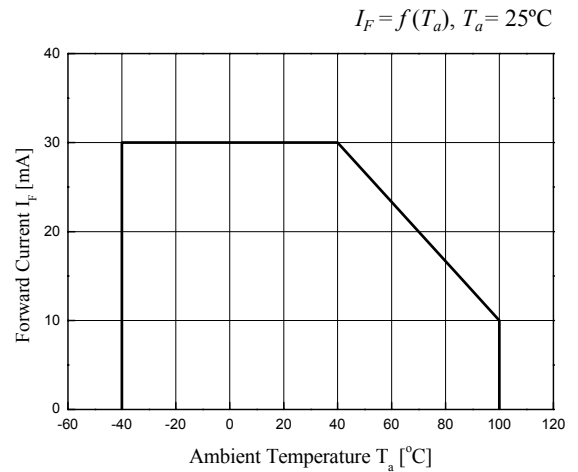

**Ambient Temperature vs. Forward Current**

<050201> Rev. 0.0

LR530A



**SEOUL SEMICONDUCTOR CO., LTD.**

148-29, Kasan-Dong, Keumchun-Gu, Seoul, Korea

TEL : 82-2-3281-6269 FAX : 82-2-857-5430

$$I_{rel} = f(\lambda_d), T_A = 25^\circ\text{C}, I_F = 20\text{mA}$$

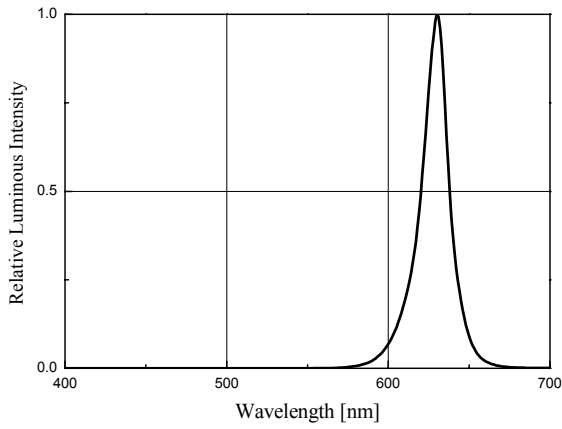

**Wavelength vs. Relative Intensity**

$$I_V/I_{V(25^\circ\text{C})} = f(T_A), I_F = 20\text{mA}$$

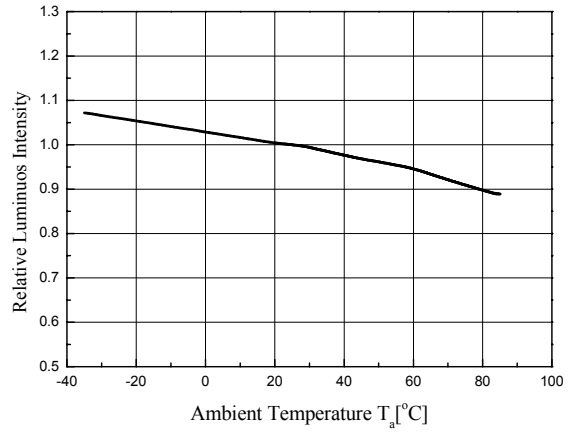

**Ambient Temperature vs. Relative Intensity**

<050201> Rev. 0.0

LR530A



**SEOUL SEMICONDUCTOR CO., LTD.**

148-29, Kasan-Dong, Keumchun-Gu, Seoul, Korea

TEL : 82-2-3281-6269 FAX : 82-2-857-5430

## 7. BIN CODE DESCRIPTION

BIN CODE		
Intensity	Color Ranks	Forward Voltage
A	1	1

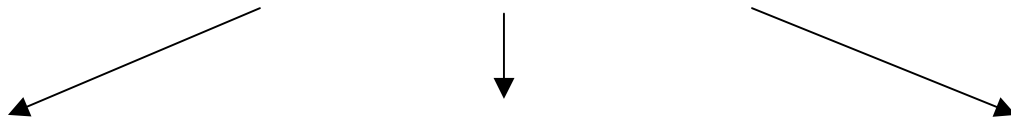

Intensity (mcd) @ $I_F = 20\text{mA}$			Dominant Wavelength (nm) @ $I_F = 20\text{mA}$			Forward Voltage (V) @ $I_F = 20\text{mA}$		
BIN CODE	Min.	Max.	BIN CODE	Min.	Max.	BIN CODE	Min.	Max.
A	2000	3000	1	622	624	1	2.0	2.2
C	3000	4000	2	624	630	2	2.2	2.4



## 8. PACKING

### 1) Bulk Packing

#### (1) Antistatic poly vinyl bag apply

Poly bag:

5φ Lamp Series : 500pcs

3φ Lamp Series : 500pcs

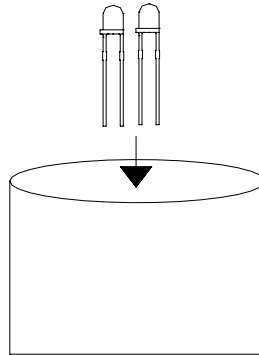

#### (2) Inner box structure

Box : 2 poly bags

		P/O No.	
Lot No.			
SEOUL SEMICONDUCTOR CO.,LTD TEL : (02) 3281-6269			

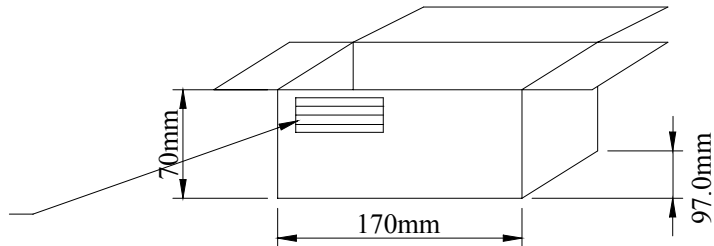

#### (3) Outer box structure

Box : 27 boxes

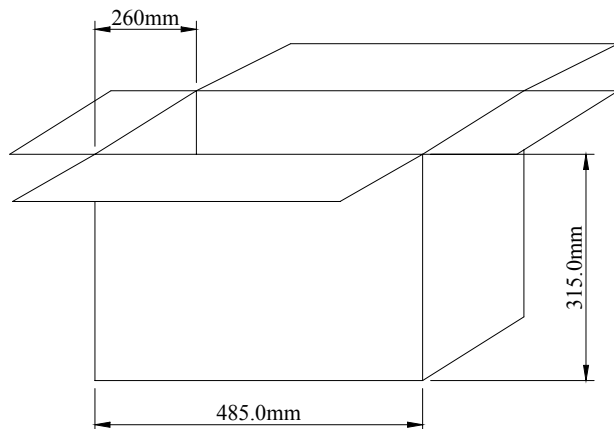

<050201> Rev. 0.0

LR530A



**SEOUL SEMICONDUCTOR CO., LTD.**

148-29, Kasan-Dong, Keumchun-Gu, Seoul, Korea

TEL : 82-2-3281-6269 FAX : 82-2-857-5430

## 2) Tapping Outline Dimensions

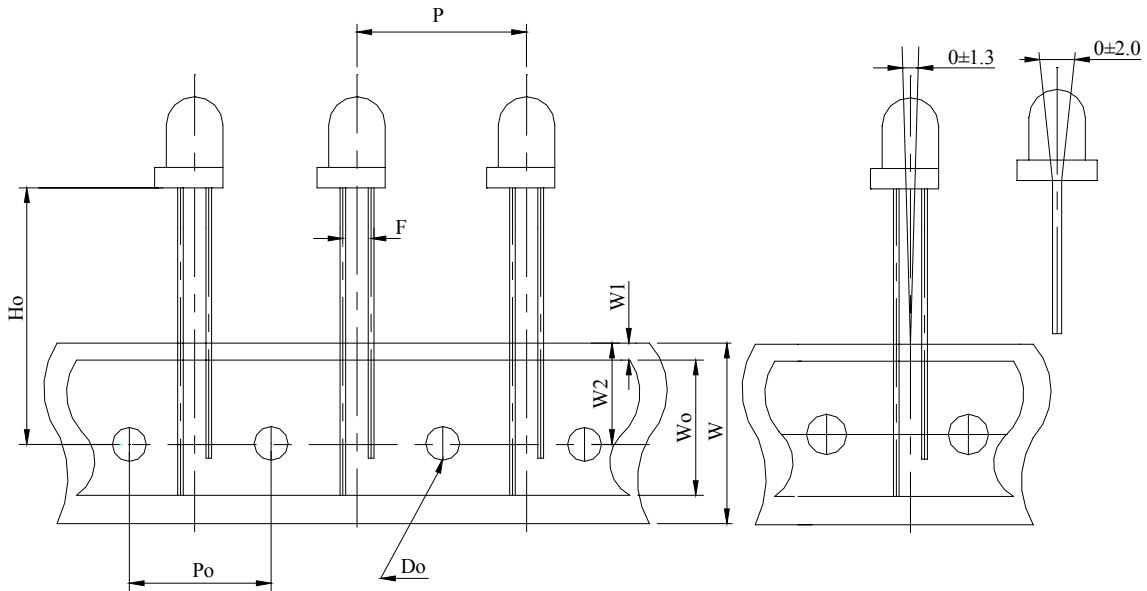

Package Dimensions (unit : mm)			
$H_o^*$		$P$	$12.7 \pm 0.5$
$W$	$18.0^{+1.0}_{-0.5}$	$P_o$	$12.7 \pm 0.3$
$W_o$	$13.0 \pm 0.3$	$F$	$2.54 \pm 0.5$
$W_1$	$1.0 \pm 0.5$	$D_o$	$\phi 4.0 \pm 0.5$
$W_2$	$9.0 \pm 0.5$		

\* Remark :  $H_o$  - users define.

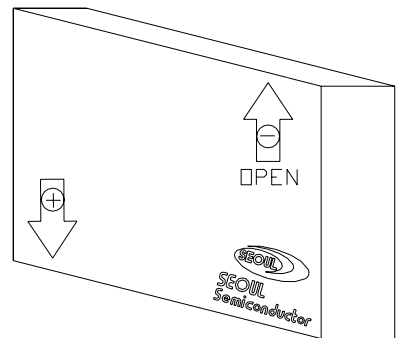

1 Box contain quantity.

\* 3 $\phi$  Series : 3000pcs

\* 5 $\phi$  Series : 2000pcs

### 3) Forming Outline Dimensions

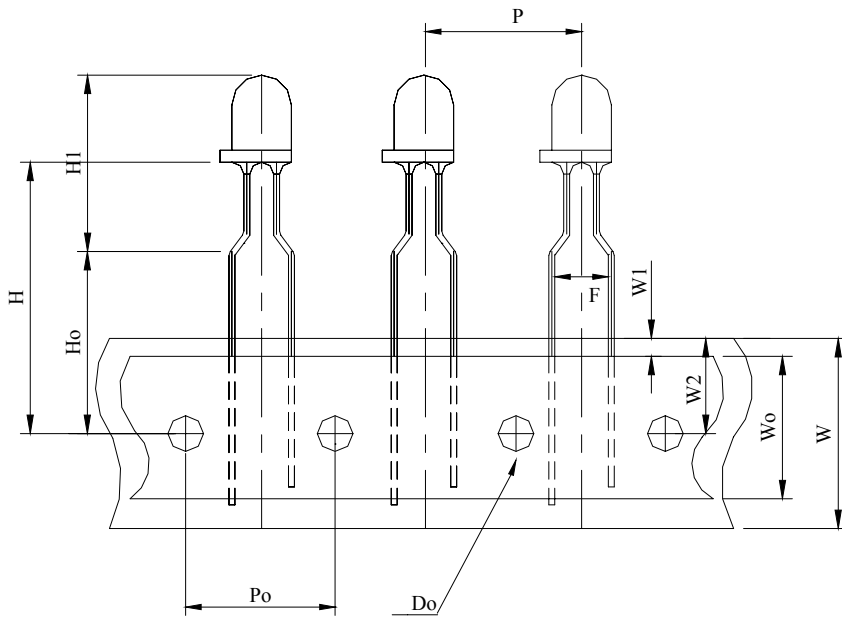

Package Dimensions (unit : mm)			
H *		W2	9.0±0.5
Ho *		P	12.7±0.5
H1 *		Po	12.7±0.3
W	18.0 <sup>+1.0</sup> <sub>-0.5</sub>	F	5.0±0.5
W0	13.0±0.3	Do	φ4.0±0.5
W1	1.0±0.5		

\* Remark : H / Ho / H1- users define.

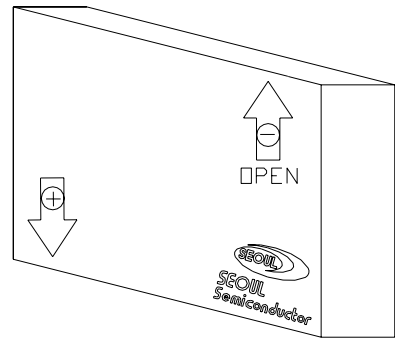

1 Box contain quantity.

\* 3φ Series : 2000pcs

\* 5φ Series : 1500pcs

## 9. SOLDERING PROFILE

### 1) Wave Soldering Conditions / Profile

- Preliminary heating to be at 85°C(120 °C max) for 20 seconds(60 seconds max).
- Soldering heat to be at 235 °C (260°C max) for 5 seconds (10 seconds max.)
- Soak time above 200 °C is 5 seconds

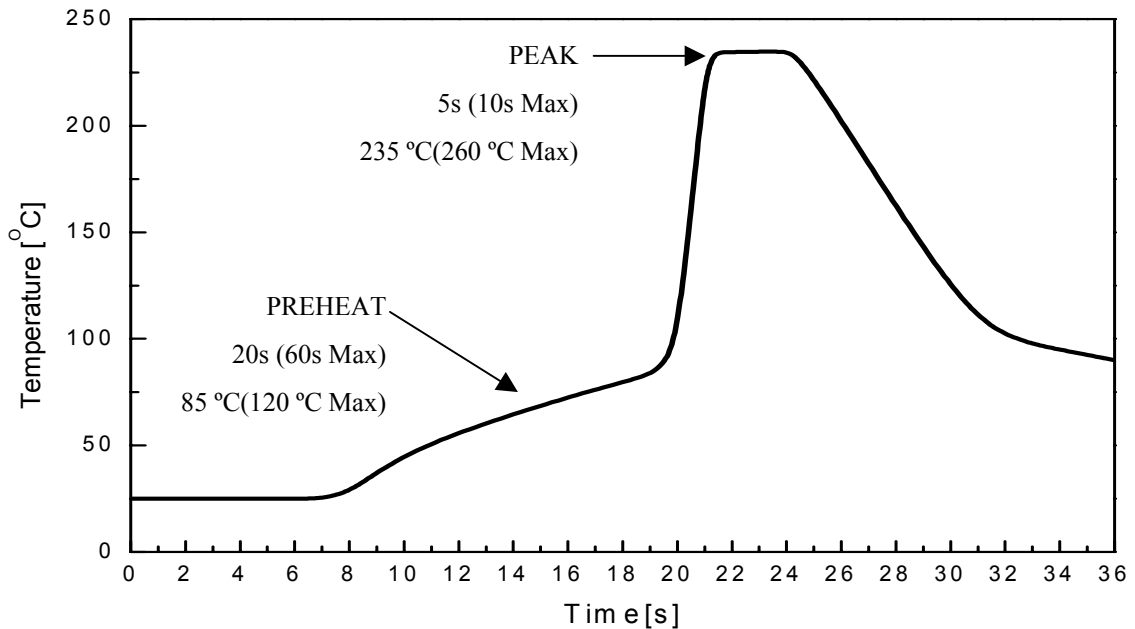

### 2) Hand Soldering conditions

- Not more than 5 seconds at max. 300°C, under Soldering iron.

Note : In case the soldered products are reused in soldering process, we don't guarantee the products.

## 10. PART NUMBERING SYSTEM

1	2	3	4	5	6	7	8		A	B	C
L	*	*	*	*	*	*	*	-	*	*	*

1) Lamp LED initial

2) Color

U : Ultra Violet,                      B : Blue (460~490),                      C : Cyan (490~510),

T : True Green (510~540), G : Yellow-Green (540~580)

Y : Yellow (580~600)                      O : Orange (600~620)                      R : Red (620~700)

W : White                                      M : Warm                                      I : Infrared

3) If the products have 2 or 3chips

GR : Green + Red ( according to wavelength), FL : Full color

4) Outline type

1 : 3x2(square),                      2 : 5x2(square),                      3 : Phi3,                      5 : Phi 5 ,

6 : 3Phi Oval,                      7 : 5Phi Oval

5) Half angle

1: ~14°, 2: 15~24°, 3: 25~34°, 4: 35~44°, 5 : 45~54°... 0 : more than 100°

6) 1<sup>st</sup> Development according to a chip

7) 2<sup>nd</sup> Development (other material)

D : diffused C : colored Z : zener chip attached

8) Stand off type

A, B, C : Bin cord description A: IV, B: WD C: VF

## 11. PRECAUTION FOR USE

- 1) In order to avoid the absorption of moisture, it is recommended to store in the dry box (or desiccators) with a desiccant .
- 2) In case of more than 1 week passed after opening or change color of indicator on desiccant components shall be dried 10-12Hr, at  $60\pm 5^{\circ}\text{C}$  .
- 3) In case of supposed the components is humid, shall be dried dip-solder just before, 12Hr at  $80\pm 5^{\circ}\text{C}$  or 10Hr at  $100\pm 5^{\circ}\text{C}$  .
- 4) Any mechanical force or any excess vibration shall not be accepted to apply during cooling process to normal temp. after soldering.
- 5) Quick cooling shall not be avoid.
- 6) Components shall not be mounted on warped direction of PCB.
- 7) Anti radioactive ray design is not considered for the products listed here in.
- 8) This device should not be used in any type of fluid such as water, oil, organic solvent and etc. When washing is required, IPA should be used.
- 9) When the LEDs are illuminating, operating current should be decided after considering the ambient maximum temperature.
- 10) LEDs must be stored to maintain a clean atmosphere. If the LEDs are stored for 3 months or more after being shipped from SSC, a sealed container with a nitrogen atmosphere should be used for storage.
- 11) The LEDs must be soldered within seven days after opening the moisture-proof packing.
- 12) Repack unused products with anti-moisture packing, fold to close any opening and then store in a dry place.
- 13) The appearance and specifications of the product may be modified for improvement without notice.

