

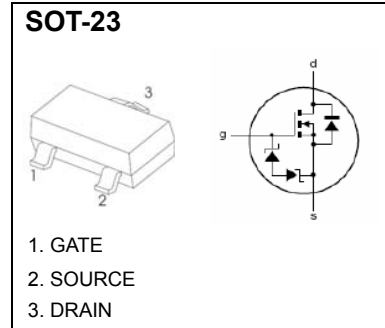

N-Channel Enhancement Mode MOSFET

Feature

- 60V/0.2A, $R_{DS(ON)} = 4\ \Omega$ (MAX) @ $V_{GS} = 10V$, $I_D = 0.5A$
 $R_{DS(ON)} = 4\ \Omega$ (MAX) @ $V_{GS} = 5V$, $I_D = 0.05A$
- Super High dense cell design for extremely low $R_{DS(ON)}$.
- Reliable and Rugged.
- SOT-23 for Surface Mount Package.
- ESD protected up to 2KV



Applications

- Power Management in Desktop Computer or DC/DC Converters .

Absolute Maximum Ratings

$T_A=25^\circ C$ Unless Otherwise noted

Parameter	Symbol	Limit	Units
Drain-Source Voltage	V_{DS}	60	V
Gate-Source Voltage	V_{GS}	± 15	V
Drain Current-Continuous	I_D	0.2	A

Electrical Characteristics

$T_A=25^\circ C$ Unless Otherwise noted

Parameter	Symbol	Test Conditions	Min	Typ.	Max	Units
Off Characteristics						
Drain to Source Breakdown Voltage	BVDSS	$V_{GS}=0V, I_D=10\mu A$	60	-	-	V
Zero-Gate Voltage Drain Current	IDSS	$V_{DS}=60V, V_{GS}=0V$	-	-	1	μA
Gate Body Leakage Current, Forward	IGSSF	$V_{GS}=15V, V_{DS}=0V$	-	-	1	μA
Gate Body Leakage Current, Reverse	IGSSR	$V_{GS}=-15V, V_{DS}=0V$	-	-	-1	μA
On Characteristics						
Gate Threshold Voltage	$V_{GS(th)}$	$V_{GS}=V_{DS}, I_D=250\mu A$	1.35	-		V
Static Drain-source On-Resistance *	$R_{DS(ON)}$	$V_{GS}=10V, I_D=0.5A$	-	2.5	4	Ω
		$V_{GS}=5V, I_D=0.05A$	-	2.5	4	Ω
Drain-Source Diode Characteristics and Maximum Ratings						
Drain-Source Diode Forward Voltage	VSD	$V_{GS}=0V, I_S=0.2A$			2.5	V

Notes :

*Pulse Test : Pulse Width $\leq 300\mu s$, Duty Cycle $\leq 2\%$.

N-Channel Enhancement Mode MOSFET

Typical Characteristics

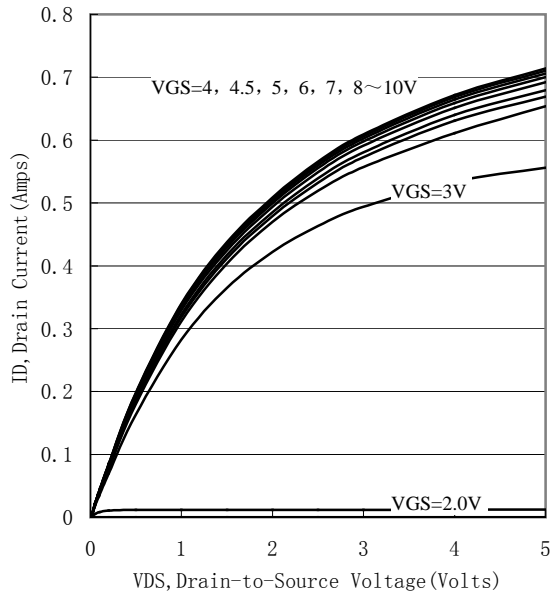

Figure 1. Output Characteristics

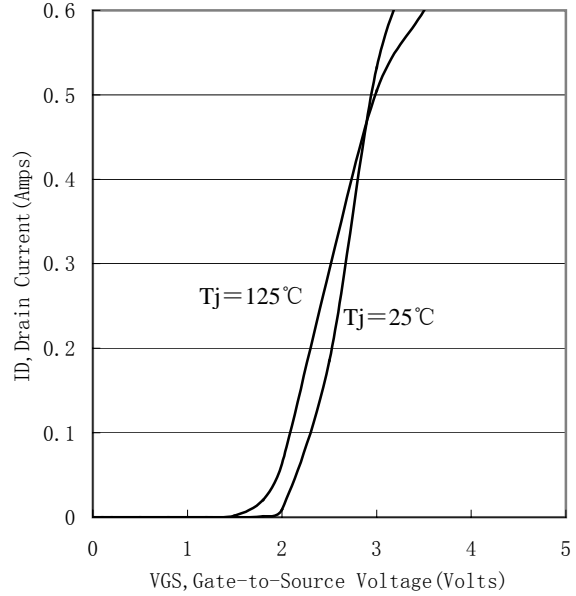

Figure 2. Transfer Characteristics

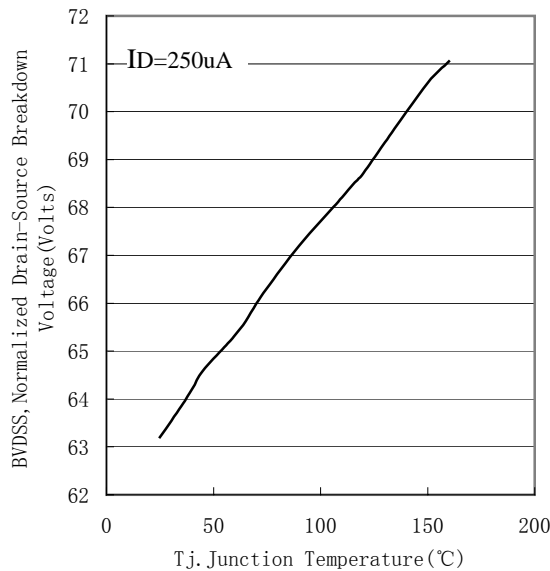

Figure 3. Breakdown Voltage Variation with Temperature

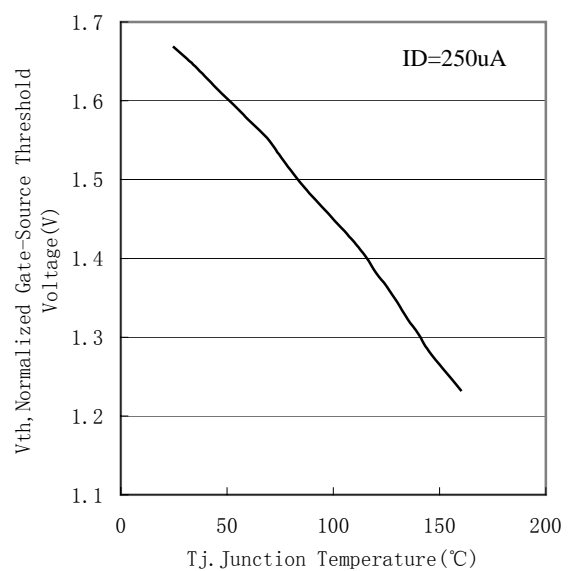

Figure 4. Gate Threshold Variation with Temperature

N-Channel Enhancement Mode MOSFET

Typical Characteristics

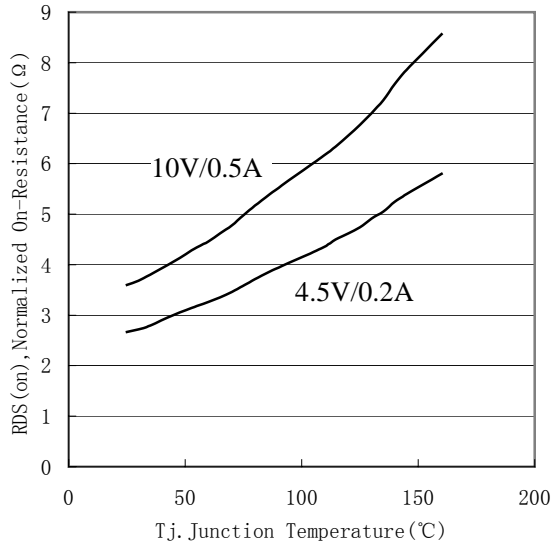

Figure 5. On-Resistance Variation with Temperature

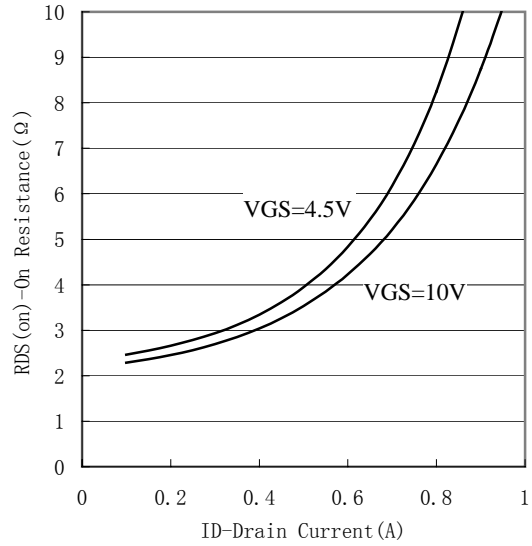

Figure 6. On-Resistance vs. Drain Current

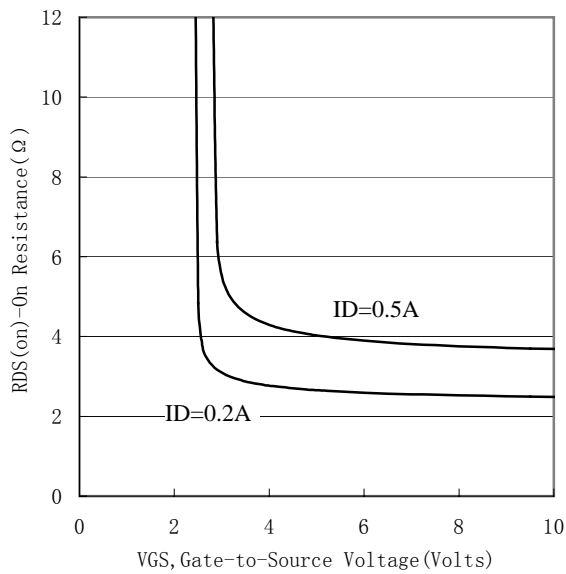

Figure 7. On-Resistance vs. Gate-to-Source Voltage

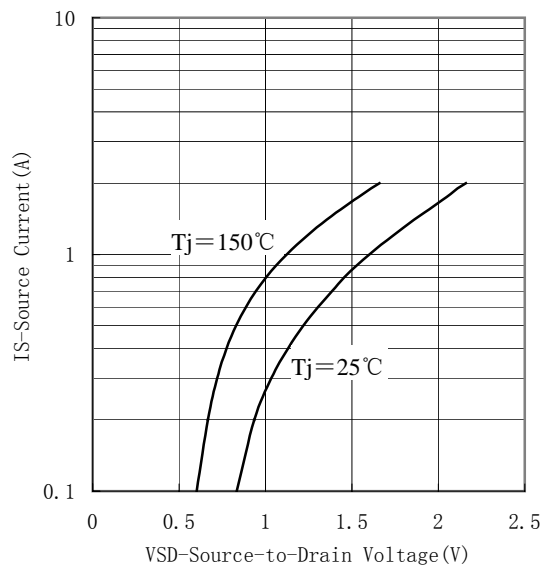

Figure 8. Source-Drain Diode Forward Voltage