

A-BRIGHT A-BRIGHT INDUSTRIAL CO., LTD. SURFACE MOUNT LED LAMPS

Full Color Chip LED Lamps

Part Number: AL-HUBG6B434T

Package outlines & Re-flow Profile

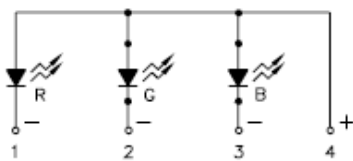
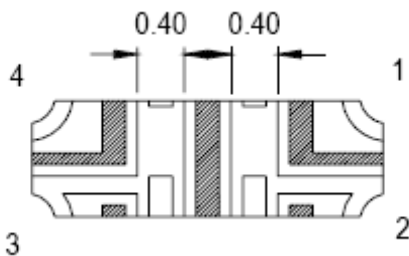
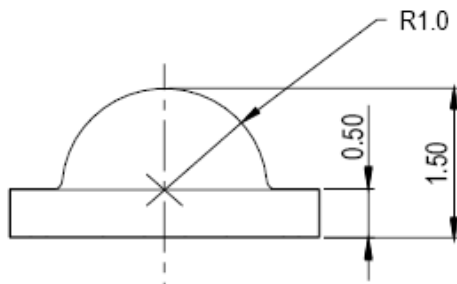
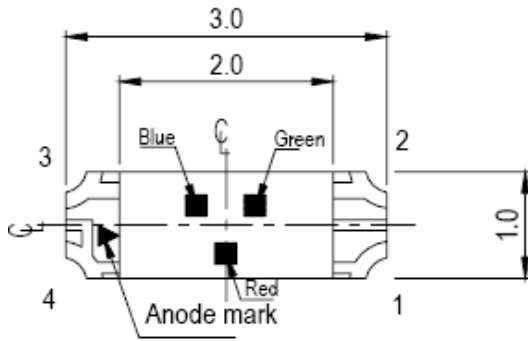

Polarity

For Reflow Soldering

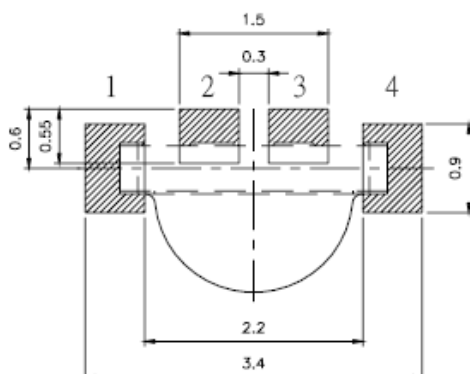

■ Reflow Temp/Time

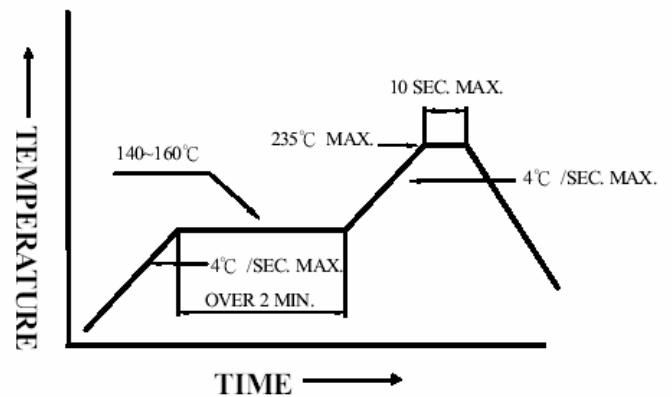

■ Soldering iron

Basic spec is ≤ 5 sec when 260°C . If temperature is higher, time should be shorter (+10°C \rightarrow -1sec). Power dissipation of iron should be smaller than 15W, and temperatures should be controllable . Surface temperature of the device should be under 230°C .

ITEM	MATERIALS
Resin (mold)	Epoxy
Lens color	Water Clear
Printed circuit board	BT
Dice	AlGaInP
	InGaN
	InGaN
Emitted color	Brilliant Red
	Brilliant Green
	Blue

NOTES:

1. All dimensions are in millimeters (inches).
2. Tolerances are ± 0.1 mm (0.004inch) unless otherwise noted.
3. Polarity referring onto the cathode mark is reversed on the red.

A-BRIGHT A-BRIGHT INDUSTRIAL CO., LTD.
SURFACE MOUNT LED LAMPS

Part Number: AL-HUBG6B434T

ELECTRO-OPTICAL CHARACTERISTICS

($T_A=25^{\circ}\text{C}$)

Parameter	Emitted Color	Test Condition	Symbol	Value			Unit
				MIN.	TYP.	MAX.	
Forward voltage	R	$I_F=20\text{mA}$	V_F	—	2.0	2.4	V
	G			—	3.2	3.6	
	B			—	3.2	3.6	
Luminous intensity	R	$I_F=20\text{mA}$	I_v	—	90	—	mcd
	G			—	180	—	
	B			—	50	—	
Wavelength	R	$I_F=20\text{mA}$	λ_p	632			nm
	G			518			
	B			468			
	R		λ_d	—	624	—	
	G			—	525	—	
	B			—	470	—	
Spectral Line Half-Width	R	$I_F=20\text{mA}$	$\Delta\lambda$	20			nm
	G			35			
	B			35			
Peak pulsing current (1/10 duty f=1kHz)	R	$I_F=20\text{mA}$	I_{FP}	60			mA
	G			100			
	B			100			
Power Dissipation	R	$I_F=20\text{mA}$	P_D	60			mW
	G			110			
	B			110			

Absolute maximum ratings

($T_A=25^{\circ}\text{C}$)

Parameter	Symbol	Value	Unit
Viewing angle at 50% I_v	$2\theta_{1/2}$	100	Deg
Forward current	I_F	25	mA
Reverse voltage	V_R	5	V
Reverse current	I_R	50	μA
Operating temperature range	Top	-40 ~ +85	$^{\circ}\text{C}$
Storage temperature range	Tstg	-40 ~ +90	$^{\circ}\text{C}$

A-BRIGHT A-BRIGHT INDUSTRIAL CO., LTD.
SURFACE MOUNT LED LAMPS

Part Number: AL-HUBG6B434T

Test items and results of reliability

NO	Item	Test Conditions	Test Hours/Cycle	Sample Size	Ac/Re
1	Solder Heat	TEMP : 260±5°C	5 Sec.	76 PCS	0/1
2	Temperature Cycle	H : +85°C 30min ┆ 5min L : -55°C 30min	50 CYCLES	76 PCS	0/1
3	Thermal Shock	H : +100°C 5min ┆ 10set L : -10°C 5min	50 CYCLES	76 PCS	0/1
4	High Temperature Storage	TEMP : 100°C	1000 HRS	76 PCS	0/1
5	Low Temperature Storage	TEMP : -55°C	1000 HRS	76 PCS	0/1
6	DC Operating Life	I _F =20mA	1000 HRS	76 PCS	0/1
7	High Temperature / High Humidity	85°C / 85%RH	1000 HRS	76 PCS	0/1

* Refer to reliability test standard specification for in this line.

A-BRIGHT A-BRIGHT INDUSTRIAL CO., LTD. SURFACE MOUNT LED LAMPS

Part Number: AL-HUBG6B434T

Typical Electro-Optical Characteristics Curves

◆ TYPICAL ELECTRICAL-OPTICAL CHARACTERISTICS CURVES

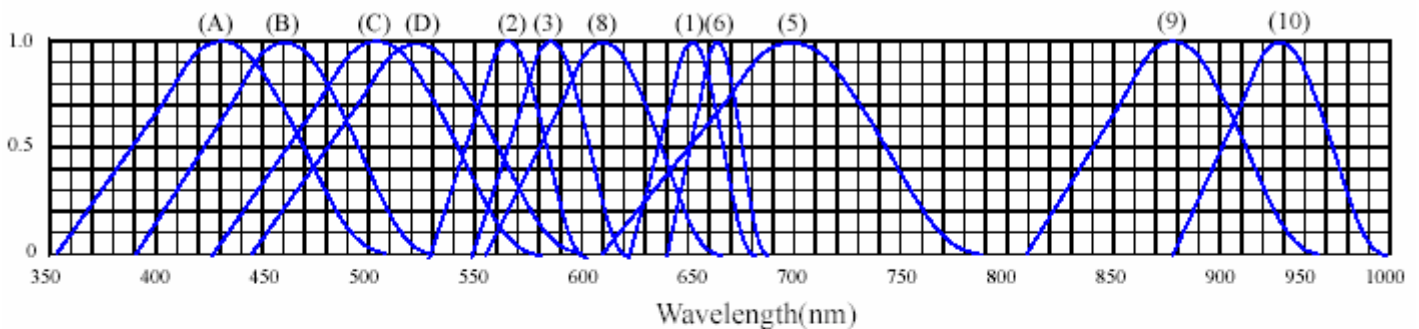
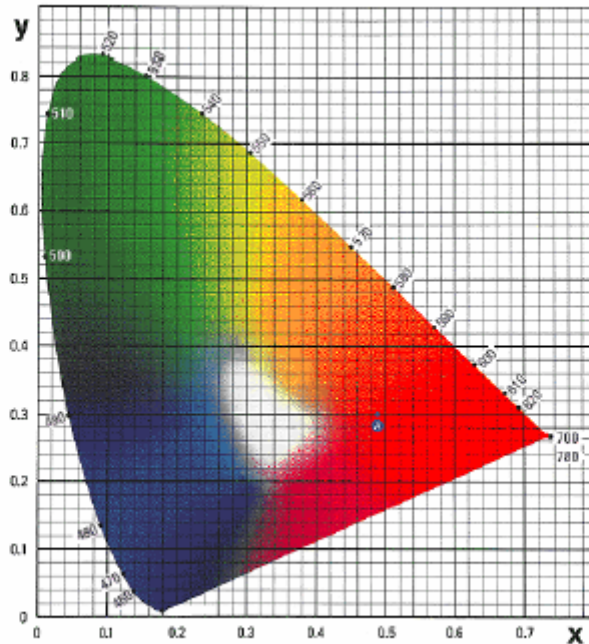

RELATIVE INTENSITY VS. WAVELENGTH(λ_p)

- | | |
|---|----------------------------------|
| (1) GaAsP/GaAs 655nm/Red | (9)- GaAlAs 880nm |
| (2) GaP 568nm/ Yellow Green | (10)-GaAs/GaAs&GaAlAs/GaAs 940nm |
| (3) GaAsP/GaP 585nm/Yellow | (A)- GaN 430nm/Blue |
| (4) GaAsP/GaP 635nm/Orange & Hi-Eff Red | (B)- InGaN 470nm/Blue |
| (5) GaP 700nm/Bright Red | (C)- InGaN 502nm/Ultra Green |
| (6) GaAlAs/GaAs 660nm/Super Red | (D)- InGaN 523nm/Ultra Green |
| (8) GaAsP/GaP 610nm/Super Red | |

A-BRIGHT A-BRIGHT INDUSTRIAL CO., LTD. SURFACE MOUNT LED LAMPS

Part Number: AL-HUBG6B434T

Typical Electro-Optical Characteristics Curves

◆ CHARACTERISTICS DIAGRAMS

FORWARD CURRENT VS. FORWARD VOLTAGE

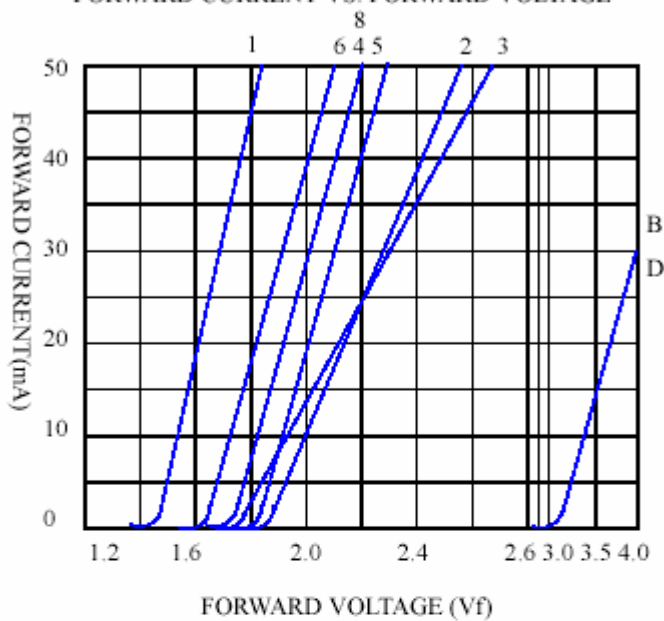

RELATIVE LUMINOUS INTENSITY VS. FORWARD CURRENT

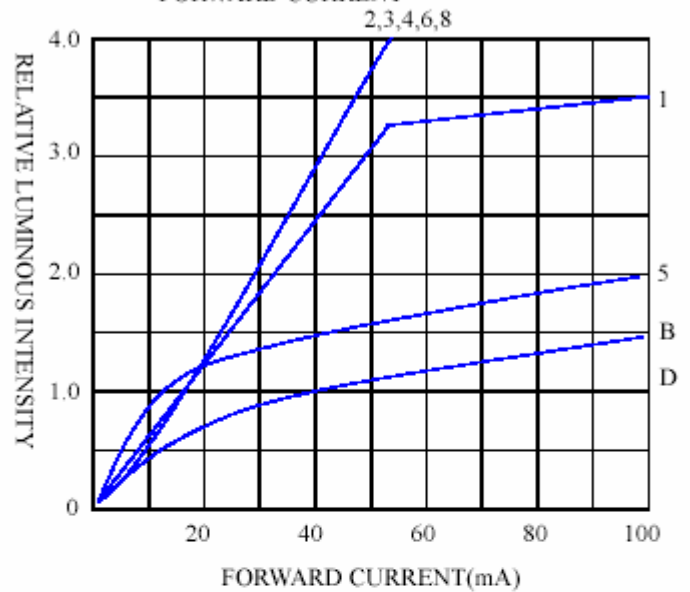

FORWARD CURRENT VS. AMBIENT TEMPERATURE

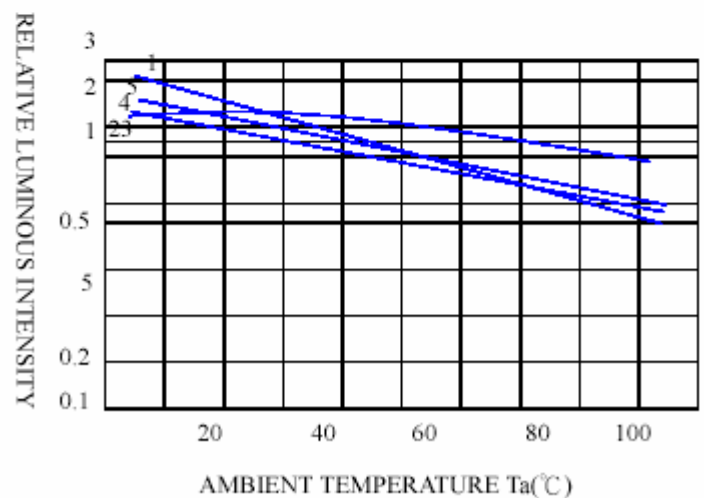
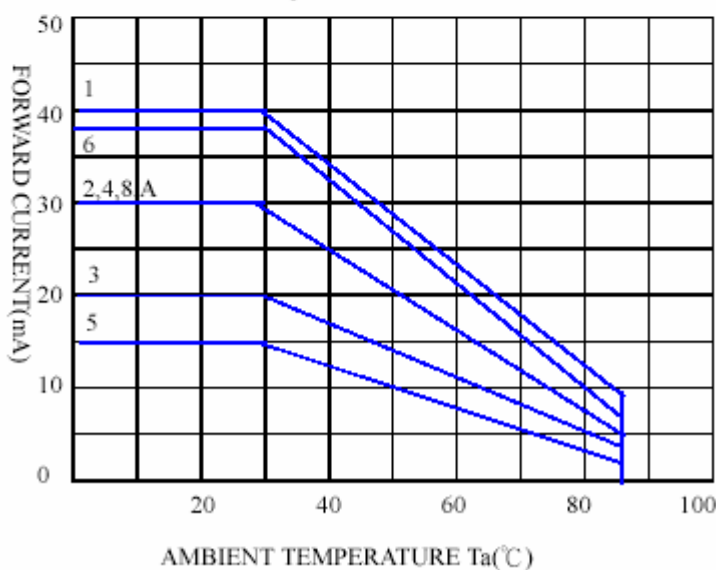

A-BRIGHT A-BRIGHT INDUSTRIAL CO., LTD. SURFACE MOUNT LED LAMPS

Part Number: AL-HUBG6B4343T

Precautions For Use

1. Over-current proof
Customer must apply resistors for protection, otherwise slight voltage shift will cause big current change (Burn out will happen).
2. Storage
 - 2.1 Do not open moisture proof bag before the products are ready to use.
 - 2.2 Before opening the package, the LEDs should be kept at 30°C or less and 90%RH or less.
 - 2.3 The LEDs should be used within a year.
 - 2.4 After opening the package, the LEDs should be kept at 30°C or less and 70%RH or less.
 - 2.5 The LEDs should be used within 168 hours (7 days) after opening the package.
 - 2.6 If the moisture absorbent material (silica gel) has faded away or the LEDs have exceeded the storage time, baking treatment should be performed using the following conditions.
Baking treatment : 60±5°C for 24 hours.

3. Soldering Condition

3.1 Pb-free solder temperature profile

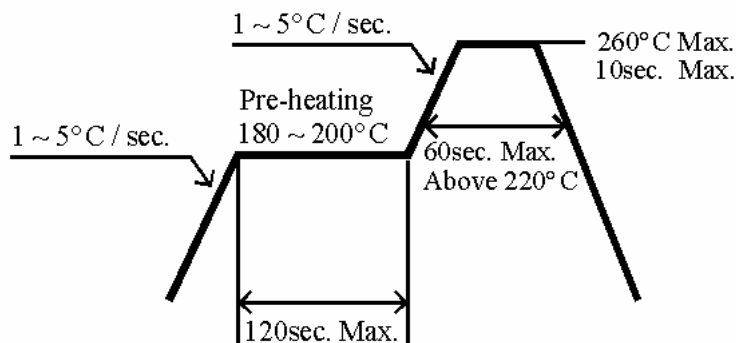

- 3.2 Reflow soldering should not be done more than two times.
- 3.3 When soldering, do not put stress on the LEDs during heating.
- 3.4 After soldering, do not warp the circuit board.

4. Soldering Iron

Each terminal is to go to the tip of soldering iron temperature less than 280°C for 3 seconds within once in less than soldering iron capacity 25W. Leave two seconds and more intervals, and do soldering of each terminal. Be careful because the damage of the product is often started at the time of the hand solder.