

2N3741

APPLICATIONS:

- Drivers
- Switches
- Medium-Power Amplifiers

FEATURES:

- Low Saturation Voltage: 0.6 V_{CE(sat)} @ I_C = 1.0 Amp
- High Gain Characteristics: hFE @ I_C = 250 mA: 30-100
- Excellent Safe Area Limits
- Complementary to NPN 2N3767 (2N3741)

**Medium Power
PNP Transistors**

DESCRIPTION:

These power transistors are produced by PPC's DOUBLE DIFFUSED PLANAR process. This technology produces high voltage devices with excellent switching speeds, frequency response, gain linearity, saturation voltages, high current gain, and safe operating areas. They are intended for use in Commercial, Industrial, and Military power switching, amplifier, and regulator applications.

Ultrasonically bonded leads and controlled die mount techniques are utilized to further increase the SOA capability and inherent reliability of these devices. The temperature range to 200°C permits reliable operation in high ambients, and the hermetically sealed package insures maximum reliability and long life.

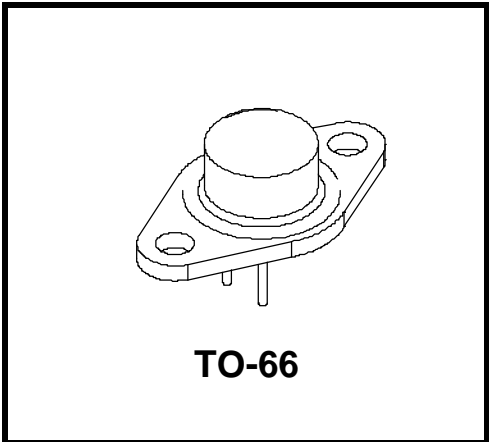

ABSOLUTE MAXIMUM RATINGS:

SYMBOL	CHARACTERISTIC	VALUE	UNITS
V _{CEO} *	Collector-Emitter Voltage	80	Vdc
V _{EB} *	Emitter-Base Voltage	7.0	Vdc
V _{CB} *	Collector-Base Voltage	80	Vdc
I _C *	Peak Collector Current	10	Adc
I _C *	Continuous Collector Current	4.0	Adc
I _B *	Base Current	2.0	Adc
T _{STG} *	Storage Temperature	-65 to 200	°C
T _J *	Operating Junction Temperature	-65 to 200	°C
P _D *	Total Device Dissipation	25	Watts
	T _C = 25°C		
	Derate above 25°C	0.143	W/°C
θ _{JC}	Thermal Impedance	7	°C/W

* Indicates JEDEC registered data.

**ELECTRICAL CHARACTERISTICS:
 (25° Case Temperature Unless Otherwise Noted)**

SYMBOL	CHARACTERISTIC	TEST CONDITIONS	VALUE		Units
			Min.	Max.	
$V_{CE(sus)}^*$	Collector-Emitter Sustaining Voltage	$I_C = 100 \text{ mAdc}, I_B = 0$ (Note 1)	80	----	Vdc
I_{EB0}^*	Emitter Base Cutoff Current	$V_{EB} = 7.0 \text{ Vdc}$	----	0.5	mAdc
I_{CEX}^*	Collector Cutoff Current	$V_{CE} = 80 \text{ Vdc}, V_{BE(off)} = 1.5 \text{ Vdc}$	----	100	μAdc
		$V_{CE} = 60 \text{ Vdc}, V_{BE(off)} = 1.5 \text{ Vdc}, T_C = 150^\circ\text{C}$	----	1.0	mAdc
I_{CE0}^*	Collector-Emitter Cutoff Current	$V_{CE} = 60 \text{ Vdc}, I_B = 0$	----	1.0	mAdc
I_{CB0}^*	Collector Base Cutoff Current	$V_{CB} = 80 \text{ Vdc}, I_E = 0$	----	100	μAdc
h_{FE}^*	DC Current Gain (Note 1)	$I_C = 100 \text{ mAdc}, V_{CE} = 1.0 \text{ Vdc}$	40	----	----
		$I_C = 250 \text{ mAdc}, V_{CE} = 1.0 \text{ Vdc}$	30	100	----
		$I_C = 500 \text{ mAdc}, V_{CE} = 1.0 \text{ Vdc}$	20	----	----
		$I_C = 1.0 \text{ Adc}, V_{CE} = 1.0 \text{ Vdc}$	10	----	----
$V_{CE(sat)}^*$	Collector-Emitter Saturation Voltage (Note 1)	$I_C = 1.0 \text{ Adc}, I_B = 125 \text{ mAdc}$	----	0.6	Vdc
V_{BE}^*	Base-Emitter Voltage (Note 1)	$I_C = 250 \text{ mAdc}, V_{CE} = 1.0 \text{ Vdc}$	----	1.0	Vdc
f_T^*	Current Gain Bandwidth Product	$I_C = 100 \text{ mAdc}, V_{CE} = 10 \text{ Vdc}, f = 1.0 \text{ MHz}$	3.0	----	MHz
h_{fe}^*	Small-Signal Current Gain	$I_C = 50 \text{ mAdc}, V_{CE} = 10 \text{ Vdc}, f = 1.0 \text{ kHz}$	25	----	----
C_{ob}^*	Common Base Output Capacitance	$V_{CB} = 10 \text{ Vdc}, I_C = 0, f = 100 \text{ kHz}$	----	100	pF

Note 1: Pulse Test: $PW \leq 300\mu\text{s}$, Duty Cycle $\leq 2.0\%$

* Indicates JEDEC registered data.

PACKAGE MECHANICAL DATA:

