

IoT OPTIMIZED LOW PROFILE QUARTZ CRYSTAL



ABM12W SERIES

1.6 x 1.2 x 0.4mm

 RoHS/RoHS II Compliant

MSL = N/A: NOT APPLICABLE

FEATURES

- Optimized for energy saving wearables and IoT applications
- Plated at exceptionally low plating capacitance, as low as 4pF, with optimized ESR
- 0.4 mm max height ideally suited for height constrained designs
- Seam sealed for longterm reliability

APPLICATIONS

- Wearables
- Internet of Things (IoT)
- Bluetooth/Bluetooth Low Energy (BLE)
- Wireless modules
- Machine-to-machine (M2M) connectivity
- Ultra-low power MCU
- Near Field Communication (NFC)
- ISM Band

STANDARD SPECIFICATIONS

Parameters	Minimum	Typical	Maximum	Units	Notes
Frequency Range	24.0000		52.0000	MHz	
Operation Mode	Fundamental				
Operating Temperature Range	-40		+125	°C	See options
Storage Temperature	-55		+125	°C	
Frequency Tolerance @ +25°C	-10		+10	ppm	See options
Frequency Stability over the Operating Temperature (ref. to +25°C)	-10		+10	ppm	See options
Equivalent series resistance (R1) (over -40°C to +125°C)		< 90	150	Ω	24.0000 – 31.9999MHz
		< 80	100		32.0000 – 36.9999MHz
		< 60	80		37.0000 – 52.0000MHz
Shunt capacitance (C0)		< 1.0	2.0	pF	
Load capacitance (CL)		4.0		pF	See options
Drive Level		10	100	μW	
Aging (1 year)	-2		+2	ppm	@ 25°C±3°C
Insulation Resistance	500			MΩ	@ 100Vdc ± 15V

IoT OPTIMIZED LOW PROFILE QUARTZ CRYSTAL

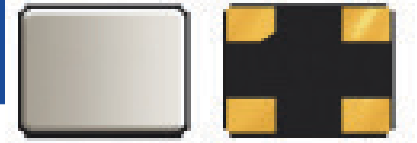

1.6 x 1.2 x 0.4mm



RoHS/RoHS II Compliant

MSL = N/A: NOT APPLICABLE

ABM12W SERIES

OPTIONS AND PART IDENTIFICATION (NOTE 1)

Note 1: Contact Abracon for part number requests with carrier frequency callouts up to 5 & 6 digit accuracy after the decimal.

ABM12W- [] MHz - [] - [] - [] - [] - []

Frequency in MHz
Please specify the Frequency in MHz out to **4 digit** accuracy after the decimal.
(e.g. 16.0000MHz)

Load Capacitance (pF)
8: 8pF
7: 7pF
6: 6pF
4: 4pF

Custom ESR
if other than standard
R □: Specify a value in Ω (e.g.: R70)

Operating Temp.
I: 0°C ~ 50°C
E: 0°C ~ +70°C
B: -20°C ~ +70°C
C: -30°C ~ +70°C
N: -30°C ~ +85°C
D: -40°C ~ +85°C
J: -40°C ~ +105°C (*)
K: -40°C ~ +125°C (*)

(*) Only offered @ Freq. Stability options: Z & Q.

Contact ABRACON for tighter Frequency Stability.

Freq. Tolerance
1: ± 10 ppm
7: ± 15 ppm
2: ± 20 ppm
3: ± 25 ppm
4: ± 30 ppm
5: ± 50 ppm

Packaging
Blank: Bulk
T3: 3kpcs / reel

Freq. Stability
U: ± 10 ppm (*)
G: ± 15 ppm (**)
X: ± 20 ppm (**)
W: ± 25 ppm (**)
Y: ± 30 ppm (**)
H: ± 35 ppm (**)
Z: ± 50 ppm
Q: ± 100 ppm

(*) Only offered @ Operating Temp. Range options: I, E, & B

(**) Only offered @ Operating Temp. Range options: I, E, B, C, N, & D

Contact ABRACON for wider Operating Temp. Range.

IoT OPTIMIZED LOW PROFILE QUARTZ CRYSTAL

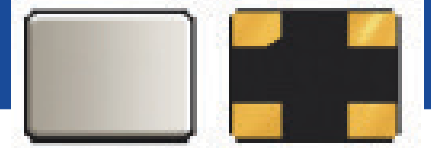

ABM12W SERIES

1.6 x 1.2 x 0.4mm



RoHS/RoHS II Compliant

MSL = N/A: NOT APPLICABLE

TYPICAL FREQUENCY Vs. TEMPERATURE CHARACTERISTICS

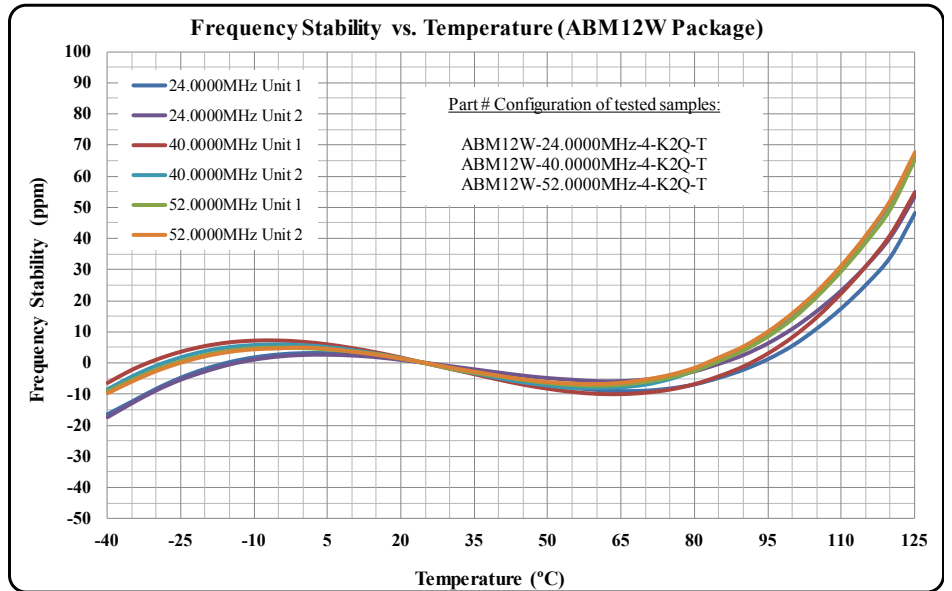
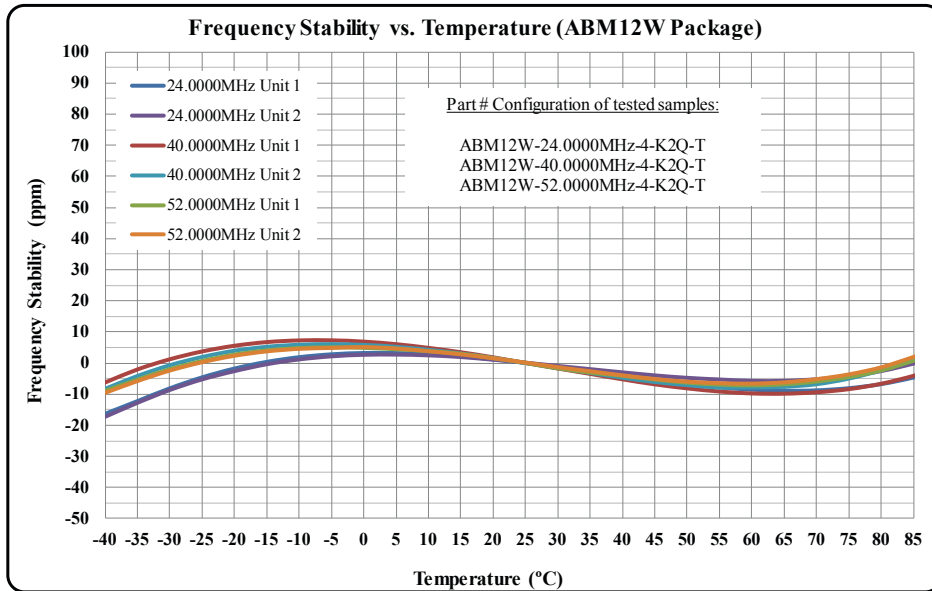

TYPICAL ESR (EQUIVALENT SERIES RESISTANCE) Vs. TEMPERATURE CHARACTERISTICS

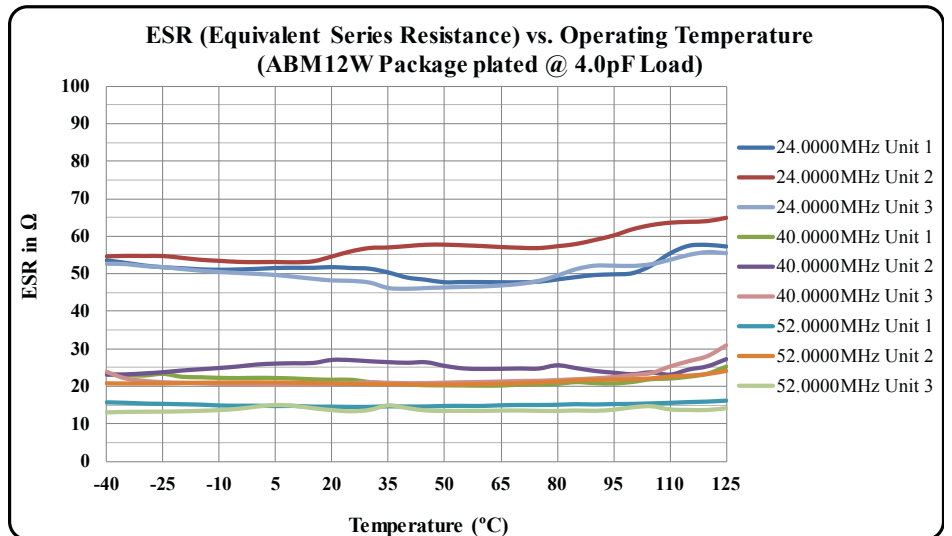
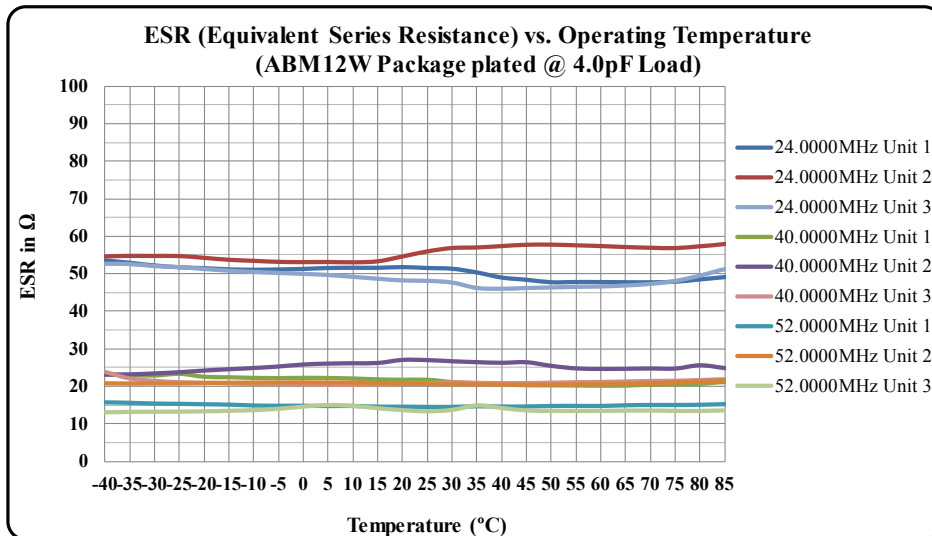

IoT OPTIMIZED LOW PROFILE QUARTZ CRYSTAL



ABM12W SERIES

1.6 x 1.2 x 0.4mm



RoHS/RoHS II Compliant

MSL = N/A: NOT APPLICABLE

TYPICAL FREQUENCY TOLERANCE DISTRIBUTION (AT 25°C ± 3°C)

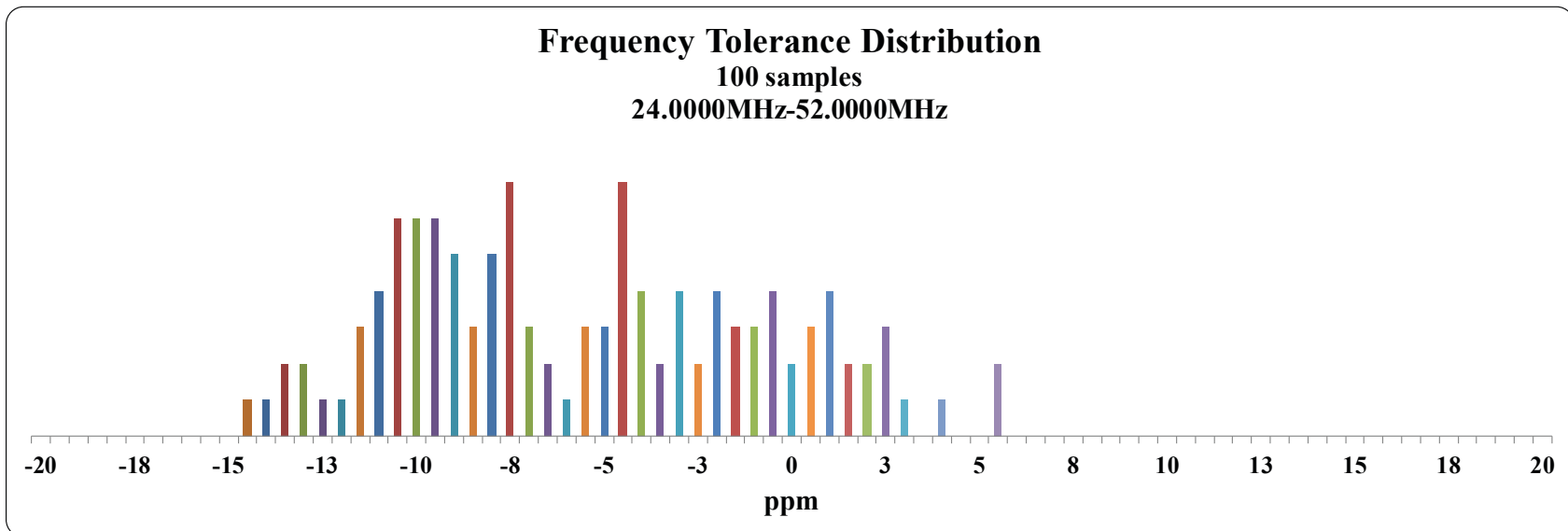

TYPICAL ESR DISTRIBUTION (AT 25°C ± 3°C)

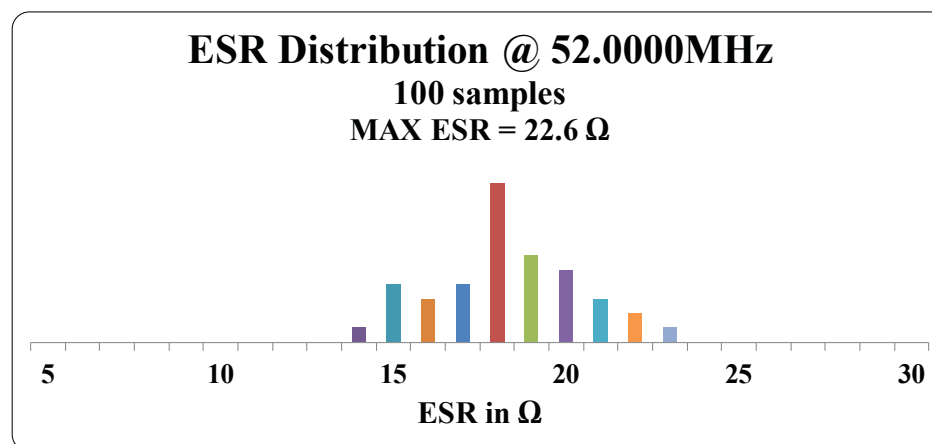
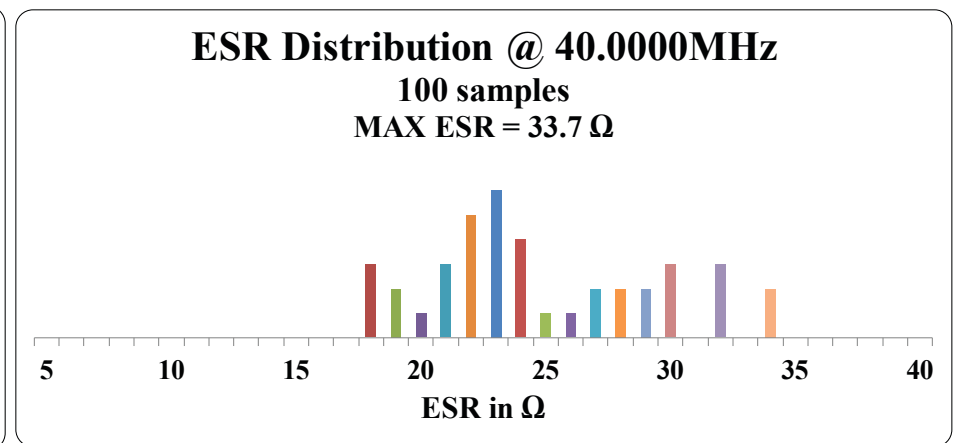
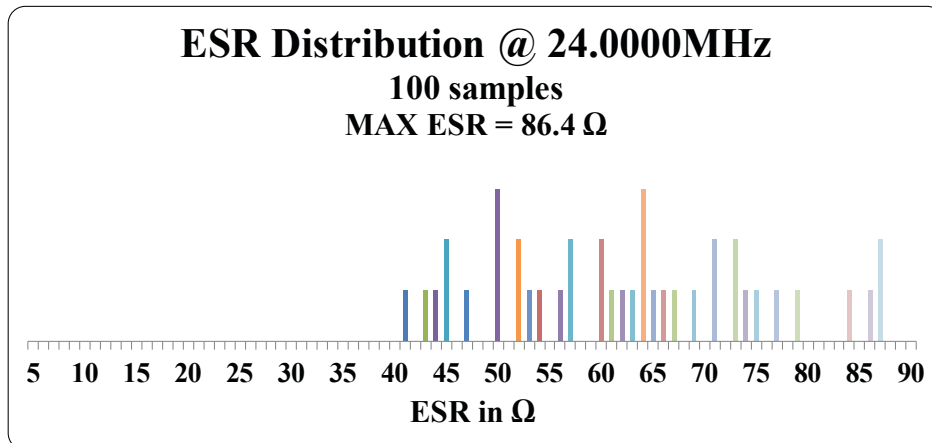

IoT OPTIMIZED LOW PROFILE QUARTZ CRYSTAL



ABM12W SERIES

1.6 x 1.2 x 0.4mm



RoHS/RoHS II Compliant

MSL = N/A: NOT APPLICABLE

SPICE MODELS (BASED ON TYPICAL VALUES AT 25°C ± 3°C)

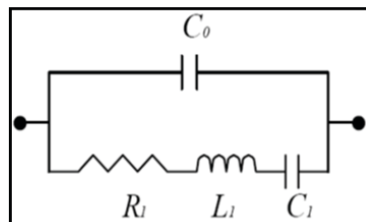

Frequency: 24.0000MHz Plating Load: 4pF				Frequency: 24.0000MHz Plating Load: 6pF			
C0	=	0.58	pF	C0	=	0.49	pF
R1	=	54.20	Ω	R1	=	67.91	Ω
L1	=	52.83	mH	L1	=	50.66	mH
C1	=	0.83	fF	C1	=	0.87	fF
Frequency: 40.0000MHz Plating Load: 4pF				Frequency: 40.0000MHz Plating Load: 6pF			
C0	=	0.65	pF	C0	=	0.63	pF
R1	=	27.21	Ω	R1	=	22.99	Ω
L1	=	10.55	mH	L1	=	10.47	mH
C1	=	1.50	fF	C1	=	1.51	fF
Frequency: 52.0000MHz Plating Load: 4pF				Frequency: 52.0000MHz Plating Load: 6pF			
C0	=	0.63	pF	C0	=	0.64	pF
R1	=	18.03	Ω	R1	=	18.27	Ω
L1	=	5.74	mH	L1	=	5.50	mH
C1	=	1.63	fF	C1	=	1.70	fF

MECHANICAL DIMENSIONS

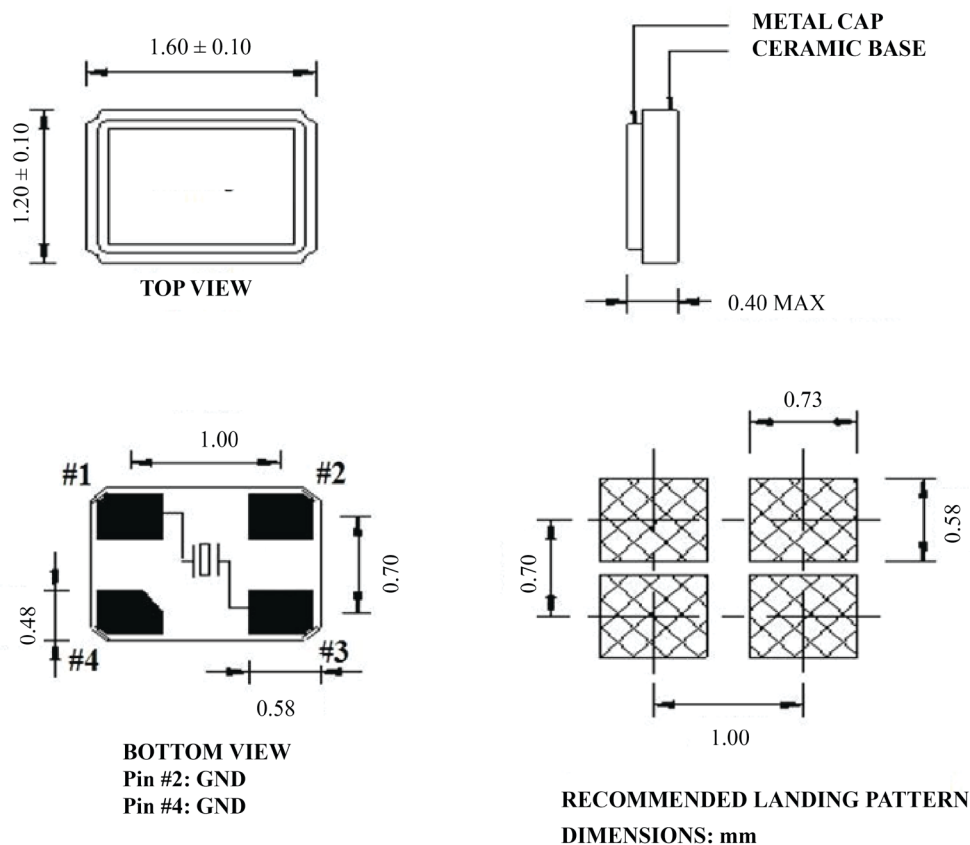

Note:

Due to material availability the Chamfer could be located on pin #1, 2 or 4. Be advised that the Chamfer location has no impact on the electrical performance of the device.

IoT OPTIMIZED LOW PROFILE QUARTZ CRYSTAL

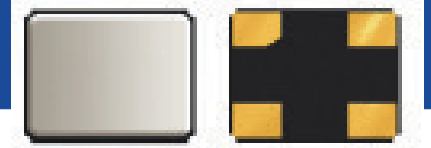

ABM12W SERIES

1.6 x 1.2 x 0.4mm



RoHS/RoHS II Compliant

MSL = N/A: NOT APPLICABLE

REFLOW PROFILE

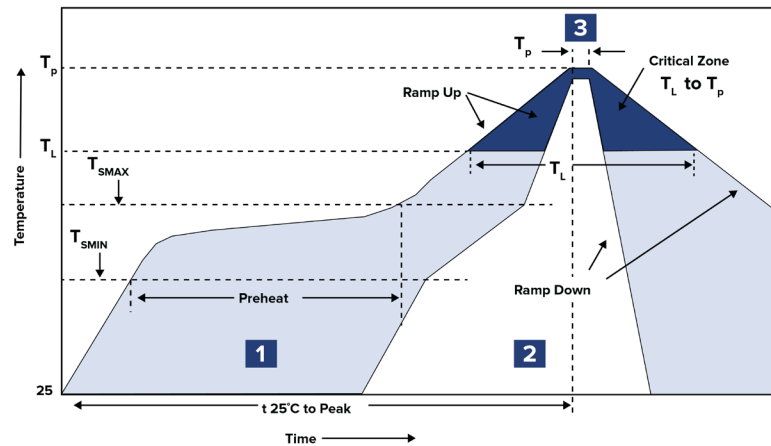

Zone	Description	Temperature	Time
1	Preheat	$T_{SMIN} \sim T_{SMAX}$ 150°C ~ 180°C	60 ~ 120 sec.
2	Reflow	T_L 217°C	45 ~ 90 sec.
3	Peak Heat	T_p 260°C MAX	10 sec.

PACKAGING

T3: Tape and reel (3,000 pcs/reel)

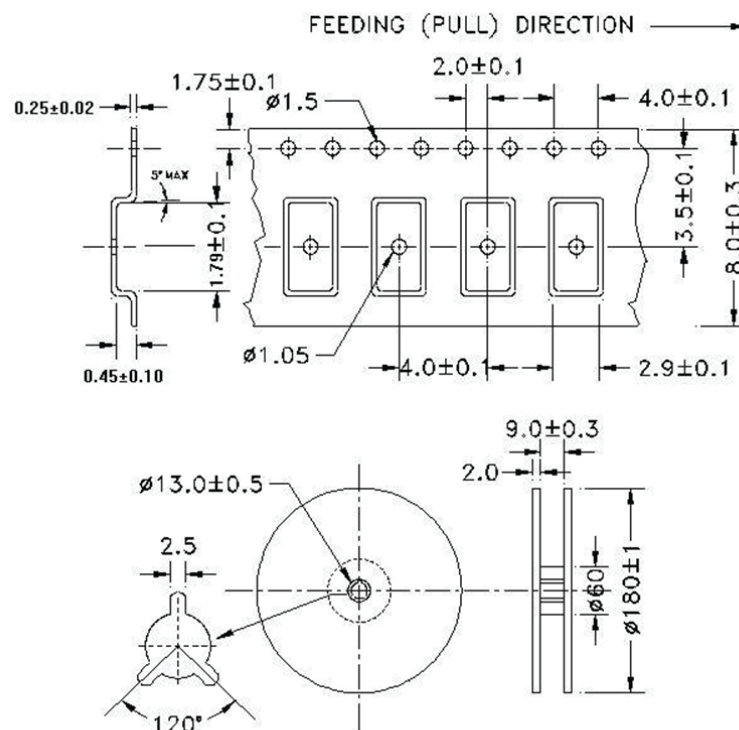

DIMENSIONS: mm