

## T3 / DS3 / E3 / STS-1 TRANSFORMERS

- DEVELOPED FOR USE IN T3, DS3, E3, AND STS-1 INTERFACES
- RETURN LOSS MEETS REQUIREMENTS OF G.703
- FAST RISE TIMES
- THROUGH-HOLE AND SURFACE MOUNT PACKAGES AVAILABLE
- 1500 Vrms ISOLATION AND 3000 Vrms REINFORCED INSULATION PER BAPT EN41003/EN60950 AND UL 1950 AVAILABLE
- SINGLE, DUALS, CUSTOMS AVAILABLE

### ELECTRICAL SPECIFICATIONS @ 25° C

Part Number	Turns Ratio (± 2%)	OCL Primary (μH MIN)	L <sub>L</sub> (μH MAX)	Bandwidth 75 Ω System (MHz TYP)	Isolation Voltage (V <sub>rms</sub> MIN)	Package/ Schematic	Primary Pins
XF04061-2B	1:1	40	.12	—	1500	XF-2B / C	2-6
XF03561-2B	1:2CT	35	.12	—	1500	XF-2B / E	2-6
XF05061-2B	1:4CT	150	.30	—	1500	XF-2B / E	2-6
XF0506-20	1:1.73CT	50	.10	.060 - 300	1500	XF-20 / A	4-6
XF04061-20	1:1	40	.10	.200 - 340	1500	XF-20 / B	4-6
XF04061-2S	1:1	40	.10	.200 - 340	1500	XF-2S / B	4-6
XF01962-20	1:2CT	19	.06	.250 - 500	1500	XF-2S / A	4-6
XF01962-2S	1:2CT	19	.06	.250 - 500	1500	XF-20 / A	4-6
XF0406TM	1:1	40	.10	—	3000	XF-TM / D	1-5
XF0196TM	1:2CT	19	.06	—	3000	XF-TM / C	1-5
XF04061-2SA	1:1	40	.20	—	3000	XF-2S / B	4-6
XF01962-20A	1:2CT	19	.20	—	3000	XF-2S / A	4-6

### SCHEMATICS:

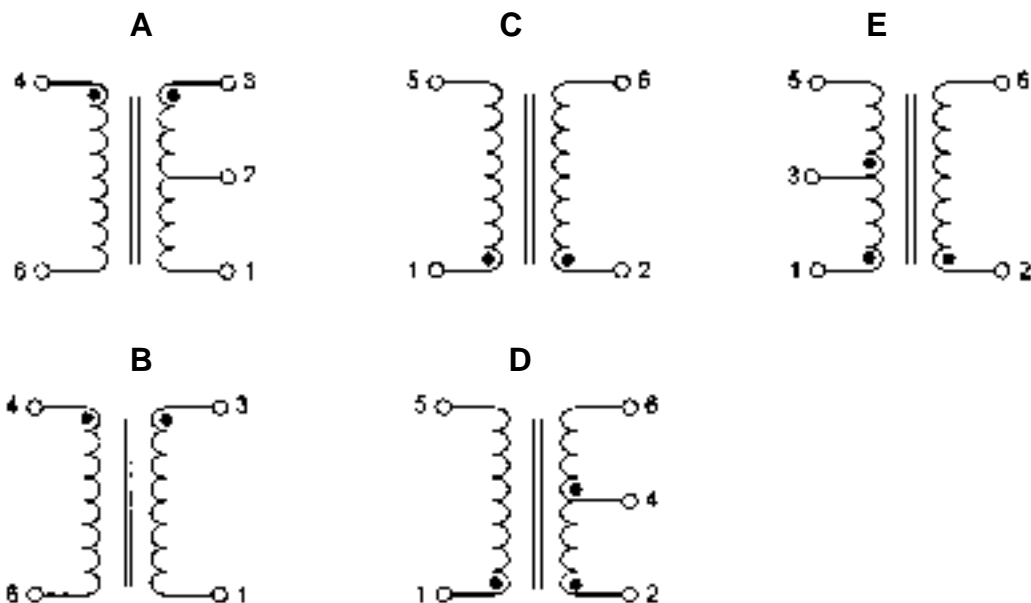

## T3 / DS3 / E3 / STS-1 TRANSFORMERS

Dimensions: (  $\frac{\text{Inches}}{\text{mm}}$  )

### XF-2S

#### SUGGESTED PAD LAYOUT

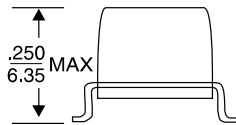
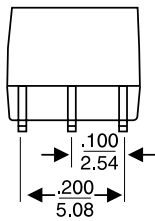
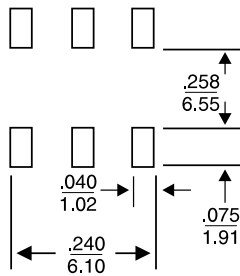
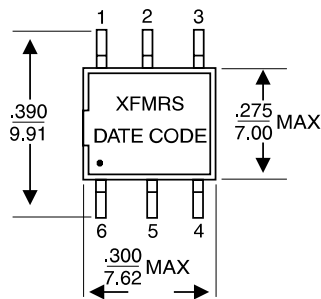

### XF-20

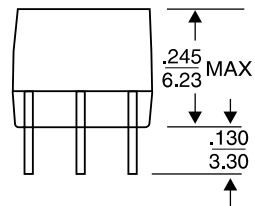
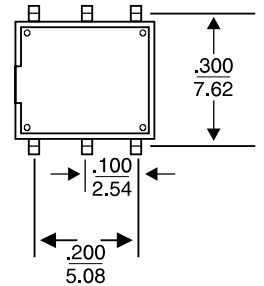
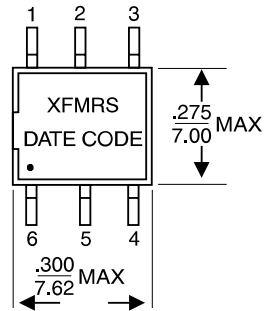

Leads are:  
.010 (0.25) X .020 (0.51)  
solderable.

### XF-2B

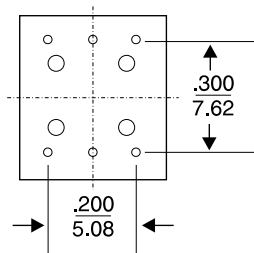
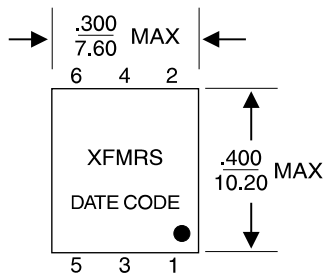

Leads are 22 AWG solderable.

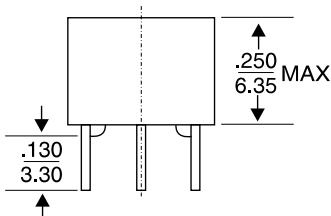

### XF-TM

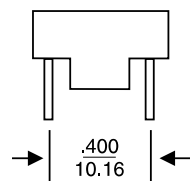
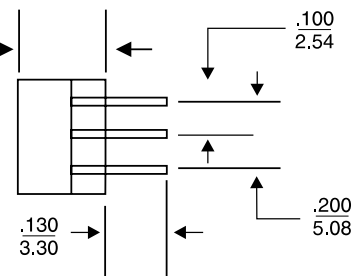
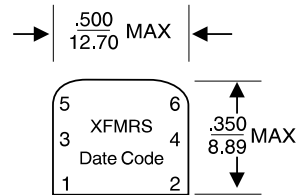

Notes: Leads are 24 AWG solderable.  
Unused pins not provided.