



APPLICATIONS

Wireless Network
Telecom/Datacom
Industry Control System
Measurement
Semiconductor Equipment

FEATURES

- 30 WATTS OUTPUT POWER
- OUTPUT CURRENT UP TO 8.5A
- STANDARD 2.00 X 1.00 X 0.40 INCH
- HIGH EFFICIENCY UP TO 91%
- 2:1 WIDE INPUT VOLTAGE RANGE
- SIX-SIDED CONTINUOUS SHIELD
- FIXED SWITCHING FREQUENCY
- CE MARK MEETS 2006/95/EC, 93/68/EEC AND 89/336 EEC
- DESIGN MEETS UL60950-1, EN60950-1 AND IEC60950-1
- ISO9001 CERTIFIED MANUFACTURING FACILITIES
- COMPLIANT TO RoHS EU DIRECTIVE 2002/95/EC

OPTIONS

Negative logic Remote On/Off

DESCRIPTION

The FED30 series offer 30 watts of output power from a 2 x 1 x 0.4 inch package. FED30 series have 2:1 wide input voltage of 9-18 and 18-36 and 36-75VDC. The FED30 series have features 1600VDC of isolation, short circuit protection, over-current protection, over-voltage protection, over-temperature protection and six sided shielding.

TECHNICAL SPECIFICATION

All specifications are typical at nominal input, full load and 25°C otherwise noted

OUTPUT SPECIFICATIONS			
Output power			30 Watts max.
Voltage accuracy	Full load and nominal Vin		±1%
Voltage adjustability	Single output		± 10%
Minimum load			0%
Line regulation	LL to HL at Full Load		± 0.2%
Load regulation	No load to Full load	Single Dual	± 0.5% ± 1%
Cross regulation (Dual)	Asymmetrical load 25% / 100% FL		± 5%
Ripple and noise	20MHz bandwidth (Measured with a 1uF/50V MLCC)	1.5-5.1Vo 12-15Vo	100mVp-p 150mVp-p
Temperature coefficient			±0.02% / °C, max.
Transient response recovery time	25% load step change		250µS
Over voltage protection Zener diode clamp	1.5V	Output	2.0V
	2.5V	Output	3.3V
	3.3V	Output	3.9V
	5.0V & 5.1V & ±5V	Output	6.2V
	12V & ±12V 15V & ±15V	Output Output	15V 18V
Over load protection	% of FL at nominal input		150%, typ.
Short circuit protection			Hiccup, automatics recovery
GENERAL SPECIFICATIONS			
Efficiency			See table
Isolation voltage	Input to Output Input (Output) to Case		1600VDC, min. 1600VDC, min.
Case grounding			Connect case to -Vin with decoupling Y Cap
Isolation resistance			10 ⁹ ohms, min.
Isolation capacitance			1500pF, max.
Switching frequency			430KHz, typ.
Design meets safety standard			IEC60950-1, UL60950-1, EN60950-1
Case material			Nickel-coated copper
Base material			FR4 PCB
Potting material			Epoxy (UL94-V0)
Dimensions			2.00 X 1.00 X 0.40 Inch (50.8 X 25.4 X 10.2 mm)
Weight			30.5g(1.07oz)
MTBF (Note 1)	BELLCORE-TR-NWT-000332		3.173 x 10 ⁵ hrs.
	MIL-HDBK-217F		5.548 x 10 ⁵ hrs.

INPUT SPECIFICATIONS			
Input voltage range	12V nominal input		9 – 18VDC
	24V nominal input		18 – 36VDC
	48V nominal input		36 – 75VDC
Input filter			Pi type
Input surge voltage 100mS max	12V input		25VDC
	24V input		50VDC
	48V input		100VDC
Input reflected ripple current	Nominal Vin and full load		20mAp-p
Start up time	Nominal Vin and constant resistive load	Power up	30mS, typ.
		Remote ON/OFF	30mS, typ.
Start-up voltage	12V input		9VDC
	24V input		18VDC
	48V input		36VDC
Shutdown voltage	12V input		8VDC
	24V input		16VDC
	48V input		32VDC
Remote ON/OFF (Note 6) (Positive logic)(Standard)	DC-DC ON		Open or 3V < Vr < 12V
	DC-DC OFF		Short or 0V < Vr < 1.2V
	DC-DC ON		Short or 0V < Vr < 1.2V
		DC-DC OFF	
Input current of Remote control pin	Nominal Vin		-0.5mA ~ +0.5mA
Remote off state input current	Nominal Vin		3mA
ENVIRONMENTAL SPECIFICATIONS			
Operating ambient temperature			-40°C to +50°C (without derating)
			+50°C to +85°C (with derating)
Maximum case temperature			105°C
Storage temperature range			-55°C to +125°C
Over temperature protection			115°C, typ.
Thermal impedance (Note 7)	Nature convection with heat-sink	Nature convection	12°C/Watt
			10°C/Watt
Thermal shock			MIL-STD-810F
Vibration			MIL-STD-810F
Relative humidity			5% to 95% RH
EMC CHARACTERISTICS			
EMI (Note 8)	EN55022		Class A
ESD	EN61000-4-2	Air Contact	± 8KV ± 6KV
			Perf. Criteria A
Radiated immunity	EN61000-4-3		10 V/m Perf. Criteria A
Fast transient (Note 9)	EN61000-4-4		± 2KV Perf. Criteria A
Surge (Note 9)	EN61000-4-5		± 1KV Perf. Criteria A
Conducted immunity	EN61000-4-6		10 Vr.m.s Perf. Criteria A





Model Number	Input Range	Output Voltage	Output Current		Output (4) Ripple & Noise	Input Current		Eff (4) (%)	Capacitor(5) Load max
			Min. Load	Max. Load		No load(3)	Full Load(2)		
FED30-12S1P5	9 – 18 VDC	1.5 VDC	0mA	8500mA	100mVp-p	70mA	1416mA	79	20000μF
FED30-12S2P5	9 – 18 VDC	2.5 VDC	0mA	8000mA	100mVp-p	100mA	2083mA	84	20000μF
FED30-12S3P3	9 – 18 VDC	3.3 VDC	0mA	8000mA	100mVp-p	90mA	2716mA	85	20000μF
FED30-12S05	9 – 18 VDC	5.0 VDC	0mA	6000mA	100mVp-p	130mA	3012mA	87	14400μF
FED30-12S5P1	9 – 18 VDC	5.1 VDC	0mA	6000mA	100mVp-p	130mA	3072mA	87	14400μF
FED30-12S12	9 – 18 VDC	12 VDC	0mA	2500mA	150mVp-p	90mA	2941mA	89	3000μF
FED30-12S15	9 – 18 VDC	15 VDC	0mA	2000mA	150mVp-p	80mA	2941mA	89	2000μF
FED30-12D05	9 – 18 VDC	±5VDC	0mA	±3000mA	100mVp-p	90mA	3012mA	87	± 3000μF
FED30-12D12	9 – 18 VDC	±12VDC	0mA	±1250mA	150mVp-p	50mA	3012mA	87	± 2000μF
FED30-12D15	9 – 18 VDC	±15VDC	0mA	±1000mA	150mVp-p	40mA	3012mA	87	± 1300μF
FED30-24S1P5	18 – 36 VDC	1.5 VDC	0mA	8500mA	100mVp-p	50mA	700mA	80	20000μF
FED30-24S2P5	18 – 36 VDC	2.5 VDC	0mA	8000mA	100mVp-p	50mA	1028mA	85	20000μF
FED30-24S3P3	18 – 36 VDC	3.3 VDC	0mA	8000mA	100mVp-p	50mA	1325mA	87	20000μF
FED30-24S05	18 – 36 VDC	5.0 VDC	0mA	6000mA	100mVp-p	75mA	1453mA	90	14400μF
FED30-24S5P1	18 – 36 VDC	5.1 VDC	0mA	6000mA	100mVp-p	75mA	1482mA	90	14400μF
FED30-24S12	18 – 36 VDC	12 VDC	0mA	2500mA	150mVp-p	40mA	1437mA	91	3000μF
FED30-24S15	18 – 36 VDC	15 VDC	0mA	2000mA	150mVp-p	30mA	1437mA	91	2000μF
FED30-24D05	18 – 36 VDC	±5VDC	0mA	±3000mA	100mVp-p	70mA	1453mA	90	± 3000μF
FED30-24D12	18 – 36 VDC	±12VDC	0mA	±1250mA	150mVp-p	30mA	1471mA	89	± 2000μF
FED30-24D15	18 – 36 VDC	±15VDC	0mA	±1000mA	150mVp-p	30mA	1453mA	90	± 1300μF
FED30-48S1P5	36 – 75 VDC	1.5 VDC	0mA	8500mA	100mVp-p	45mA	350mA	80	20000μF
FED30-48S2P5	36 – 75 VDC	2.5 VDC	0mA	8000mA	100mVp-p	45mA	514mA	85	20000μF
FED30-48S3P3	36 – 75 VDC	3.3 VDC	0mA	8000mA	100mVp-p	30mA	663mA	87	20000μF
FED30-48S05	36 – 75 VDC	5.0 VDC	0mA	6000mA	100mVp-p	45mA	727mA	90	14400μF
FED30-48S5P1	36 – 75 VDC	5.1 VDC	0mA	6000mA	100mVp-p	45mA	750mA	89	14400μF
FED30-48S12	36 – 75 VDC	12 VDC	0mA	2500mA	150mVp-p	40mA	718mA	91	3000μF
FED30-48S15	36 – 75 VDC	15 VDC	0mA	2000mA	150mVp-p	40mA	718mA	91	2000μF
FED30-48D05	36 – 75 VDC	±5VDC	0mA	±3000mA	100mVp-p	35mA	727mA	90	± 3000μF
FED30-48D12	36 – 75 VDC	±12VDC	0mA	±1250mA	150mVp-p	30mA	744mA	88	± 2000μF
FED30-48D15	36 – 75 VDC	±15VDC	0mA	±1000mA	150mVp-p	20mA	735mA	89	± 1300μF

Note

- BELLCORE TR-NWT-000332. Case I: 50% Stress, Temperature at 40°C. (Ground fixed and controlled environment)
MIL-STD-217F Notice2 @Ta=25 °C, Full load (Ground, Benign, controlled environment)
- Maximum value at nominal input voltage.
- Typical value at nominal input voltage and no load.
- Typical value at nominal input voltage and full load.
- Test by minimum Vin and constant resistive load.
- The ON/OFF control pin voltage is referenced to -Input.
- Heat sink is optional and P/N: 7G-0020A-F.
- The FED30 series can meet EN55022 Class A with parallel an external capacitor to the input pins.
Recommend: 12Vin : 10μF/25V X7R 1812 MLCC; 24Vin : 4.7μF/50V X7R 1812 MLCC; 48Vin : 2.2μF/100V X7R 1812 MLCC .
- An external filter capacitor is required if the module has to meet EN61000-4-4, EN61000-4-5.
The filter capacitor Power Mate suggest: 12Vin & 24Vin : Nippon chemi-con KY series, 330μF/50V, ESR 55mΩ .
48Vin : Nippon chemi-con KY series, 220μF/100V, ESR 48mΩ

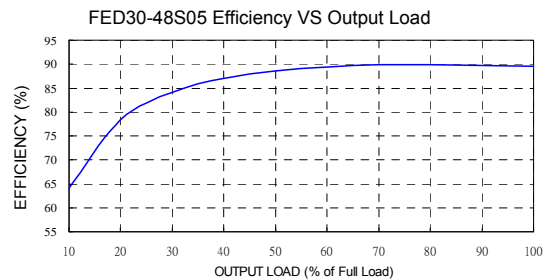
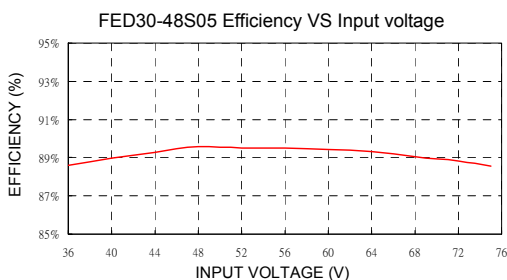
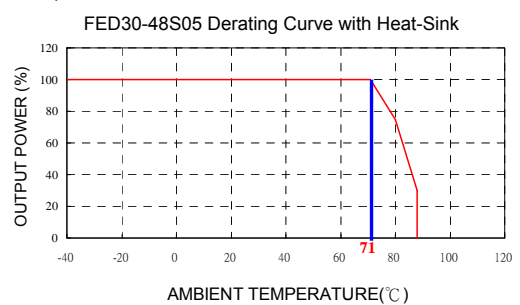
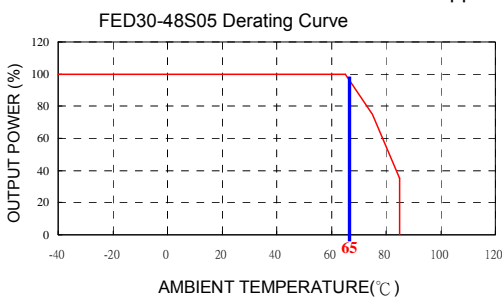

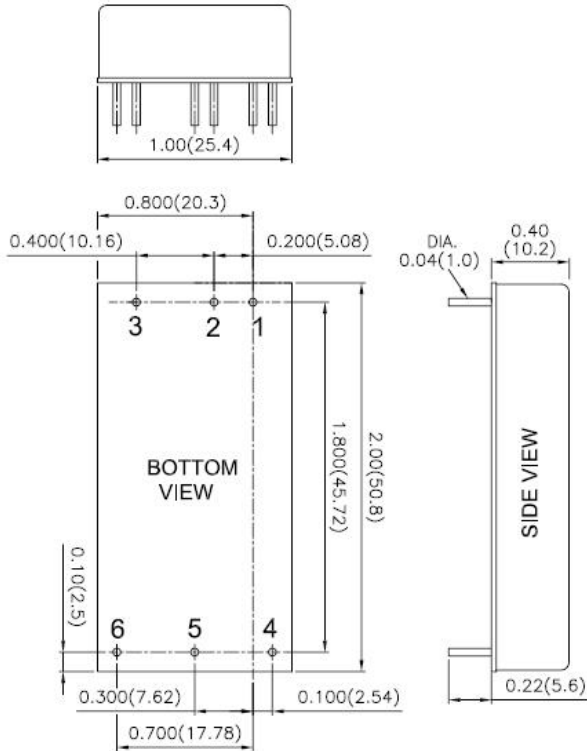

1. All dimensions in Inches (mm)
Tolerance: X.XX±0.02 (X.X±0.5)
X.XXX±0.01 (X.XX±0.25)
2. Pin pitch tolerance ±0.01(0.25)
3. Pin dimension tolerance ±0.004 (0.1)

PIN CONNECTION		
PIN	SINGLE	DUAL
1	+ INPUT	+ INPUT
2	- INPUT	- INPUT
3	CTRL	CTRL
4	+ OUTPUT	+ OUTPUT
5	- OUTPUT	COMMON
6	TRIM	- OUTPUT

EXTERNAL OUTPUT TRIMMING

Output can be externally trimmed by using the method shown below.

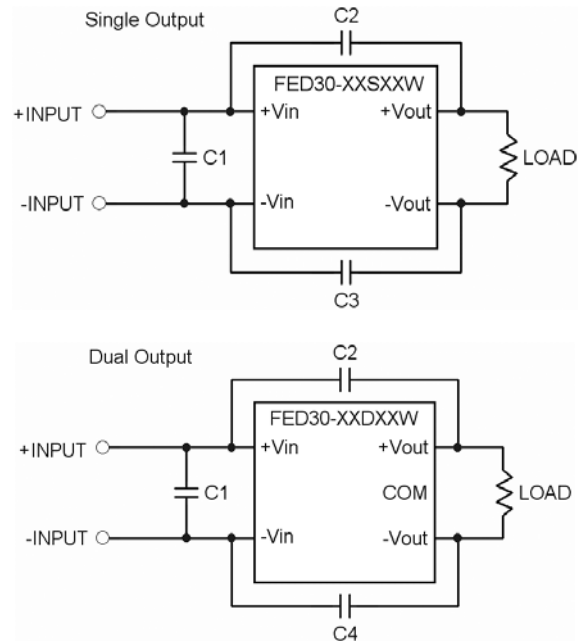
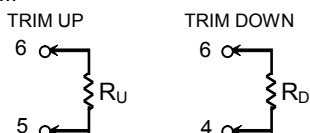

Recommended Filter for EN55022 Class A Compliance

The components used in the above figure, together with the manufacturers' part numbers for these components, are as follows:

Single Output	C1	C2 & C3
FED30-12S XX	10µF/25V 1812 MLCC	1000pF/2KV 1808 MLCC
FED30-24S XX	6.8µF/50V 1812 MLCC	1000pF/2KV 1808 MLCC
FED30-48S XX	2.2µF/100V 1812 MLCC	1000pF/2KV 1808 MLCC

Dual Output	C1	C2 & C4
FED30-12D XX	10µF/25V 1812 MLCC	1000pF/2KV 1808 MLCC
FED30-24D XX	6.8µF/50V 1812 MLCC	1000pF/2KV 1808 MLCC
FED30-48D XX	2.2µF/100V 1812 MLCC	1000pF/2KV 1808 MLCC

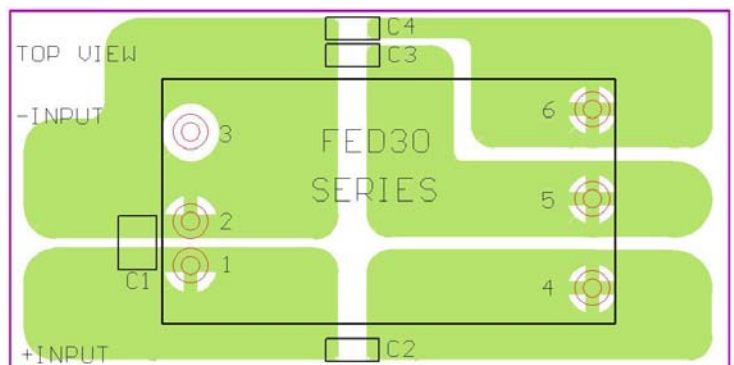

Recommended EN55022 Class A Filter Circuit Layout

