

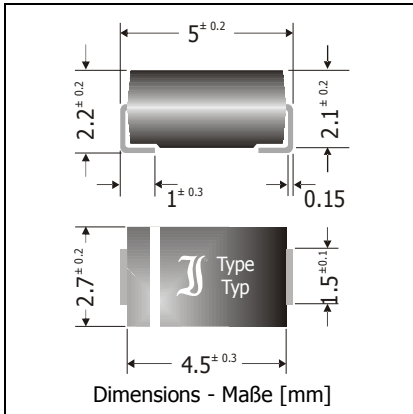

## Z1SMA1 ... Z1SMA100 (1 W)

### Surface mount Silicon-Zener Diodes (non-planar technology) Flächendiffundierte Si-Zener-Dioden für die Oberflächenmontage

Version 2014-07-11



Maximum power dissipation Maximale Verlustleistung	1 W
Nominal Z-voltage – Nominale Z-Spannung	1 ... 100 V
Plastic case Kunststoffgehäuse	~ SMA ~ DO-214AC
Weight approx. – Gewicht ca.	0.07 g
Plastic material has UL classification 94V-0 Gehäusematerial UL94V-0 klassifiziert	
Standard packaging taped and reeled Standard Lieferform gegurtet auf Rolle	

Standard Zener voltage tolerance is graded to the international E 24 (~5%) standard.  
Other voltage tolerances and higher Zener voltages on request.

Die Toleranz der Zener-Spannung ist in der Standard-Ausführung gestuft nach der internationalen Reihe E 24 (~5%). Andere Toleranzen oder höhere Arbeitsspannungen auf Anfrage.

#### Maximum ratings and Characteristics

#### Grenz- und Kennwerte

Power dissipation Verlustleistung	$T_A = 50^\circ\text{C}$	$P_{\text{tot}}$	1 W <sup>1)</sup>
Operating junction temperature – Sperrschichttemperatur Storage temperature – Lagerungstemperatur		$T_j$ $T_s$	-50...+150°C -50...+175°C
Thermal Resistance Junction – Ambient air Wärmewiderstand Sperrschicht – umgebende Luft		$R_{\text{thA}}$	<70 K/W <sup>1)</sup>
Thermal Resistance Junction – Terminal Wärmewiderstand Sperrschicht – Anschluss		$R_{\text{thT}}$	<30 K/W
Zener voltages see table on next page – Zener-Spannungen siehe Tabelle auf der nächsten Seite			

- 1 Mounted on P.C. board with 25 mm<sup>2</sup> copper pads at each terminal  
Montage auf Leiterplatte mit 25 mm<sup>2</sup> Kupferbelag (Löt-pad) an jedem Anschluss
- 2 Tested with pulses – Gemessen mit Impulsen
- 3 The Z1SMA1 is a diode operated in forward mode. Hence, the index of all parameters should be "F" instead of "Z".  
The cathode, indicated by a white band has to be connected to the negative pole.  
Die Z1SMA1 ist eine in Durchlass betriebene Si-Diode. Daher ist bei allen Kenn- und Grenzwerten der Index "F" anstatt "Z" zu setzen. Die mit weißem Balken gekennzeichnete Kathode ist mit dem Minuspol zu verbinden.

**Maximum ratings**
**Grenzwerte**

Type Typ	Zener voltage <sup>2)</sup> Zener-Spanng. <sup>2)</sup> I <sub>Z</sub> = 5 mA		Dynamic resistance Inhär. diff. Widerstand r <sub>Zj</sub> [Ω] at f = 1 kHz		Temp. Coeffic. of Z-voltage ...der Z-spanng. α <sub>VZ</sub> [10 <sup>-4</sup> /°C]	Reverse volt. Sperrspanng. I <sub>R</sub> = 1 μA	Z-current <sup>1)</sup> Z-Strom <sup>1)</sup> T <sub>A</sub> = 50°C
	V <sub>Zmin</sub> [V]	V <sub>Zmax</sub> [V]	I <sub>Z</sub> = 5 mA	I <sub>Z</sub> = 1 mA			
Z1SMA1 <sup>3)</sup>	0.71	0.82	6.5 (<8)	–	–26...–23	–	500
Z1SMA5.6	5.2	6.0	10 (<40)	< 500	–7...–3	> 0.5 / 3 μA	167
Z1SMA6.2	5.8	6.6	4.8 (<11)	< 300	–6...–1	> 1.5	152
Z1SMA6.8	6.4	7.2	4.5 (<10)	< 300	–5...+2	> 2	139
Z1SMA7.5	7.0	7.9	4.0 (<8)	< 100	–3...+4	> 2	127
Z1SMA8.2	7.7	8.7	4.5 (<10)	< 50	–2...+6	> 3.5	115
Z1SMA9.1	8.5	9.6	4.8 (<11)	< 50	–1...+7	> 3.5	104
Z1SMA10	9.4	10.6	5.2 (<15)	< 70	+2...+7	> 5	94
Z1SMA11	10.4	11.6	6 (<20)	< 70	+3...+7	> 5	86
Z1SMA12	11.4	12.7	7 (<20)	< 90	+4...+7	> 7	79
Z1SMA13	12.4	14.1	9 (<25)	< 110	+5...+8	> 7	71
Z1SMA15	13.8	15.6	11 (<30)	< 110	+5...+8	> 10	64
Z1SMA16	15.3	17.1	13 (<40)	< 170	+5...+9	> 10	58
Z1SMA18	16.8	19.1	18 (<50)	< 170	+6...+9	> 10	52
Z1SMA20	18.8	21.2	20 (<50)	< 220	+7...+9	> 15	47
Z1SMA22	20.8	23.3	25 (<55)	< 220	+7...+9	> 17	43
Z1SMA24	22.8	25.6	28 (<80)	< 220	+7...+9.5	> 18	39
Z1SMA27	25.1	28.9	30 (<80)	< 250	+8...+9.5	> 20	35
Z1SMA30	28	32	35 (<80)	< 250	+8...+9.5	> 22.5	31
Z1SMA33	31	35	40 (<80)	< 250	+8...+10	> 25	29
Z1SMA36	34	38	40 (<90)	< 300	+8...+10	> 27	26
Z1SMA39	37	41	50 (<90)	< 500	+8...+10	> 29	24
Z1SMA43	40	46	60 (<100)	< 700	+8...+10	> 32	22
Z1SMA47	44	50	70 (<100)	< 750	+8...+10	> 35	20
Z1SMA51	48	54	70 (<100)	< 750	+8...+10	> 38	19
Z1SMA56	52	60	70 (<100)	< 750	+9...+11	> 42	17
Z1SMA62	58	66	80 (<110)	< 750	+9...+11	> 47	15
Z1SMA68	64	72	90 (<140)	< 750	+9...+12	> 51	14
Z1SMA75	70	79	95 (<150)	< 750	+9...+12	> 56	13
Z1SMA82	77	88	100 (<170)	< 750	+9...+12	> 62	11
Z1SMA91	85	96	130 (<200)	< 800	+10...+12	> 68	10
Z1SMA100	94	106	200 (<300)	< 800	+10...+12	> 75	9

1 Notes see previous page – Fußnoten siehe vorhergehende Seite

Z1SMA1 ... Z1SMA100 (1 W)

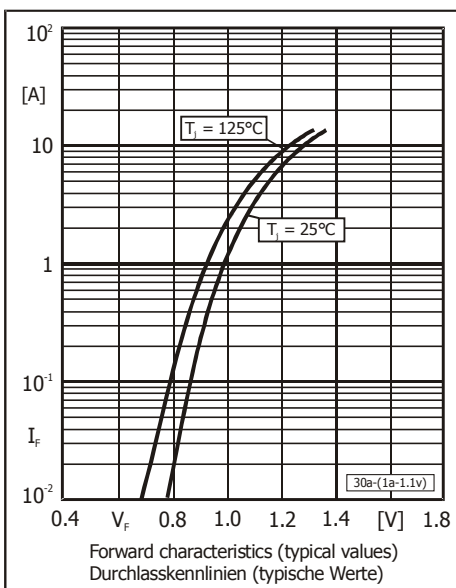
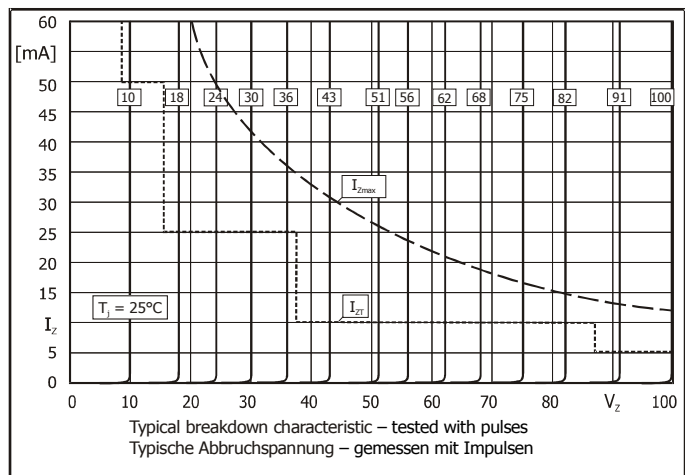
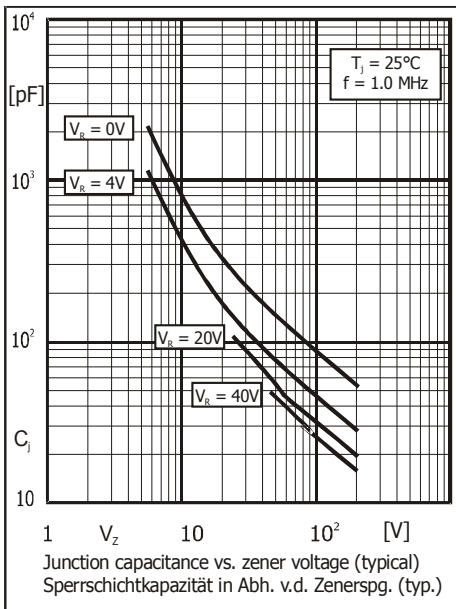
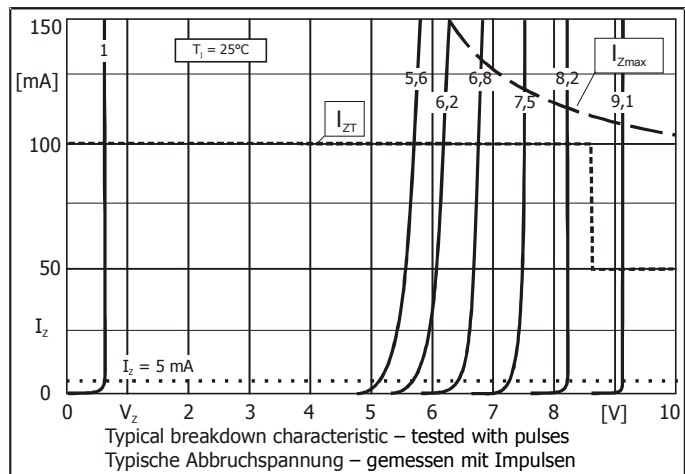
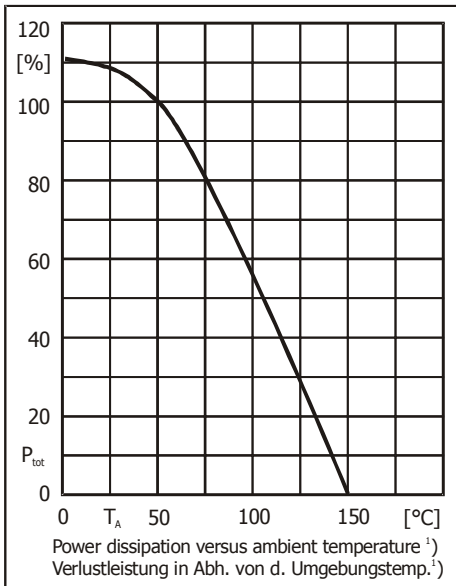

1 Mounted on P.C. board with 25 mm<sup>2</sup> copper pads at each terminal  
Montage auf Leiterplatte mit 25 mm<sup>2</sup> Kupferbelag (Löt-pad) an jedem Anschluss