

# Amphenol

MS & 97B - Series  
ACR11 0601

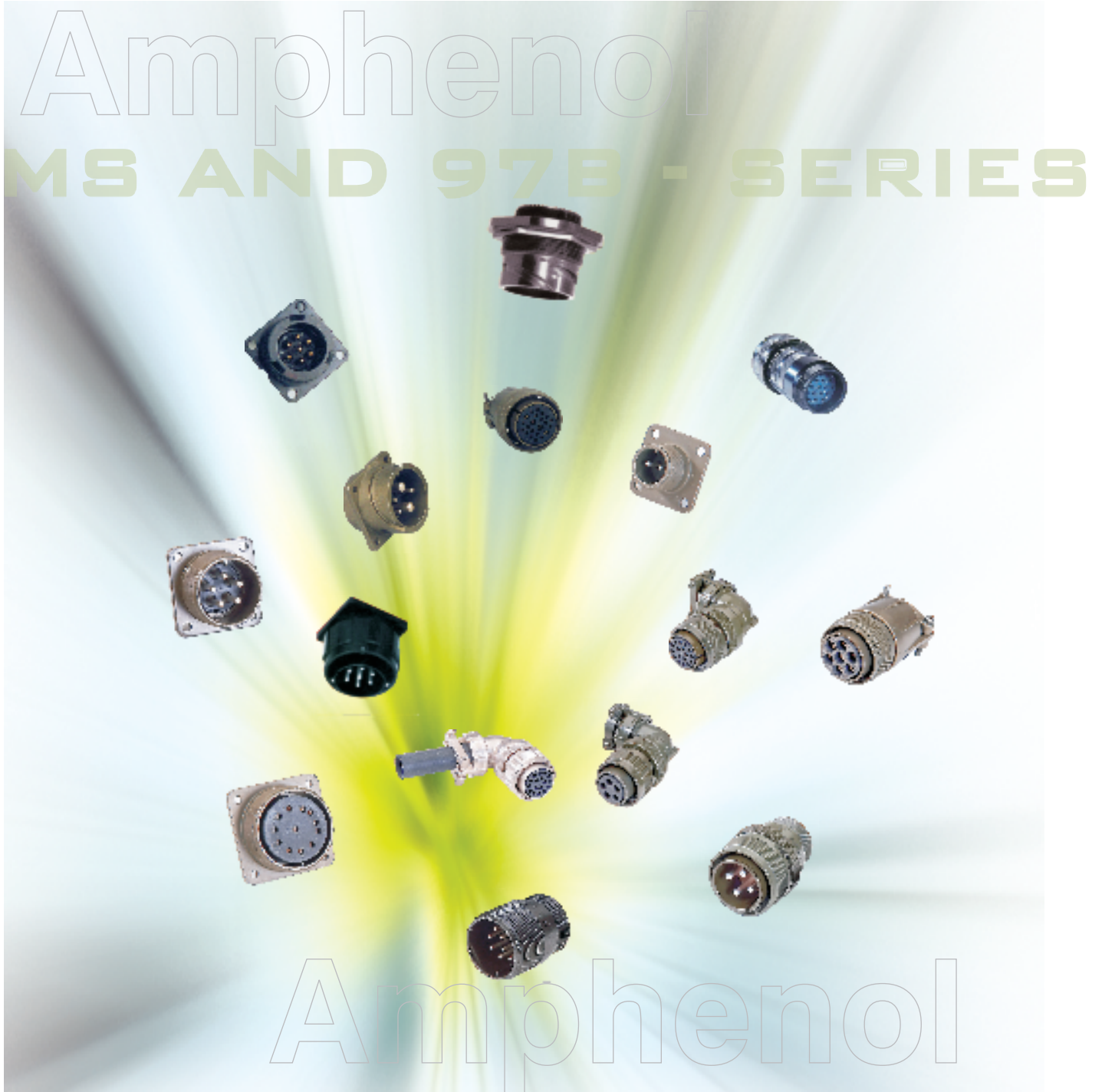

---

**Amphenol**



## Introduction

Amphenol MS and 97B series are two series of thread & Bayonet-coupled connectors designed to meet the operating requirements of **MIL-C-5015**. Available in a variety of styles and classes, these connectors are primarily used in a range of military and industrial applications where specific degrees of environmental protection are required.

Although MS series have identical insert arrangements and other similar component parts, the two series differ in that Amphenol MS series of connectors are also qualified to meet the operating requirements of Defence Standard Joint Services Specification **JSS50812**, issued by the Electronics Components Standardization Organisation (LCSO).

Amphenol 97B connectors feature a quick mating bayonet coupling with an audible full mating feature. This series uses the same **MIL-C-5015** insert patterns and are used in high shock and vibration environments encountered in commercial, geophysical, aerospace, ground support and shipboard applications.

### Page Contents

Introduction	1
Connector styles	2-3
General description	4
Electrical data	5
Insert orientations	6
Insert arrangements	7-18
Shell types	19-25
Back accessories	26-29
Other accessories	30-33
MS/97B Series	34
Ordering MS/97B series connectors	35

Connector Styles - MS

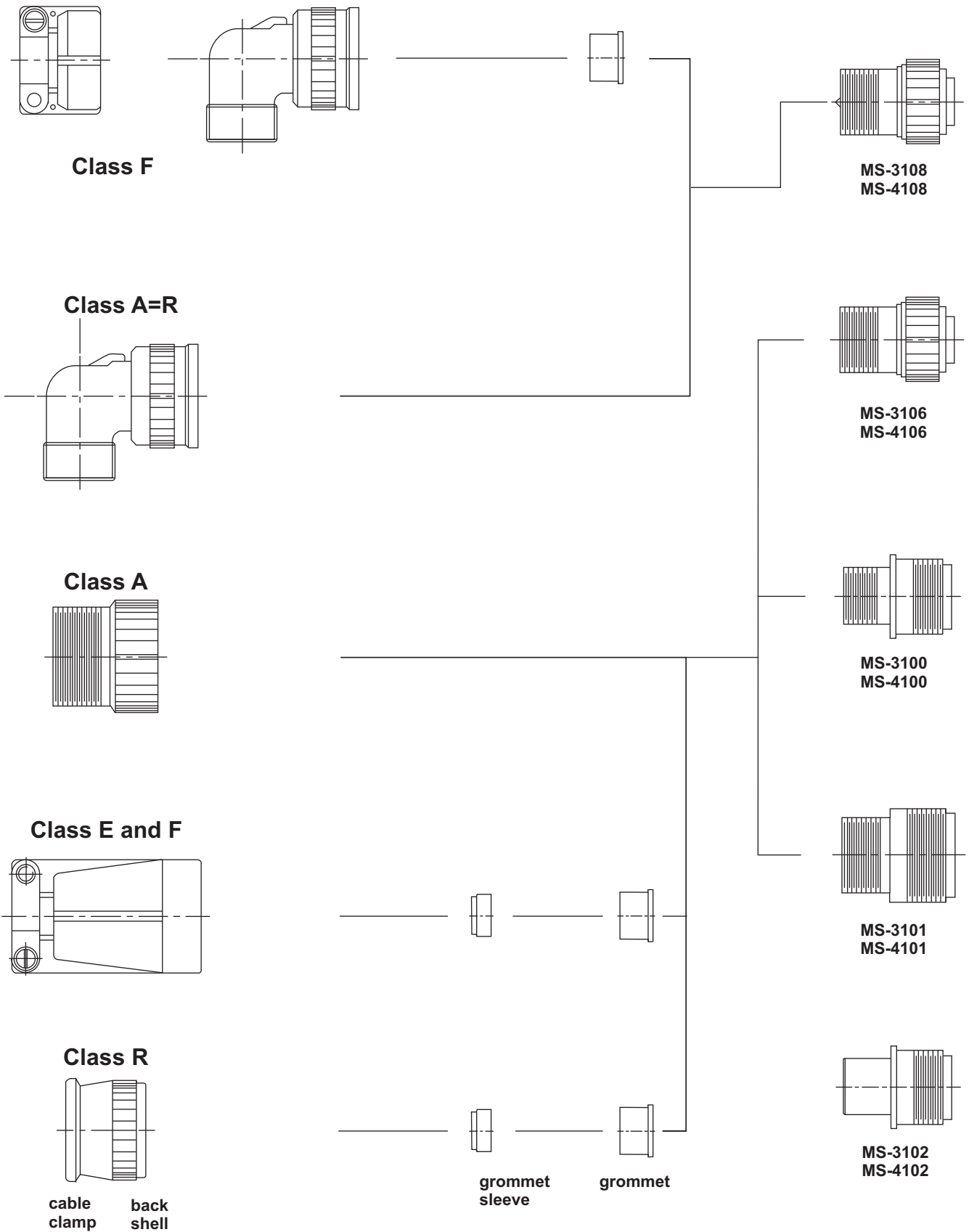

Connector Styles - 97B

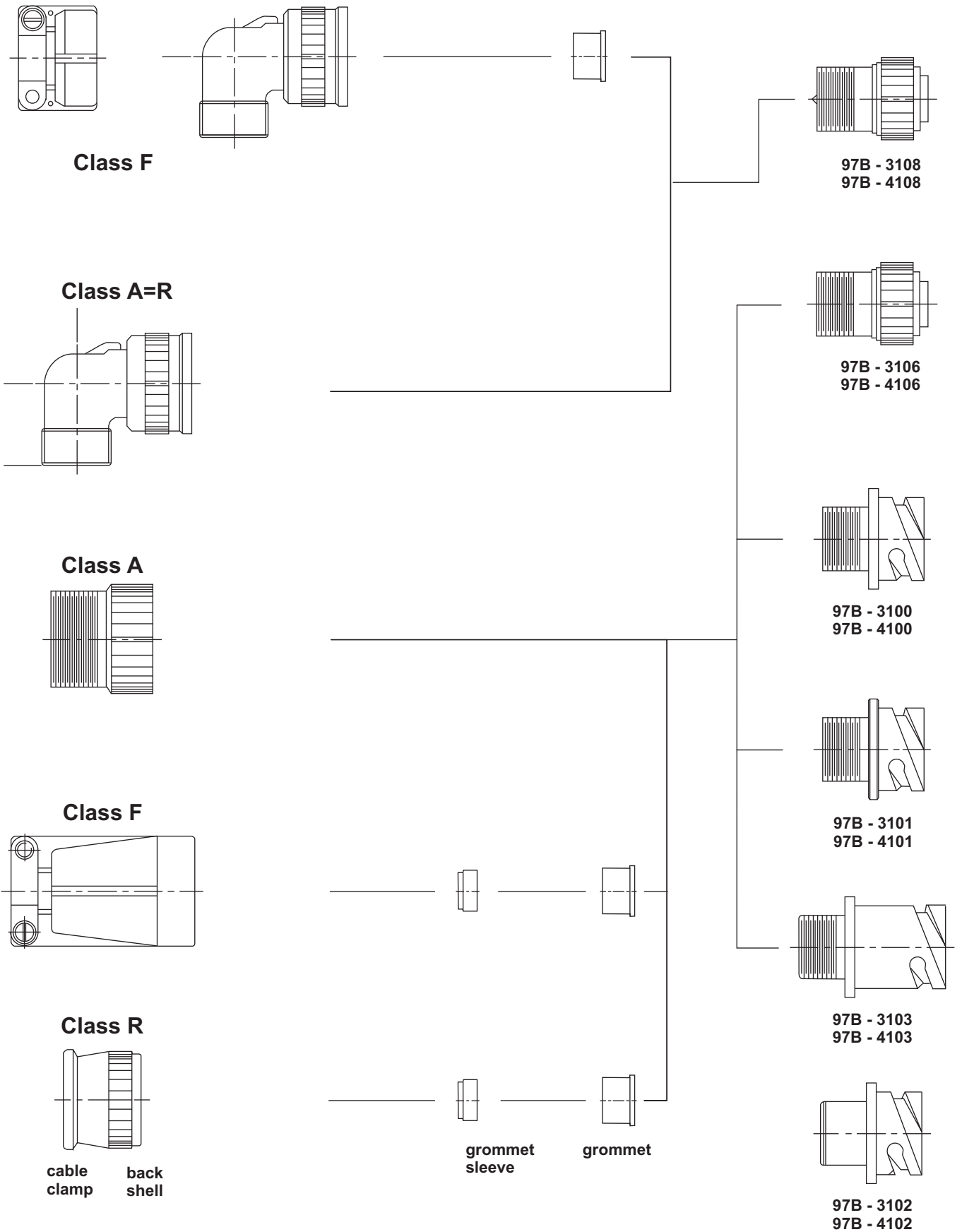

## General Description

These electrical connectors are designated MS because the interchangeability and operating characteristics are determined by U.S. Military Specifications. These specifications are revised from time to time to incorporate performance requirements dictated by design advances and more stringent requirements of allied equipment. The several designations of MS and 97B connectors meet different requirements of MIL-C-5015. These designations and general descriptions are as follows :

### Shell

Shell constructions include solid back shell (A) and environmental resistant (E, F & R). Environmental resistant connectors provide a moisture barrier and assure a positive seal. Shell styles consist of wall type receptacles (3100), cable receptacles (3101), box receptacles (3102), straight plugs (3106) and angle plugs (3108). Shell hardware is manufactured from aluminium alloy and cadmium plated with olive drab chromate finish. This finish has excellent conductivity; it is non-reflecting and corrosion resistant. Black anodised finish and cadmium-free zinc plating with olive drab chromate finish are also available. For details, contact factory.

### Contacts

Pin and socket contacts are of brass and generally silver plated. Gold plating is also available. For details contact factory. These contacts are available for solder or crimp termination. Special arrangements of contacts for pre-mating and pre-earth are also available.

### Inserts and grommet

Synthetic inserts and grommet manufactured according to MIL-R-3065, offer high dielectric strength and are resistant to oils, gasoline and low temperature. DAP is dimensionally stable, has high arc resistance and high insulation resistance under both humidity and thermal stress.

### General description

Plugs are available in A, F and R types. Receptacles are available in A, E, F and R types.

### A Solid back shell

Intended for general service usage to provide convenient means of connecting and disconnecting electrical circuits in industrial and military applications.

### Environmental resisting

Intended for use where the connector will be subject to heavy condensation and rapid changes in temperature or pressure and/or where the connector is subjected to high vibratory conditions.

**E** Environmental resisting with grommet seal and strain relief backshell except for 3102 type.

**F** Environmental resisting with grommet seal, strain relief backshell and front gasket seal for plug type.

**R** Environmental resisting with grommet seal, shorter and lightweight.

### Features for 97B reverse bayonet coupling connectors with Mil-C-5015 insert patterns:

- Quick positive coupling
- Audible and tactile indication of full coupling
- Waterproof
- No lockwiring required
- High shock and vibration capabilities
- Insert available in Neoprene material (alternate inserts materials available upon request)
- Operating temperature range with Neoprene inserts: -55°C to +125°C
- Available in both crimp and solder terminations
- Contacts available in gold and silver plating
- Numerous finishes available
- Zinc alloy plating (cadmium free) available
- Rugged construction; aluminum or stainless steel components
- Intermateable with existing VG95234 connectors
- 500 couplings minimum

## Electrical Data

### Dielectric strength

Service rating	Test Voltage Vac rms
Inst.	1000V
A	2000V
D	2800V
E	3500V
B	4500V
C	7000V

### Contact rating

Contact Size	Rated Current	Contact Resistance miliohms
16	13A	3.46
12	23A	1.83
8	46A	0.52
4	80A	0.26
0	150A	0.14

### Service rating

Service rating	Operating Voltage DC at Sea Level	Operating Voltage AC at Sea Level
Inst.	250V	200V
A	700V	500V
D	1250V	900V
E	1750V	1250V
B	2450V	1750V
C	4200V	3000V

## Insert Orientations

To avoid cross-plugging problems in applications requiring the use of more than one connector of the same size and arrangement, alternate insert rotations are available as indicated in the accompanying chart.

As shown in the diagram below, the front face of the pin insert is rotated within the shell in a clockwise direction from the normal shell key. The socket insert would be rotated counterclockwise the same number of degrees with respect to the normal shell key.

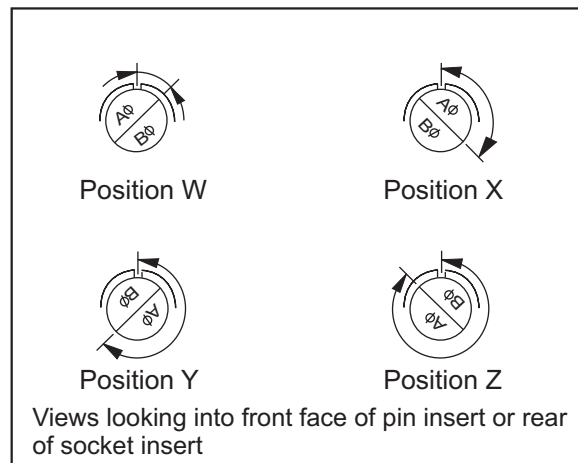

The following insert arrangements have the same alternate insert rotations for W, X, Y and Z which are as below :

Degree			
W	X	Y	Z
80	110	250	280

16-7	20-16	22-18	24-4	24-21	28-15	36-1
18-5	20-20	22-19	24-5	24-28	28-16	36-7
18-9	20-22	22-21	24-6	28-1	28-17	36-8
18-13	22-3	22-24	24-7	28-4	28-19	36-13
18-14	22-6	22-25	24-12	28-8	28-20	
20-7	22-12	22-29	24-14	28-9	28-21	
20-8	22-14	22-33	24-16	28-10	32-1	
20-9	22-15	22-34	24-17	28-11	32-3	
20-12	22-16	24-1	24-20	28-14	32-4	
20-14	22-17	24-3				

Insert Arrangement	Degrees			
	W	X	Y	Z
12S-3	70	145	215	290
14S-2	-	120	240	-
14S-5	-	110	-	-
14S-7	90	180	270	-
14S-9	70	145	215	290
16-9	35	110	250	325
16-10	90	180	270	-
16-11	35	110	250	325
16-13	35	110	250	325
16S-1	80	-	-	280
16S-4	35	110	250	325
16S-5	70	145	215	290
16S-6	90	180	270	-
16S-8	-	170	265	-
18-1	70	145	215	290
18-3	35	110	250	325
18-4	35	110	250	325
18-8	70	-	-	290
18-10	-	120	240	-
18-11	-	170	265	-
18-12	80	-	-	280
18-15	-	120	240	-
18-20	90	180	270	-
18-22	70	145	215	290
18-29	90	180	270	-
20-3	70	145	215	290
20-4	45	110	250	-
20-5	35	110	250	325

Insert Arrangement	Degrees			
	W	X	Y	Z
20-6	70	145	215	290
20-15	80	-	-	280
20-17	90	180	270	-
20-18	35	110	250	325
20-19	90	180	270	-
20-21	35	110	250	325
20-23	35	110	250	325
20-24	35	110	250	325
20-27	35	110	250	325
20-29	80	-	-	280
22-1	35	110	250	325
22-2	70	145	215	290
22-4	35	110	250	325
22-5	35	110	250	325
22-8	35	110	250	325
22-9	70	145	215	290
22-10	35	110	250	325
22-11	35	110	250	325
22-13	35	110	250	325
22-20	35	110	250	325
22-22	-	110	250	-
22-23	35	-	250	-
22-27	80	-	250	280
22-28	80	-	-	280
24-2	80	-	-	280
24-9	35	110	250	325
24-10	80	-	-	280
24-11	35	110	250	325

Insert Arrangement	Degrees			
	W	X	Y	Z
24-22	45	110	250	-
24-27	80	-	-	280
28-2	35	110	250	325
28-3	70	145	215	290
28-5	35	110	250	325
28-6	70	145	215	290
28-7	35	110	250	325
28-12	90	180	270	-
28-18	70	145	215	290
28-22	70	145	215	290
32-8	80	125	235	280
36-3	70	145	215	290
36-4	70	145	215	290
36-5	-	120	240	-
36-6	35	110	250	325
36-9	80	125	235	280
36-10	80	125	235	280
36-14	90	180	270	-
36-15	60	125	245	305
40-56	72	144	216	288



## Insert Arrangements

Insert Arrangement	Service Rating	Total Contacts	Contact Size				
			0	4	8	12	16
10S-2	A	1					1
10SL-3	A	3					3
10SL-4	A	2					2
12S-3	A	2					2
12S-4	D	1					1
12-5	D	1					1
14S-1	A	3					3
14S-2	Inst	4					4
14S-4	D	1					1
14S-5	Inst	5					5
14S-6	Inst	6					6
14S-7	A	3					3
14S-9	A	2					2
14S-10	Inst	4					4
14S-12	A	3					3
14-3	A	1			1		
14S-A7	A	19	19				
16S-1	A	7					7
16S-3	B	1					1
16S-4	D	2					2
16S-5	A	3					3
16S-6	A	3					3
16S-8	A	5					5
16-2	E	1				1	
16-7	A	3			1	2	
16-9	A	4				2	2
16-10	A	3				3	
16-11	A	2				2	
16-12	A	1		1			
16-13	A	2				2	
18-1	A/Inst	10					10
18-3	D	2				2	
18-4	D	4					4
18-5	D	3				2	1
18-06		6				4	2
18-6	D	1		1			
18-7	B	1			1		
18-8	A	8				1	7
18-9	Inst	7				2	5
18-10	A	4				4	
18-11	A	5				5	
18-12	A	6					6
18-13	A	4			1	3	
18-14	A	2		1			1
18-15	A	4				4	
18-16	C	1				1	
18-17	Inst	7				2	5
18-19	A	10					10
18-20	A	5					5
18-22	D	3					3
18-24	A/Inst	10					10
18-29	A	5					5
18-30	A	5					5
18-31	A	5					5
20-2		1	1				
20-3	D	3				3	
20-4	D	4				4	
20-6	D	3					3
20-7	D/A	8					8

Insert Arrangement	Service Rating	Total Contacts	Contact Size				
			0	4	8	12	16
20-8	Inst	6			2		4
20-9	D/A	8				1	7
20-11	Inst	13					13
20-12	A	2		1			1
20-14	A	5			2	3	
20-15	A	7				7	
20-16	A	9				2	7
20-17	A	6				5	1
20-18	A	9				3	6
20-19	A	3			3		
20-20	A	4		1		3	
20-21	A	9				1	8
20-22	A	6			3		3
20-23	A	2			2		
20-24	A	4			2		2
20-25	Inst	13					13
20-27	A	14					14
20-29	A	17					17
20-30	Inst	13					13
20-33	A	11					11
20-A48	A	19					
22-1	D	2			2		
22-2	D	3			3		
22-4	A	4			2	2	
22-5	D	6				2	4
22-6	D	3			2		1
22-7	E	1	1				
22-8	E	2				2	
22-9	E	3				3	
22-10	E	4					4
22-11	B	2					2
22-12	D	5			2	3	
22-13	D/A	5			4	1	
22-14	A	19					19
22-15	E/A	6				5	1
22-16	A	9				3	6
22-17	D/A	9				1	8
22-18	D/A	8					8
22-19	A	14					14
22-20	A	9					9
22-21	A	3	1				2
22-22	A	4			4		
22-23	D/A	8				8	
22-24	D/A	6				2	4
22-27	D/A	9			1		8
22-28	A	7				7	
22-34	D	5				3	2
24-2	D	7				7	
24-3	D	7				2	5
24-4		1					3
24-5	A	16					16
24-6	D/A	8				8	
24-06	A	6		4			2
24-7	A	16				2	14
24-9	A	2		2			
24-10	A	7			7		

Insert Arrangement	Service Rating	Total Contacts	Contact Size					
			0	4	8	12	16	
24-11	A	9				3	6	
24-12	A	5			2		3	
24-16	D/A	7			1	3	3	
24-17	D	5				2	3	
24-20	D	11					2	9
24-21	D	10				1		9
24-22	D	4			4			
24-27	E	7						7
24-28	Inst	24						24
28-1	D/A	9			3	6		
28-2	D	14					2	12
28-3	E	3				3		
28-4	E/D	9					2	7
28-5	D	5		2			1	2
28-6	D	3		3				
28-7	D	2		2				
28-8	E/D/A	12					2	10
28-9	D	12					6	6
28-09	A	9		4				5
28-10	D/A	7		2	2	3		
28-11	A	22					4	18
28-12	A	26						26
28-13	A	26						26
28-15	A	35						35
28-16	A	20						20
28-17	B/D/A	15						15
28-18	CD/A/Inst	12						12
28-19	B/D/A	10					4	6
28-20	A	14					10	4
28-21	A	37						37
28-22	D	6		3				3
28-51	D	12						12
32-1	D/A	5	2				3	
32-3	D	9	1	2			2	4
32-5	D	2	2					
32-6	A	23		2	3	2	16	
32-7	INSTA	35					7	28
32-8	A	30					6	24
32B-13	D	13			13			
32-17	D	4		4				
32-22	A	54						54
36-1	D	22					4	18
36-3	D	6	3				3	
36-4	D/A	3	3					
36-5	A	4	4					
36-6	A	6	2	4				
36-7	A	47					7	40
36-8	A	47					1	46
36-9	A	31		1	2	14	14	
36-10	A	48						48
36-11	A	48						48
36-12	A	48						48
36-13	E/A	17					2	15
36-14	D	16				5	5	6
36-15	D/A	35						35
36-16	A	47					7	40
36-17	A	47					7	40
38-18	A	31		1	2	14	14	
36-20	A	34			2	2	30	
36-46	A	27						27
36-52	A	52						52
40-56	A	85						85
40-63	A	61						

### Insert Arrangements

Front face of pin insert or rear of socket insert illustrated

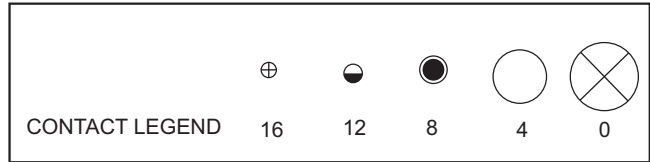

		Front of socket insert	Front of socket insert			
Insert arrangement	10S-2	10SL-3	10SL-4	12S-3	12S-4	12-5
Service rating	A	A	A	A	A	D
Number of contacts	1	3	2	2	1	1
Contact size	16	16	16	16	16	12
Premating contact	-	C	-	-	-	-

Insert arrangement	14S-A7	14S-1	14S-2	14S-4	14S-5	14S-6
Service rating	A	A	Inst.	D	Inst.	Inst.
Number of contacts	7	3	4	1	5	6
Contact size	16	16	16	16	16	16
Premating contact	-	-	-	-	-	-

			100° rotation of 14S-2	100° rotation of 14S-7		
Insert arrangement	14S-7	14S-9	*14S-10	*14S-12	*14-3	16S-1
Service rating	A	A	Inst.	A	A	A
Number of contacts	3	2	4	3	1	7
Contact size	16	16	16	16	8	16
Premating contact	B	-	-	B	-	G

Insert arrangement	*16S-3	16S-4	16S-5	16S-6	16S-8	*16-2
Service rating	B	D	A	A	A	E
Number of contacts	1	2	3	3	5	1
Contact size	16	16	16	16	16	12
Premating contact	-	-	A	B	E	-

\*Not tooled up, can be tooled up on request. Contact Factory.

### Insert Arrangements

Front face of pin insert or rear of socket insert illustrated

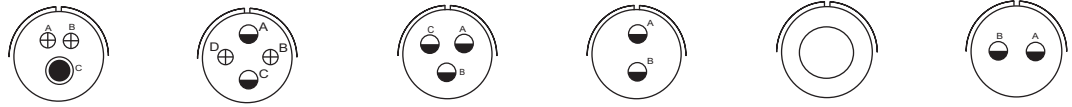
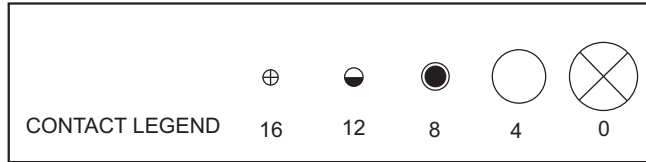

Insert arrangement	16-7	16-9	16-10	16-11	16-12	*16-13
Service rating	A	A	A	A	A	A
Number of contacts	1 2	2 2	3	2	1	2
Contact size	8 16	12 16	12	12	4	12
Premating contact	C	-	B	-	-	-

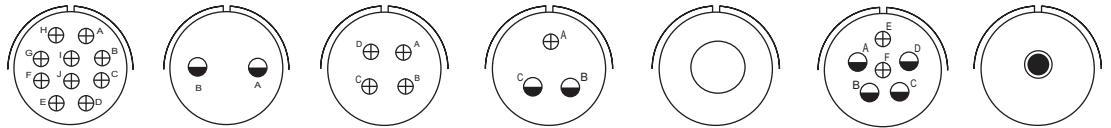

Insert arrangement	18-1	18-3	18-4	18-5	*18-6	18-06	18-7
Service rating	B,C,F,G=A; Bal.=Inst.	D	D	D	D	A	B
Number of contacts	10	2	4	2 1	1	2 4	1
Contact size	16	12	16	12 16	4	16 12	8
Premating contact	-	-	A	C	-	-	-



Insert arrangement	18-8	18-9	18-10	18-11	18-12	*18-13
Service rating	A	Inst.	A	A	A	A
Number of contacts	1 7	2 5	4	5	6	1 3
Contact size	12 16	12 16	12	12	16	8 12
Premating contact	H	-	D	E	C or D	A

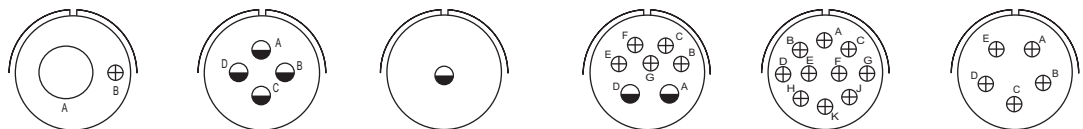

Insert arrangement	*18-14	18-15	18-16	*18-17	18-19	18-20
Service rating	A	A	C	Inst.	A	A
Number of contacts	1 1	4	1	2 5	10	5
Contact size	4 16	12	12	12 16	16	16
Premating contact	-	-	-	-	K	D

100° rotation of 18-9

\*Not tooled up, can be tooled up on request. Contact Factory.

### Insert Arrangements

Front face of pin insert or rear of socket insert illustrated

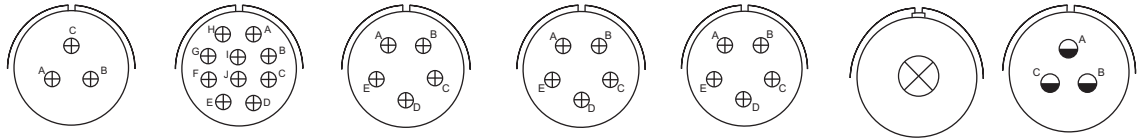
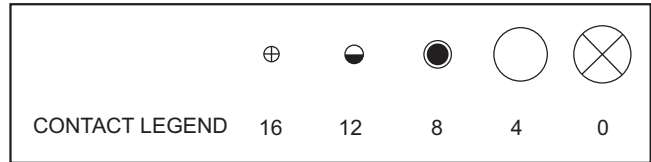

		250° rotation of 18-1		110° rotation of 18-20	260° rotation of 18-20		
Insert arrangement	18-22	*18-24	*18-29	*18-30	*18-31	20-2	20-3
Service rating	D	B,C,F,G=A; Bal.=Inst.	A	A	A	D	D
Number of contacts	3	10	5	5	5	1	4
Contact size	16	16	16	16	16	0	12
Premating contact	C	-	D	C	C	-	A

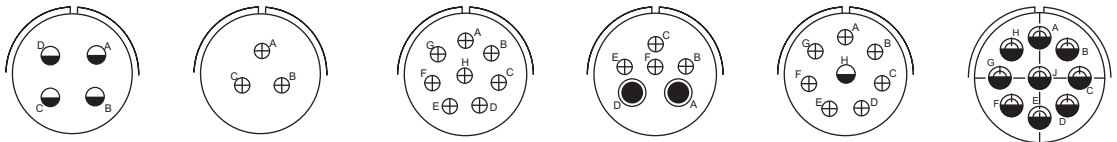

Insert arrangement	20-4	*20-6	20-7	20-8	20-9	20A-9
Service rating	D	D	A,B,H,G=D; C,D,E,F=A	Inst.	H=D; Bal.=A	A
Number of contacts	4	3	8	2 4	1 7	9
Contact size	12	16	16	8 16	12 16	12
Premating contact	C or D	A	A	-	H	-



Insert arrangement	20-11	*20-12	20-14	20-15	20-16	20-17
Service rating	Inst.	A	A	A	A	A
Number of contacts	13	1 1	2 3	7	2 7	5 1
Contact size	16	4 16	8 12	12	12 16	12 16
Premating contact	-	-	D	A or D	E	E or F

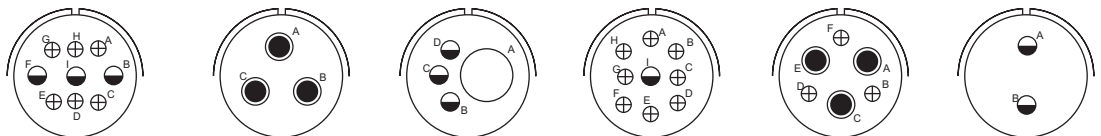

Insert arrangement	20-18	20-19	20-20	*20-21	20-22	20-23
Service rating	A	A	A	A	A	A
Number of contacts	3 6	3	1 3	1 8	3 3	2
Contact size	12 16	8	4 12	12 16	8 16	8
Premating contact	D	C	A	1	-	-

\*Not tooled up, can be tooled up on request. Contact Factory.

### Insert Arrangements

Front face of pin insert or rear of socket insert illustrated

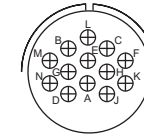
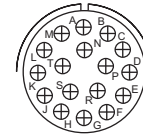
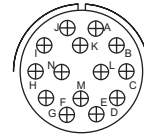
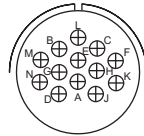
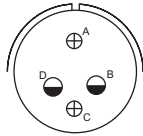
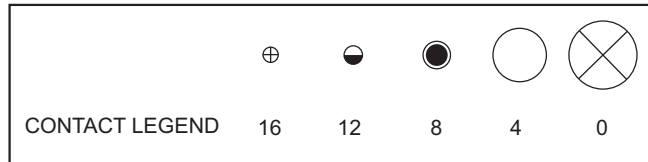

Insert arrangement  
Service rating  
Number of contacts  
Contact size  
Premating contact

20-24  
A  
2 2  
8 16  
-

100° rotation  
of 20-11

\*20-25  
Inst.  
13  
16  
-

20-27  
A  
14  
16  
M

20-29  
A  
17  
16  
G

250° rotation  
of 20-11

\*20-30  
Inst.  
13  
16  
-

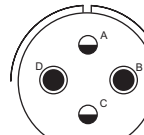
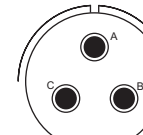
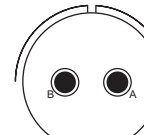
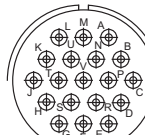
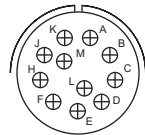

Insert arrangement  
Service rating  
Number of contacts  
Contact size  
Premating contact

20-33  
A  
11  
16  
E

20 A - 48  
A  
19  
16  
-

22-1  
D  
2  
8  
-

22-2  
D  
3  
8  
A

\*22-4  
A  
2 2  
8 12  
C

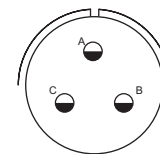
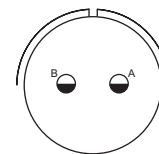
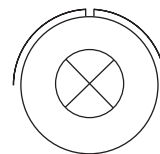
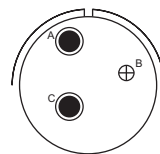
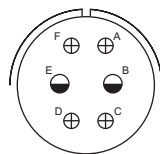

Insert arrangement  
Service rating  
Number of contacts  
Contact size  
Premating contact

22-5  
D  
2 4  
12 16  
D

\*22-6  
D  
2 1  
8 16  
B

22-7  
E  
1  
0  
-

\*22-8  
E  
2  
12  
-

22-9  
E  
3  
12  
A

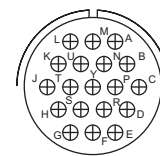
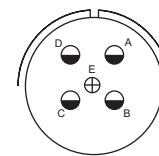
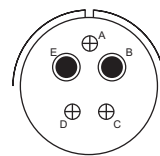
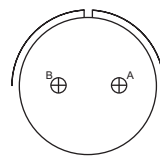
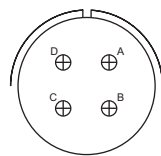

Insert arrangement  
Service rating  
Number of contacts  
Contact size  
Premating contact

22-10  
E  
4  
16  
C

22-11  
B  
2  
16  
-

22-12  
D  
2 3  
8 16  
A

22-13  
E=D; A, B, C, D=A  
4 1  
12 16  
E

22-14  
A  
19  
16  
A

\*Not tooled up, can be tooled up on request. Contact Factory.

### Insert Arrangements

Front face of pin insert or rear of socket insert illustrated

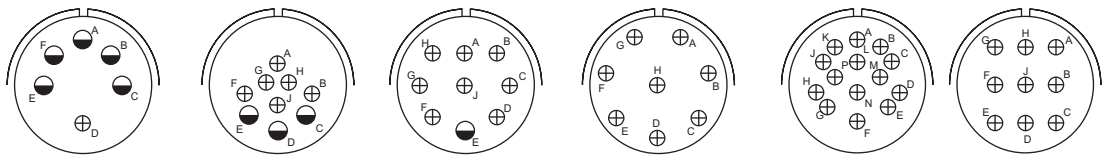
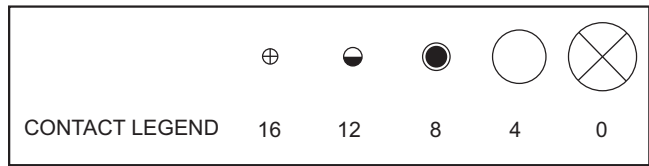

Insert arrangement	22-15	22-16	*22-17	22-18	22-19	22-20
Service rating	D=E;A,B,C,E,F=A	A	A=D;Bal.=A	A,B,F,G,H=D;C,D,E=A	A	A
Number of contacts	5 1	3 6	1 8	8	14	9
Contact size	12 16	12 16	12 16	16	16	16
Premating contact	D	D	E	D	F	D

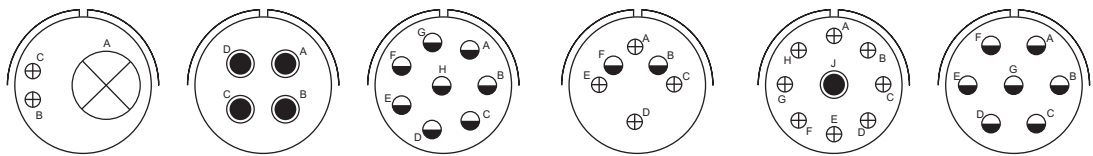

Insert arrangement	*22-21	22-22	22-23	22-24	22-27	22-28
Service rating	A	A	H=D;Bal.=A	C,D,E=D;A,B,F=A	J=D;Bal.=A	A
Number of contacts	1 2	4	8	2 4	1 8	7
Contact size	0 16	8	12	12 16	8 16	12
Premating contact	-	C or D	A or D	D	-	G

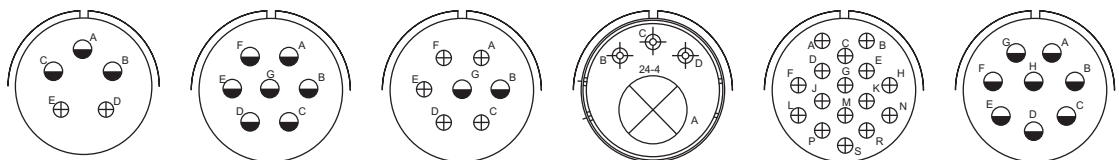

Insert arrangement	*22-34	24-2	*24-3	24-4	24-5	24-6
Service rating	D	D	D	A	A	A,G,H=D;Bal.=A
Number of contacts	3 2	7	2 5	3 1	16	8
Contact size	12 16	12	12 16	16 0	16	12
Premating contact	E	A	D	-	S	D

\*Not tooled up, can be tooled up on request. Contact Factory.

**Insert Arrangements**

Front face of pin insert or rear of socket insert illustrated

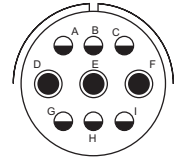
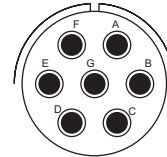
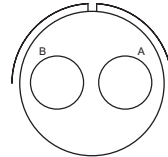
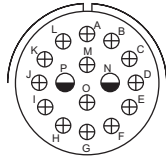
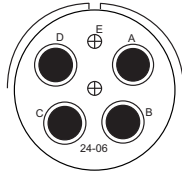
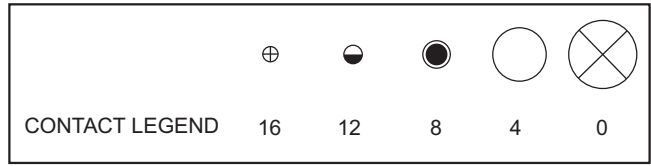

Insert arrangement  
Service rating  
Number of contacts  
Contact size  
Premating contact

24-06  
A  
2 4  
16 8  
-

24-7  
A  
2 14  
12 16  
G

24-9  
A  
2  
4  
-

24-10  
A  
7  
8  
D or E or G

24-11  
A  
3 6  
8 12  
E

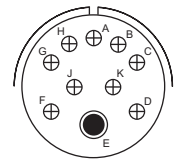
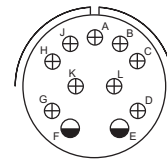
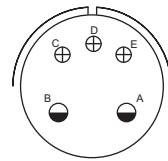
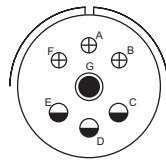
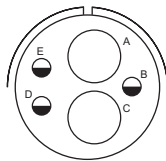

Insert arrangement  
Service rating  
Number of contacts  
Contact size  
Premating contact

24-12  
A  
2 3  
4 12  
-

\*24-16  
A,B,F,G=D;C,D,E=A  
1 3 3  
8 12 16  
G

\*24-17  
D  
2 3  
12 16  
D

24-20  
D  
2 9  
12 16  
A

24-21  
D  
1 9  
8 16  
E

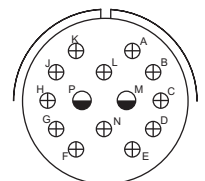
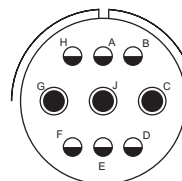
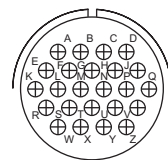
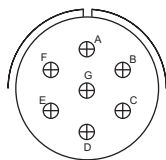
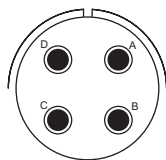

Insert arrangement  
Service rating  
Number of contacts  
Contact size  
Premating contact

24-22  
D  
4  
8  
D

\*24-27  
E  
7  
16  
D

24-28  
Inst.  
24  
16  
-

28-1  
A,J,E=D;Bal.=A  
3 6  
8 12  
E

\*28-2  
D  
2 12  
12 16  
E

\*Not tooled up, can be tooled up on request. Contact Factory.

### Insert Arrangements

Front face of pin insert or rear of socket insert illustrated

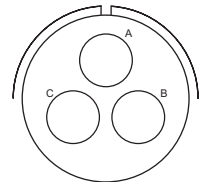
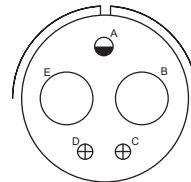
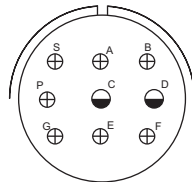
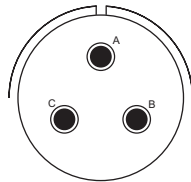
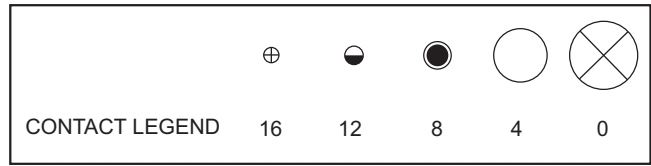

Insert arrangement  
Service rating  
Number of contacts  
Contact size  
Premating contact

28-3  
E  
3  
8  
A

\*28-4  
G,S,P=E; Bal.=D  
2 7  
12 16  
E

\*28-5  
D  
2 1 2  
4 12 16  
-

28-6  
D  
3  
4  
A

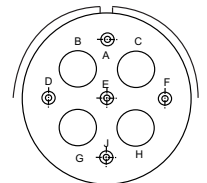
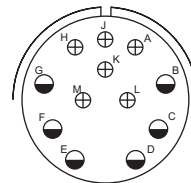
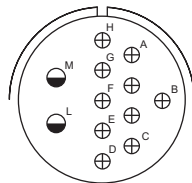
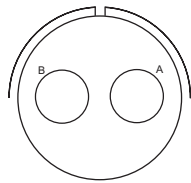

Insert arrangement  
Service rating  
Number of contacts  
Contact size  
Premating contact

28-7  
D  
2  
4  
-

28-8  
L,M=E; B=D; Bal.=A  
2 10  
12 16  
D

28-9  
D  
6 6  
12 16  
E

28-09  
A  
5 4  
16 4  
-

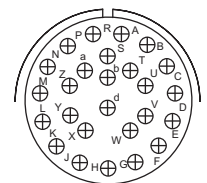
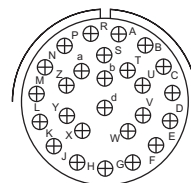
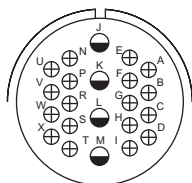
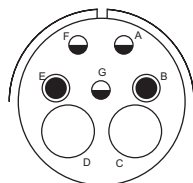

Insert arrangement  
Service rating  
Number of contacts  
Contact size  
Premating contact

28-10  
G=D; Bal.=A  
2 2 3  
4 8 12  
G

28-11  
A  
4 18  
12 16  
M

28-12  
A  
26  
16  
H

100° rotation  
of 28-12  
\*28-13  
A  
26  
16  
H

\*Not tooled up, can be tooled up on request. Contact Factory.



### Insert Arrangements

Front face of pin insert or rear of socket insert illustrated

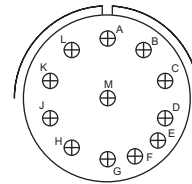
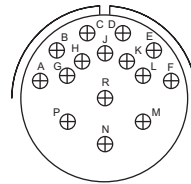
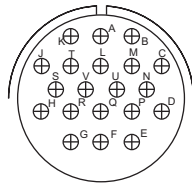
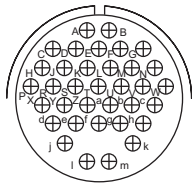
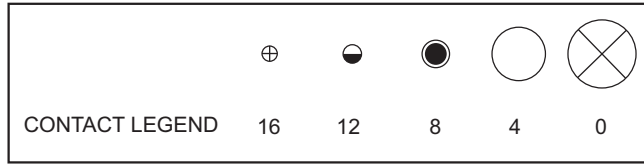

Insert arrangement 28-15  
 Service rating A  
 Number of contacts 35  
 Contact size 16  
 Premating contact M

28-16  
 A  
 20  
 16  
 F

\*28-17  
 R=B;M,N,P=D;A to L=A  
 15  
 16  
 N

28-18  
 M=C;G,H,J,K,L=D;A,B=ABal.=Inst.  
 12  
 16  
 -

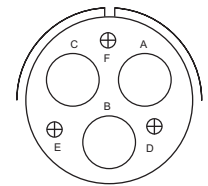
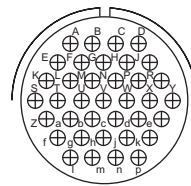
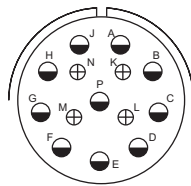
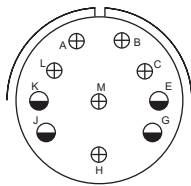

Insert arrangement 28-19  
 Service rating H,M=B;A,B=D;Bal.=A  
 Number of contacts 4 6  
 Contact size 12 16  
 Premating contact H

28-20  
 A  
 10 4  
 12 16  
 E

28-21  
 A  
 37  
 16  
 A

28-22  
 D  
 3 3  
 4 16  
 -

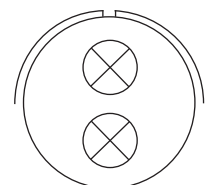
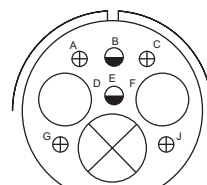
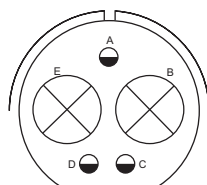
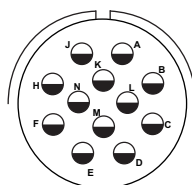

Insert arrangement 28-51  
 Service rating D  
 Number of contacts 12  
 Contact size 12  
 Premating contact -

32-1  
 A=E;B,C,D,E=A  
 2 3  
 0 12  
 -

\*32-3  
 D  
 1 2 2 4  
 0 4 12 16  
 -

32-5  
 D  
 2  
 0

\*Not tooled up, can be tooled up on request. Contact Factory.

### Insert Arrangements

Front face of pin insert or rear of socket insert illustrated

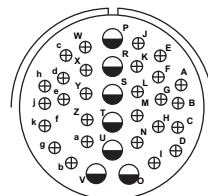
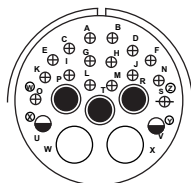
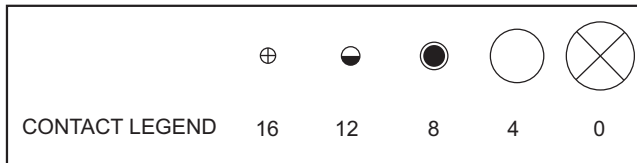

Insert arrangement  
Service rating  
Number of contacts  
Contact size  
Premating contact

32-6  
A  
16 2 3 2  
16 12 8 4  
-

32-7  
INST, A  
4 24 7  
16 12  
-

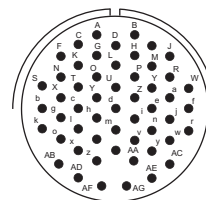
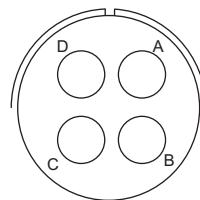
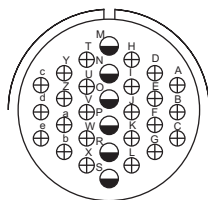

Insert arrangement  
Service rating  
Number of contacts  
Contact size  
Premating contact

32-8  
A  
6 24  
12 16  
S

32-17  
D  
4  
4  
-

32-22  
A  
54  
16  
-

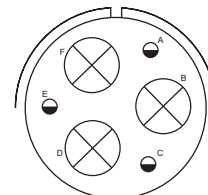
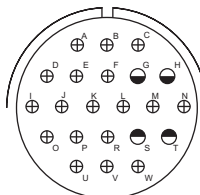
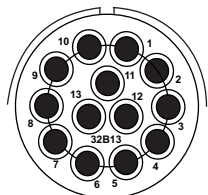

Insert arrangement  
Service rating  
Number of contacts  
Contact size  
Premating contact

32B-13  
D  
13  
8  
-

\*36-1  
D  
4 18  
12 16  
-

36-3  
D  
3 3  
0 12  
-

\*Not tooled up, can be tooled up on request. Contact Factory.

### Insert Arrangements

Front face of pin insert or rear of socket insert illustrated

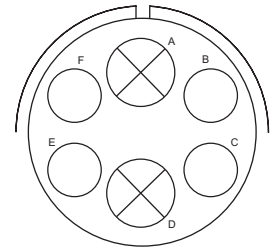
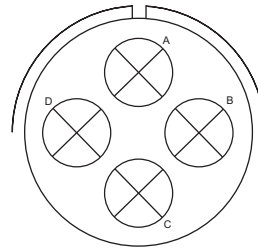
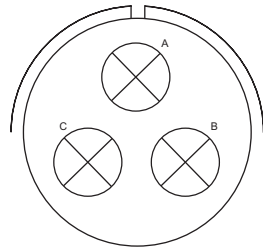
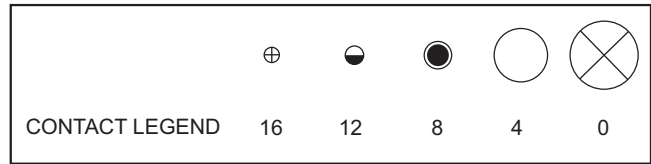

Insert arrangement  
Service rating  
Number of contacts  
Contact size  
Premating contact

**36-4**  
A=D; B, C=A  
3  
0  
-

**36-5**  
A  
4  
0  
-

**36-6**  
A  
2 4  
0 4  
-

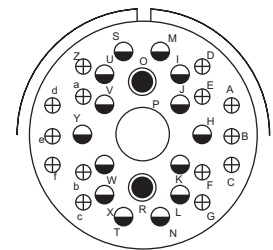
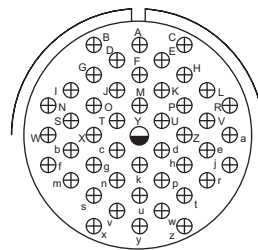
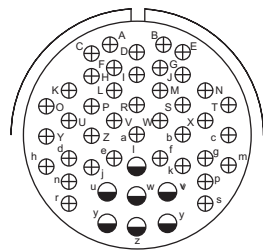

Insert arrangement  
Service rating  
Number of contacts  
Contact size  
Premating contact

**\*36-7**  
A  
7 40  
12 16  
x or y

**\*36-8**  
A  
1 46  
12 16  
Y

**\*36-9**  
A  
1 2 14 14  
4 8 12 16  
P

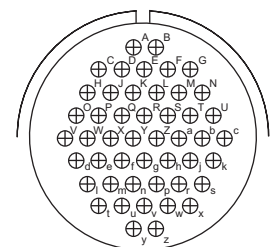
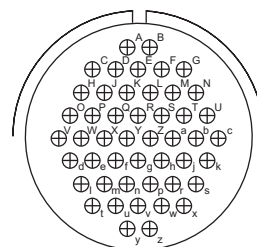
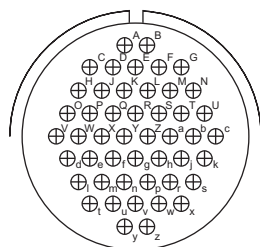

Insert arrangement  
Service rating  
Number of contacts  
Contact size  
Premating contact

**36-10**  
A  
48  
16  
A

100° rotation  
of 36-10  
**\*36-11**  
A  
48  
16  
A

250° rotation  
of 36-10  
**\*36-12**  
A  
48  
16  
A

\*Not tooled up, can be tooled up on request. Contact Factory.

### Insert Arrangements

Front face of pin insert or rear of socket insert illustrated

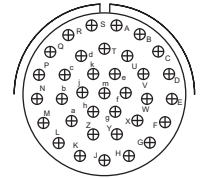
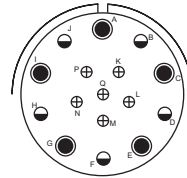
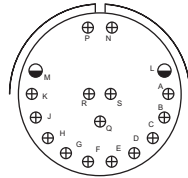
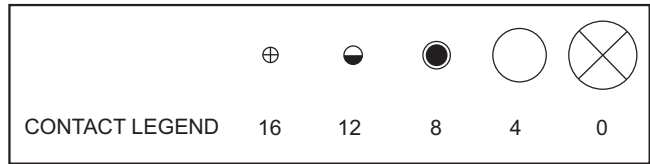

Insert arrangement  
Service rating  
Number of contacts  
Contact size  
Premating contact

**\*36-13**  
N,P,Q=E;Bal.=A  
2 15  
12 16  
-

**\*36-14**  
D  
5 5 6  
8 12 16  
-

**\*36-15**  
M=D;Bal=A  
35  
16  
J

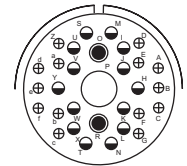
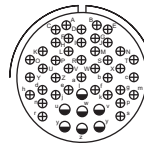
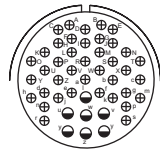

100°rotation  
of 36-7

250°rotation  
of 36-7

100°rotation  
of 36-9

Insert arrangement  
Service rating  
Number of contacts  
Contact size  
Premating contact

**\*36-16**  
A  
7 40  
12 16  
x or y

**\*36-17**  
A  
7 40  
12 16  
x or y

**\*36-18**  
A  
1 2 14 16  
4 8 12 16  
-

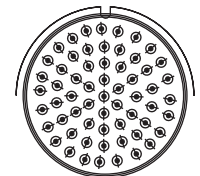
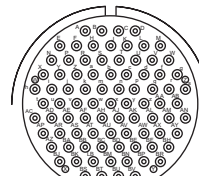
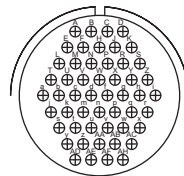
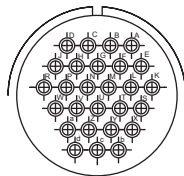
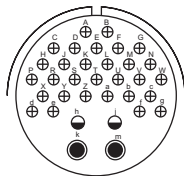

Insert arrangement  
Service rating  
Number of contacts  
Contact size  
Premating contact

**\*36-20**  
A  
2 2 30  
8 12 16  
k

**36-46**  
A  
27  
16  
-

**36-52**  
A  
52  
16  
-

**40-56**  
A  
85  
16  
-

**40-63**  
A  
61  
16  
-

\*Not tooled up, can be tooled up on request. Contact Factory.

**Shell Types**  
**Wall mounting receptacle**  
**MS-3100 MS-4100**

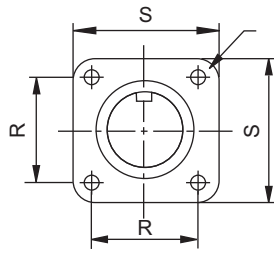
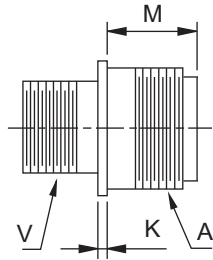

MOUNTING HOLES  
 4.39 DIA. FOR SIZE 32 AND 36  
 3.73 DIA. FOR SIZE 24 AND 28  
 3.05 DIA. FOR ALL OTHER SIZES  
 4.55 DIA. FOR 40 SIZE

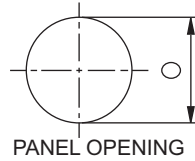

All dimensions are in mm

Connector Size	A Thread in inches	K	M	O	R	S	V Thread in inches
10SL	5/8-24 UNEF	1.98	14.29	20.62	18.25	25.68	5/8-24 NEF
12S	3/4-20 UNEF	1.98	14.29	20.62	20.64	27.76	11/16-24NEF
12	3/4-20 UNEF	1.98	19.05	20.62	20.64	27.76	11/16-24NEF
14S	7/8-20 UNEF	1.98	14.29	23.82	23.02	30.43	3/4-20 UNEF
14	7/8-20 UNEF	1.98	19.05	23.82	23.02	30.43	3/4-20 UNEF
16S	1-20 UNEF	1.98	14.29	26.97	24.61	32.82	7/8-20 UNEF
16	1-20 UNEF	3.17	19.05	26.97	24.61	32.82	7/8-20 UNEF
18	1 1/8-18 UNEF	3.17	19.05	30.17	26.99	35.07	1-20 UNEF
20	1 1/4-18 UNEF	3.17	19.05	33.32	29.37	38.38	1 1/8-18 NS
22	1 3/8-18 UNEF	3.17	19.05	36.52	31.75	41.55	1 1/4-18 NEF
24	1 1/2-18 UNEF	3.17	20.64	39.67	34.92	44.70	1 3/8-18 NEF
28	1 3/4-18 UNS	3.17	20.64	46.02	39.69	51.08	1 5/8-18 NEF
32	2.00-18 UNS	3.17	22.25	53.0	44.45	57.15	1 7/8-16UN
36	2 1/4-16 UN	3.17	22.22	58.72	49.21	63.78	2 1/16-16UN
40	2 1/2-16 UN	3.45	22.22	62.00	55.58	69.85	2 5/16-16 UN

**Cable Connecting Receptacle**  
**MS-3101 MS-4101**

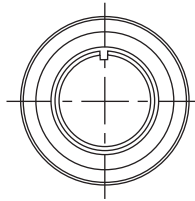
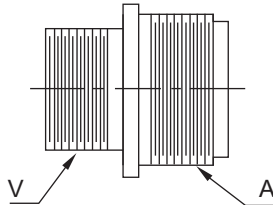

All dimensions are in mm

Connector Size	A Thread in inches	V Thread in inches
10SL	5/8-24 UNEF	5/8-24 NEF
12S	3/4-20 UNEF	11/16-24 NEF
12	3/4-20 UNEF	11/16-24 NEF
14S	7/8-20 UNEF	3/4-20 UNEF
14	7/8-20 UNEF	3/4-20 UNEF
16S	1-20 UNEF	7/8-20 UNEF
16	1-20 UNEF	7/8-20 UNEF
18	1 1/8-18 UNEF	1-20 UNEF
20	1 1/4-18 UNEF	1 1/8-18 NS
22	1 3/8-18 UNEF	1 1/4-18 NEF
24	1 1/2-18 UNEF	1 3/8-18 NEF
28	1 3/4-18 UNS	1 5/8-18 NEF
32	2-18 UNS	1 7/8-16UN
36	2 1/4-16 UN	2 1/16-16UN
40	2 1/2-16 UN	2 5/16-16 UN

**Shell Types**  
**Box mounting receptacle**  
**MS-3102 MS-4102**

MOUNTING HOLES  
 4.39 DIA. FOR SIZE 32 AND 36  
 3.73 DIA. FOR SIZE 24 AND 28  
 3.05 DIA. FOR ALL OTHER SIZES  
 4.55 FOR 40 SIZE

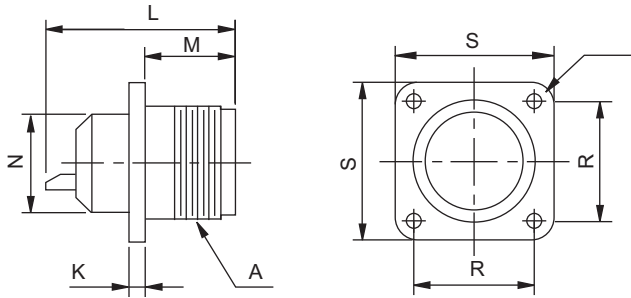

All dimensions are in mm

Connector Size	A Thread in inches	K	L	M	N	R	S
10SL	5/8-24 UNEF	1.98	30.18	13.89	15.87	18.25	25.68
12S	3/4-20 UNEF	1.98	30.18	14.28	17.46	20.64	28.04
12	3/4-20 UNEF	1.98	41.28	19.05	17.46	20.64	28.04
14S	7/8-20 UNEF	1.98	30.18	14.28	19.05	23.02	30.43
14	7/8-20 UNEF	1.98	41.28	19.05	19.05	23.02	30.43
16S	1-20 UNEF	1.98	30.18	14.28	22.22	24.61	32.82
16	1-20 UNEF	3.17	41.28	19.05	22.22	24.61	32.82
18	1 1/8-18 UNEF	3.17	49.28	19.05	25.40	26.99	35.08
20	1 1/4-18 UNEF	3.17	49.28	19.05	28.57	29.37	38.38
22	1 3/8-18 UNEF	3.17	49.28	19.05	31.75	31.75	41.55
24	1 1/2-18 UNEF	3.17	49.28	20.64	34.92	34.92	44.73
28	1 3/4-18 UNS	3.17	49.28	20.64	41.27	39.69	51.08
32	2-18 UNS	3.17	49.28	22.22	48.26	44.45	57.15
36	2 1/4-16 UN	3.17	49.28	22.22	53.97	49.21	63.78
40	2 1/2-16 UN	3.45	49.28	22.22	58.25	55.58	69.85

**Straight Plug**  
**MS-3106 MS-4106**

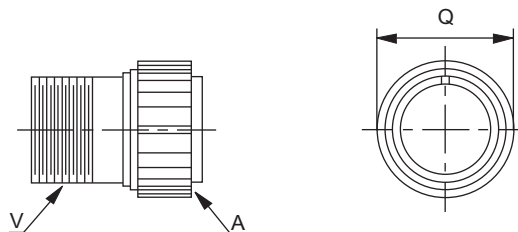

All dimensions are in mm

Connector Size	A Thread in inches	Q max	V Thread in inches
10SL	5/8-24 UNEF	19.05	5/8-24 NEF
12S	3/4-20 UNEF	19.84	11/16-24NEF
12	3/4-20 UNEF	19.84	11/16-24NEF
14S	7/8-20 UNEF	22.22	3/4-20 UNEF
14	7/8-20 UNEF	22.22	3/4-20 UNEF
16S	1-20 UNEF	25.40	7/8-20 UNEF
16	1-20 UNEF	25.40	7/8-20 UNEF
18	1 1/8-18 UNEF	28.57	1-20 UNEF
20	1 1/4-18 UNEF	31.75	1 1/8-18 NS
22	1 3/8-18 UNEF	34.92	1 1/4-18 NEF
24	1 1/2-18 UNEF	38.10	1 3/8-18 NEF
28	1 3/4-18 UNS	44.45	1 5/8-18 NEF
32	2-18 UNS	51.75	1 7/8-16UN
36	2 1/4-16 UN	57.15	2 1/16-16UN
40	2 1/2-16 UN	63.50	2 5/16-20 UN

Note - Both versions, straight and diamond knurling available on coupling ring. For details, contact factory.

**Shell Types**  
**Right angle plug**  
**MS-3108 MS-4108**

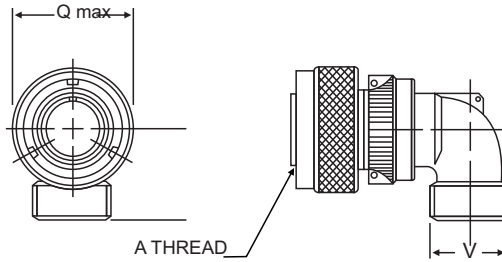

All dimensions are in mm

Connector Size	A Thread in inches	Q max	V Thread in inches
10SL	5/8-24 UNEF	19.05	5/8-24 NEF
12S	3/4-20 UNEF	19.84	11/16-24 NEF
12	3/4-20 UNEF	19.84	11/16-24 NEF
14S	7/8-20 UNEF	22.22	3/4-20 UNEF
14	7/8-20 UNEF	22.22	3/4-20 UNEF
16S	1-20 UNEF	25.40	7/8-20 UNEF
16	1-20 UNEF	25.40	7/8-20 UNEF
18	1 1/8-18 UNEF	28.57	1-20 UNEF
20	1 1/4-18 UNEF	31.75	1 1/8-18 NS
22	1 3/8-18 UNEF	34.92	1 1/4-18 NEF
24	1 1/2-18 UNEF	38.10	1 3/8-18 NEF
28	1 3/4-18 UNS	44.45	1 5/8-18 NEF
32	2-18 UNS	51.75	1 29/32-18 NS
36	2 1/4-16 NS	57.15	2 1/16-20 UNS
40	2 1/2-16 UN	63.50	2 5/16-16 UN

Note - Both versions, straight and diamond knurling available on coupling ring. For details, contact factory.

**Shell Types**  
**Box mounting receptacle**  
**97B-3100 97B-4100**

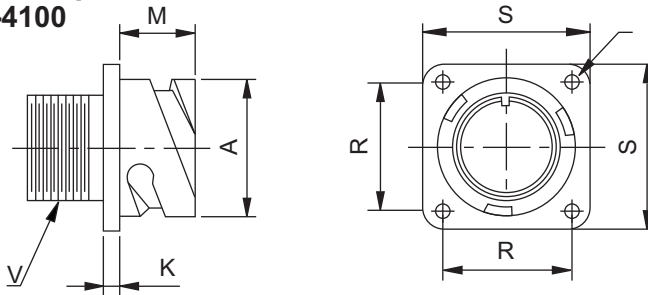

MOUNTING HOLES  
 4.39 DIA. FOR SIZE 32 , 36 AND 40  
 3.73 DIA. FOR SIZE 24 AND 28  
 3.05 DIA. FOR ALL OTHER SIZES

All dimensions are in mm

Connector Size	A	K	M	R	S	V Thread in inches
10SL	18.2	2.8	14.2	18.2	25.4	5/8-24 NEF
14S	24.6	3.2	14.2	23.0	30.0	3/4-20 UNEF
16S	27.4	3.2	14.2	24.6	32.5	7/8-20 UNEF
16	27.4	3.2	19.0	24.6	32.5	7/8-20 UNEF
18	30.8	4.0	19.0	27.0	35.0	1-20 UNEF
20	34.2	4.0	19.0	29.4	38.0	1 1/8-24 NS
22	37.4	4.0	19.0	31.8	41.0	1 1/4-18 NEF
24	40.9	4.0	20.6	34.9	44.5	1 3/8-18 NEF
28	46.7	4.0	20.6	39.7	50.8	1 5/8-18 NEF
32	53.4	4.0	22.2	44.5	57.0	1 7/8-16UN
36	59.6	4.0	22.2	49.2	63.5	2 1/16-16UN
40	65.5	4.0	22.2	55.5	69.85	2 5/16-16 UN

**Cable Connecting Receptacle**  
97B-3101 97B-4101

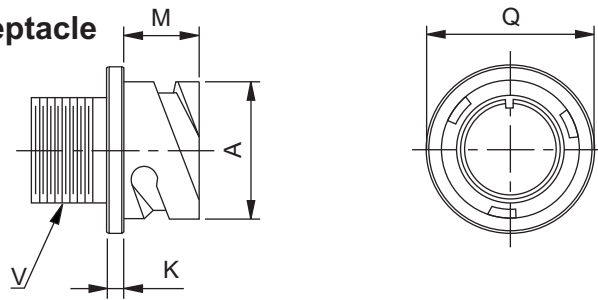

All dimensions are in mm

Connector Size	A	K	M	V Thread in inches
10SL	18.2	2.8	14.2	5/8-24 NEF
14S	24.6	3.2	14.2	3/4-20 UNEF
16S	27.4	3.2	14.2	7/8-20 UNEF
16	27.4	3.2	19.0	7/8-20 UNEF
18	30.8	4.0	19.0	1-20 UNEF
20	34.2	4.0	19.0	1 1/8-24 NS
22	37.4	4.0	19.0	1 1/4-18 NEF
24	40.9	4.0	20.6	1 3/8-18 NEF
28	46.7	4.0	20.6	1 5/8-18 NEF
32	53.4	4.0	22.2	1 7/8-16UN
36	59.6	4.0	22.2	2 1/16-16UN
40	65.5	4.0	22.2	2 5/16-16 UNS

**Shell Types**

**Front box mounting receptacle**  
97B-3102 97B-4102

MOUNTING HOLES  
4.39 DIA. FOR SIZE 32, 36 AND 40  
3.73 DIA. FOR SIZE 24 AND 28  
3.05 DIA. FOR ALL OTHER SIZES

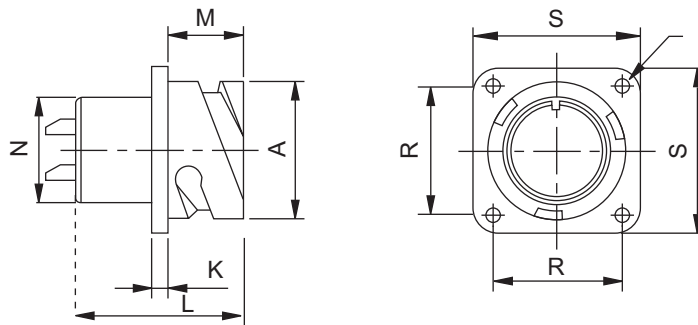

All dimensions are in mm

Connector Size	A	K	M	R	S	N max	L max
10SL	18.2	2.8	14.2	18.2	25.4	15.9	24.7
14S	24.6	3.2	14.2	23.0	30.0	19.2	24.7
16S	27.4	3.2	14.2	24.6	32.5	22.4	24.7
16	27.4	3.2	19.0	24.6	32.5	22.4	33.8
18	30.8	4.0	19.0	27.0	35.0	25.6	34.5
20	34.2	4.0	19.0	29.4	38.0	29.0	34.5
22	37.4	4.0	19.0	31.8	41.0	32.2	34.5
24	40.9	4.0	20.6	34.9	44.5	35.3	35.7
28	46.7	4.0	20.6	39.7	50.8	41.4	35.7
32	53.4	4.0	22.2	44.5	57.0	47.8	37.3
36	59.6	4.0	22.2	49.2	63.5	52.4	37.3
40	65.5	4.0	22.2	55.5	69.85	58.70	37.3



**Back Box Mounting Receptacle**

97B-3103 / 97B-4103

97B-3103X\* / 97B-4103X\*

MOUNTING HOLES  
 4.39 DIA. FOR SIZE 32 , 36 AND 40  
 3.73 DIA. FOR SIZE 24 AND 28  
 3.05 DIA. FOR ALL OTHER SIZES

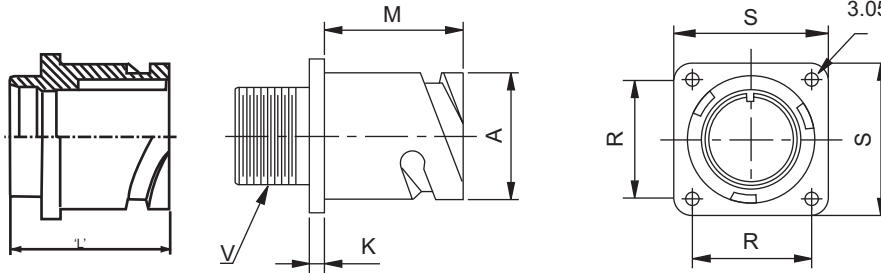

\* Replace X with Required Class

All dimensions are in mm

Connector Size	A	K	M	R	S	V Thread in inches	L REF.
10SL	18.2	2.8	18.2	18.2	25.4	5/8-24 NEF	27.60
14S	24.6	3.2	18.2	23.0	30.0	3/4-20 UNEF	
16S	27.4	3.2	18.2	24.6	32.5	7/8-20 UNEF	
16	27.4	3.2	21.5	24.6	32.5	7/8-20 UNEF	33.81
18	30.8	4.0	23.05	27.0	35.0	1-20 UNEF	
20	34.2	4.0	23.05	29.4	38.0	1 1/8-24 NS	
22	37.4	4.0	23.05	31.8	41.0	1 1/4-18 NEF	
24	40.9	4.0	23.05	34.9	44.5	1 3/8-18 NEF	35.71
28	46.7	4.0	24.05	39.7	50.8	1 5/8-18 NEF	37.31
32	53.4	4.0	24.05	44.5	57.0	1 7/8-16UN	
36	59.6	4.0	24.05	49.2	63.5	2 1/16-16UN	
40	65.5	4.0	24.05	55.5	69.85	2 5/16-16 UN-2A	

**Shell Types**

**Straight plug**

97B-3106 97B-4106

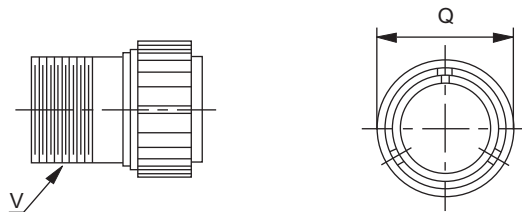

All dimensions are in mm

Connector Size	Q max	V Thread in inches
10SL	22.8	5/8-24 NEF
14S	29.2	3/4-20 UNEF
16S	32.0	7/8-20 UNEF
16	32.0	7/8-20 UNEF
18	36.5	1-20 UNEF
20	39.9	1 1/8-18 NS
22	43.1	1 1/4-18 NEF
24	46.6	1 3/8-18 NEF
28	53.4	1 5/8-18 NEF
32	60.1	1 7/8-16UN
36	66.3	2 1/16-16UN
40	69.10	2 5/16-16 UN

**Right Angle Plug**  
**97B-3108 97B-4108**

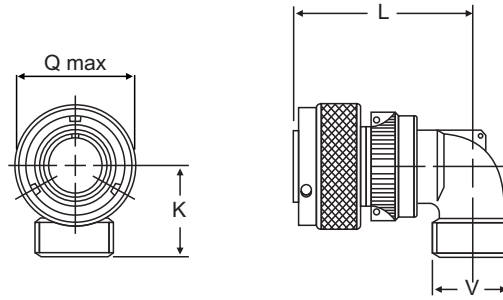

All dimensions are in mm

Connector Size	Q max	V Thread in inches	L max	K max
10SL	22.8	5/8-24 NEF	45	30
14S	29.2	3/4-20 UNEF	47	30
16S	32.0	7/8-20 UNEF	48	30
16	32.0	7/8-20 UNEF	57	35
18	36.5	1-20 UNEF	58	35
20	39.9	1 1/8-18 NS	61	35
22	43.1	1 1/4-18 NEF	61	35
24	46.6	1 3/8-18 NEF	66	40
28	53.4	1 5/8-18 NEF	66	40
32	60.1	1 29/32-18 NS	72	45
36	66.3	2 1/16-20 UNS	75	50
40	69.10	2 5/16-16 UN	78	55

Note - Both versions, straight and diamond knurling available on coupling ring. For details, contact factory.

**Shell Types**  
**Jam nut receptacle**  
**97B - 3107R 97B-4107R**

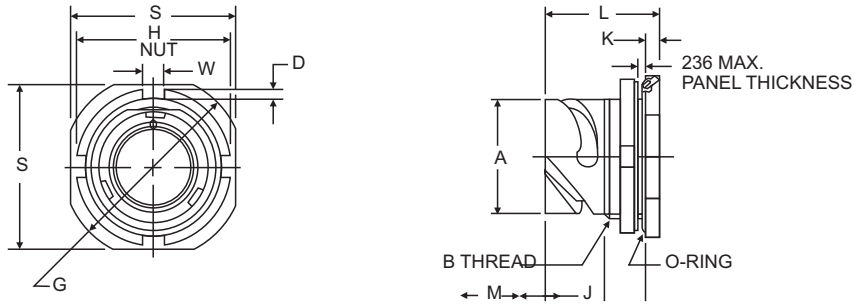

All dimensions are in mm

Shell Size	A Ref.	D Ref.	G Ref.	H Ref.	J Ref.	K Ref.	L Ref.	M Ref.	S ± 0.3	W Ref.
10SL	18.2	2.5	35.0	31.5	13.5	3.2	29.2	12.5	31.8	5.0
14S	24.6	2.5	41.3	37.9	13.5	3.2	29.2	12.5	38.1	6.0
16S	27.4	2.5	44.4	41.0	13.5	3.2	29.2	12.5	41.2	6.0
16	27.4	2.5	44.4	41.0	13.5	3.2	37.7	21.0	41.2	6.0
18	30.8	3.0	48.2	44.8	15.0	4.0	40.0	21.0	45.0	7.0
20	34.1	3.0	52.4	49.0	15.0	4.0	40.0	21.0	49.2	7.0
22	37.3	3.0	55.5	52.2	15.0	4.0	40.0	21.0	52.4	7.0
24	40.8	3.0	59.0	55.0	15.0	4.0	40.0	21.0	55.2	7.0
28	46.7	3.0	66.0	62.0	15.0	4.0	40.0	21.0	62.2	7.0
32	53.3	3.0	72.0	68.0	15.0	4.0	40.0	21.0	68.2	7.0
36	59.6	3.0	80.0	75.0	15.0	4.0	40.0	21.0	75.2	8.0

**Shell Types**  
**Jam nut receptacle**  
**97B - 3107 97B-4107**

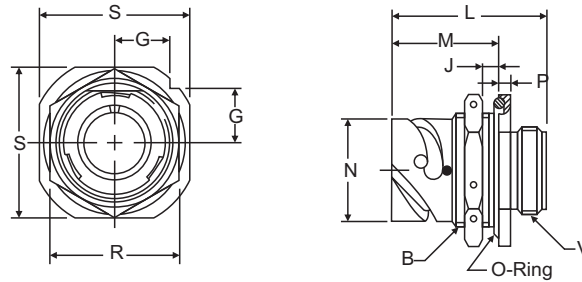

All dimensions are in mm

Shell Size	G ± 0.3	J Wall Thickness		L ± 0.3	M ± 0.3	N +0.00 -0.15	P ± 0.2	R ± 0.4	S ± 0.3	Thread in inches
		Min.	Max.							
10SL	11.2	2.4	5.2	36.2	24.5	18.2	4.0	27	31.8	5/8-24 NEF
14S	14.6	2.4	7.5	38.9	26.8	24.6	4.8	33	41.3	3/4-20 UNEF
16S	15.7	2.4	7.5	38.9	26.8	27.4	4.8	38	44.4	7/8-20 UNEF
16	15.7	2.4	7.5	48.5	32.1	27.4	4.8	38	44.4	7/8-20 UNEF
18	16.8	2.4	9.0	49.3	33.7	30.8	4.8	40	47.6	1-20 UNEF
20	18.0	2.4	9.1	49.3	33.7	34.2	4.8	44	50.8	1 1/8-18 NS
22	20.0	2.4	9.1	49.3	33.7	37.4	4.8	51	57.2	1 1/4-18 NEF
24	20.2	2.4	9.1	49.6	33.7	40.9	4.8	51	57.2	1 3/8-18 NEF
28	22.5	2.4	10.0	51.9	35.2	46.7	5.6	56	63.5	1 5/8-18 NEF
32	24.7	2.4	10.0	51.9	35.2	53.4	5.6	62	69.8	1.7/8-16UN
36	26.9	2.4	8.3	51.9	35.2	59.6	5.6	71	76.2	2 1/16-20 UNS
40	29.6	2.4	8.3	51.9	35.2	65.5	5.6	76	82.5	2 5/16-16 UN

**Shell Types**  
**Panel mounting plug connector**  
**97B - 3110X 97B-4110X**

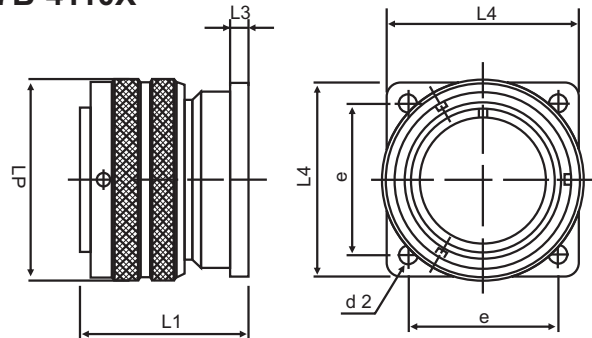

All dimensions are in mm

Shell Size	d <sub>1</sub> Max	d <sub>2</sub> H13	e ± 0.1	l <sub>1</sub> ~	l <sub>3</sub> ± 0.2	l <sub>4</sub> ± 0.3
10SL	22.8	3.2	18.2	28.1	2.8	25.4
14S	29.2	3.2	23	28.1	3.2	30
16S	32	3.2	24.6	28.1	3.2	32.5
16	32	3.2	24.6	37.6	3.2	32.5
18	36.5	3.2	27	38.6	4	35
20	39.9	3.2	29.4	38.6	4	38
22	43.1	3.2	31.8	38.6	4	41
24	46.6	3.7	34.9	41	4	44.5
28	53.4	3.7	39.7	41.8	4	50.8
32	60.1	4.3	44.5	45	4	57
36	66.3	4.3	49.2	45	4	63.5
40	72.5	4.3	55.5	45	4	69.9

**Back Accessories**

**Solid backshell without grommet and sleeve**

**Class A**

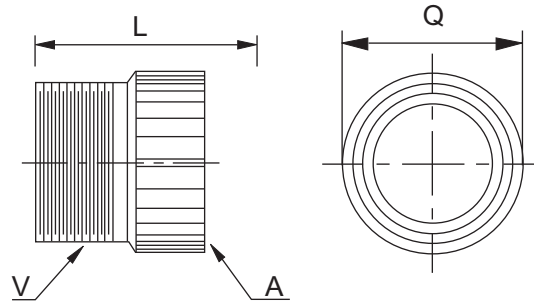

All dimensions are in mm

Connector Size	A Thread in inches	L max for MS	L max for 97B	Q max	V Thread in inches
10SL	5/8-24 NEF	32.54	37.60	19.05	5/8-24 UNEF
12S	11/16-24 NEF	37.31	---	19.84	5/8-24 UNEF
12	11/16-24 NEF	46.83	---	19.84	5/8-24 UNEF
14S	3/4-20 UNEF	36.51	37.64	22.22	3/4-20 UNEF
14	3/4-20 UNEF	46.83	---	22.22	3/4-20 UNEF
16S	7/8-20 UNEF	37.70	38.83	25.40	7/8-20 UNEF
16	7/8-20 UNEF	48.02	48.00	25.40	7/8-20 UNEF
18	1-20 UNEF	50.80	51.58	28.57	1-20 UNEF
20	1 1/8-18 NS	53.97	54.75	31.75	1 3/16-18 UNEF
22	1 1/4-18 NEF	53.97	54.75	34.92	1 3/16-18 UNEF
24	1 3/8-18 NEF	57.15	57.94	38.10	1 7/16-18 UNEF
28	1 5/8-18 NEF	57.15	57.94	44.45	1 7/16-18 UNEF
32	1 7/8-16UN	59.0	59.78	51.75	1 3/4-18 UNS
36	2 1/16-16UN	60.32	61.13	57.15	2-18 UNS
40	2 5/16-16 UN	71.80	80.00	63.50	2 1/4 - 16 UN

**Solid Backshell With Grommet & Sleeve**

**Class R**

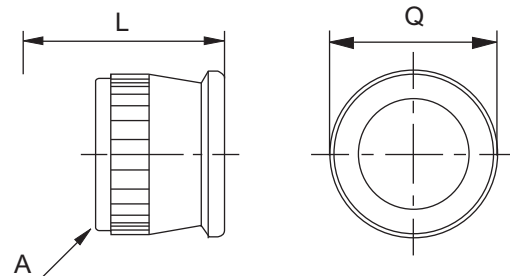

All dimensions are in mm

Connector Size	A Thread class 2B in inches	For Plug type L max for MS	For Receptacle L max for 97B	Q max
10SL	5/8-24 NEF	47	48	21.50
12S	11/16-24 NEF	47	---	20.35
12	11/16-24 NEF	55	---	20.35
14S	3/4-20 UNEF	47	48	23.40
14	3/4-20 UNEF	55	---	23.40
16S	7/8-20 UNEF	47	48	26.71
16	7/8-20 UNEF	55	56	26.71
18	1-20 UNEF	57	57	29.50
20	1 1/8-18 NS	57	57	35.70
22	1 1/4-18 NEF	57	57	35.85
24	1 3/8-18 NEF	57	57	44.40
28	1 5/8-18 NEF	57	57	45.08
32	1 7/8-16UN	58.25	60	52.36
36	2 1/16-16UN	58.25	60	56.81
40	2 5/16-16 UN	58.25	60	64.50

Note - Both versions, straight and diamond knurling available on back accessories. For details, contact factory.

**Back Accessories**  
**Strain relief backshell with grommet and sleeve**  
**Class E and F**

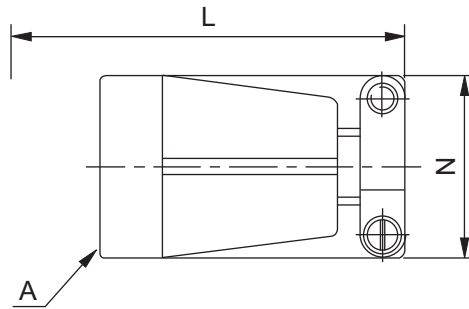

All dimensions are in mm

Connector Size	A Thread class 2B in inches	L max for MS	L max for 97B	N max
10SL	5/8-24 NEF	54.07	59.10	21.97
12S	11/16-24 NEF	54.07	---	21.97
14S	3/4-20 UNEF	55.90	61.34	25.15
16S	7/8-20 UNEF	55.90	62.86	28.45
16	7/8-20 UNEF	64.41		28.45
18	1-20 UNEF	65.94	71.10	30.76
20	1 1/8-18 NS	67.41	72.55	37.29
22	1 1/4-18 NEF	67.41	72.55	37.29
24	1 3/8-18 NEF	73.28	76.82	44.45
28	1 5/8-18 NEF	73.28	77.82	44.45
32	1 7/8-16UN	74.75		52.22
36	2 1/16-16UN	74.75	77.64	57.15
40	2 5/16-16 UN	86.0	125.0	67.10

**Right Angle Backshell With Or Without Grommet**  
**Class A, F & R**

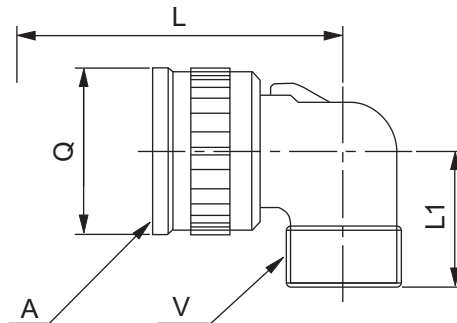

All dimensions are in mm

Connector Size	A Thread class 2B in inches	L max for MS	L max for 97B	L1 max	Q max	V Thread in inches
10SL	5/8-24 NEF	37.60	45.00	25.00	22.22	5/8-24 UNEF
12S	11/16-24 NEF	37.80	---	25.00	25.40	5/8-24 UNEF
12	11/16-24 NEF	47.30	---	25.00	25.40	5/8-24 UNEF
14S	3/4-20 UNEF	39.40	47.00	27.00	28.57	3/4-20 UNEF
14	3/4-20 UNEF	48.90	---	27.00	28.57	3/4-20 UNEF
16S	7/8-20 UNEF	42.60	48.00	28.00	31.75	7/8-20 UNEF
16	7/8-20 UNEF	52.10	57.00	28.00	31.75	7/8-20 UNEF
18	1-20 UNEF	53.70	58.00	31.00	34.13	1-20 UNEF
20	1 1/8-18 NS	58.80	61.00	34.00	37.30	1 3/16-18 UNEF
22	1 1/4-18 NEF	58.80	61.00	34.00	40.48	1 3/16-18 UNEF
24	1 3/8-18 NEF	63.60	66.00	37.00	43.66	1 7/16-18 UNEF
28	1 5/8-18 NEF	63.60	66.00	39.00	50.00	1 7/16-18 UNEF
32	1 7/8-16UN	69.60	72.00	45.00	56.50	1 3/4-18 UNS
36	2 1/16-16UN	72.80	75.00	48.00	62.71	2-18 UNS
40	2 5/16-26 UN	76.00	78.00	55.00	62.71	2 1/4 -16 UN

Note - Both versions, straight and diamond knurling available on back accessories. For details, contact factory.

**PG Adaptor**

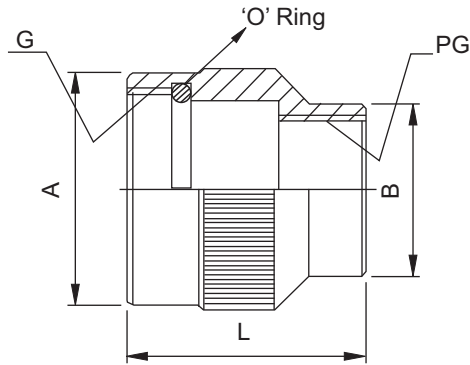

Shell size	G Thread in inches	PG 9			PG 11			PG 13			PG 16			PG 21			PG 29			PG 36			
		A	B	L	A	B	L	A	B	L	A	B	L	A	B	L	A	B	L	A	B	L	
10SL	5/8-24																						
12S	11/16-24																						
14	3/4-20				23	23	30	23	23	30													
16	7/8-20				25	25	30				25	25	30										
18	1-20	30	21	26	30	26	37				30	28	37										
20	1 1/8-18				35	26	40				35	28	40	35	35	40							
22	1 1/4-18										35	28	40	35	35	40							
24	1 3/8-18													38	35	40	40	40	40				
28	1 5/8-18													45	37	45	45	45	45				
36	2 1/8-18																57	44	55	57	57	55	

Ordering Information  
 MS - XX-PGY  
 Where XX- Shell Size  
 YY-PG-Thread Size

**EGM/PHM Backshell Accessories**

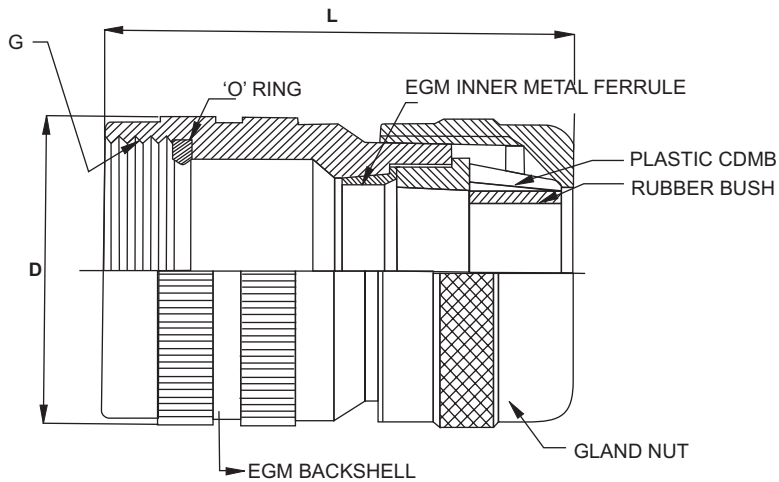

Shell size	G Thread in inches	EGM/PHM 11		EGM/PHM 21	
		D	L	D	L
10SL	5/8"-24	25.00	37.00	27.00	41.00
12SL	11/16"-24	25.00	37.00	27.00	41.00
14	3/4"-20	25.00	37.00	27.00	41.00
16	7/8"-20	25.00	40.00	27.00	43.00
18	1"-20	29.00	40.00	31.00	43.00
20	1.1/8"-18	31.50	52.00	33.50	55.00
22	1.1/4"-18	35.00	60.00	35.00	60.00
24	1.3/8"-18	35.00	60.00	35.00	60.00
32	1.29/32"-18	52.00	70.00	52.00	70.00
36	2.1/6"-18	52.00	70.00	52.00	70.00

Note:- Rubber Bush supplied in Packing  
 In case of PHM inner metal Furrele is not required/supplied  
 EGM/PHM11 Can accept cable Min. 5.70 mm & Max. 10.85 mm  
 EGM/PHM21 Can accept cable Min. 12.70 mm & Max. 17.85 mm

**Heat Shrink  
Boot adaptor (G)**

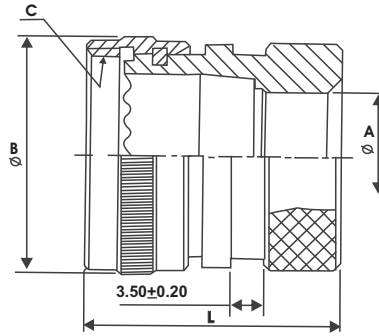

Shell size	A Min.	B	L Max.	C- THD
10SL	7.70	20.30	30.00	5/8-24 NEF
12S	8.20			
14S	10.60	22.30	27.00	3/4-20 UNEF
16S	13.50	24.80	29.50	7/8-20 UNEF
16				
18	14.60	28.50	33.50	1-20 UNEF
20	18.70	34.50		1 1/8-18 NEF
22	20.80	35.10	35.70	1 1/4-18 UNEF
24	24.60	41.00	34.00	1 3/8-18 NEF
28	27.00	44.80	34.10	1 5/8-18 NEF
32	33.30	51.50	34.20	1 7/8-16 UN
36	38.50	56.00	34.20	2 1/16-16 UN
40	48.20	62.00	36.60	2 5/16-16 UN

**Back Accessories**

**Cable clamp**

**MS-3057**

Use MS-3420 sleeves

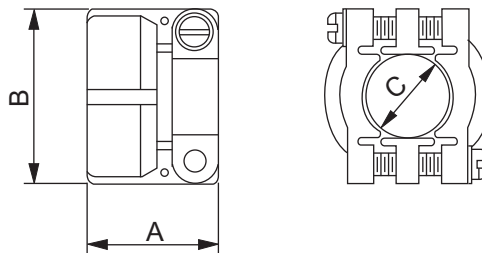

All dimensions are in mm

Part number	Shell size	Max OD of cable	A	B	C	Thread in inches
MS-3057-4A	10SL, 12S	5.59	20.90	21.39	7.94	5/8-24
MS-3057-6A	14, 14S	7.92	21.59	25.27	11.11	3/4-20
MS-3057-8A	16, 16S	11.10	23.37	28.45	14.29	7/8-20
MS-3057-10A	18	14.27	23.37	30.89	15.87	1-20
MS-3057-12A	20,22	15.87	23.07	35.03	19.50	1 3/16-18
MS-3057-16A	24,28	19.05	25.78	42.75	23.81	1 7/16-18
MS-3057-20A	32	23.80	28.00	51.00	31.70	1 3/4-18
MS-3057-24A	36	31.75	29.36	57.02	34.92	2-18

**Neoprene Sleeve  
MS-3420**

Rubber bushing. Protects wire bundles and unjacketed cables from possible damage by cable clamp.

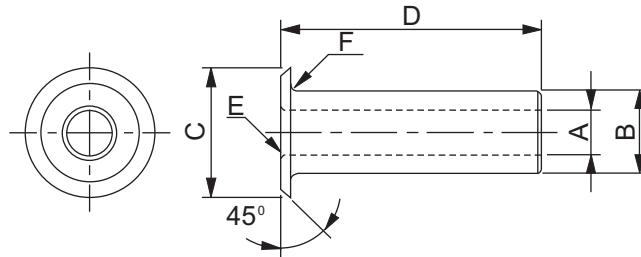

All dimensions are in mm

Part number	A	B	C	D	E Rad in inches	F Rad in inches
MS-3420-3	3.30	5.33	9.50	73.02	0.79	0.79
MS-3420-4	5.59	7.67	12.70	69.85	0.79	0.79
MS-3420-6	7.92	10.84	15.59	66.67	0.79	1.59
MS-3420-8	11.10	14.02	18.77	63.50	1.59	1.59
MS-3420-10	14.27	15.62	21.94	60.32	1.59	1.59
MS-3420-12	15.87	18.80	26.23	56.20	1.59	1.59
MS-3420-16	19.05	23.54	26.39	53.97	1.59	1.59
MS-3420-20	23.80	31.50	40.41	50.80	1.59	1.59
MS-3420-24	31.75	34.67	46.79	47.62	1.59	1.59

**Other Accessories**

**Plain flat gasket**

For MS and 97B flange mounted receptacles

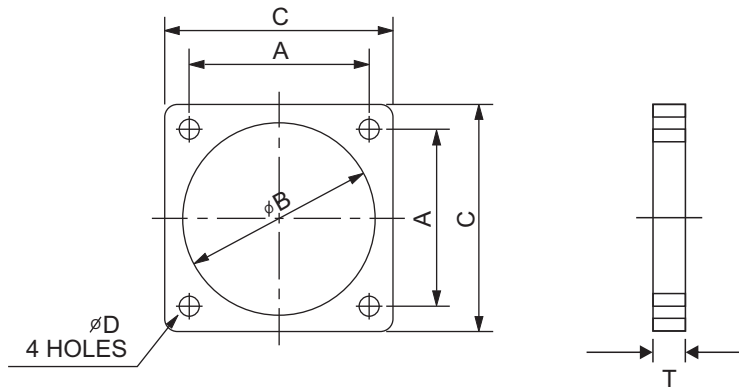

All dimensions are in mm

Part number	Shell size	A max	B	C	D	T
MS-101000	10SL	18.26	15.90	25.40	4.35	1.5
MS-108686	12S & 12	20.62	19.05	27.80	4.35	1.5
MS-101001	14S & 14	23.01	22.20	30.15	4.35	1.5
MS-101002	16S & 16	24.61	25.40	32.50	4.35	1.5
MS-101003	18	27.00	28.57	34.90	5.15	1.5
MS-101004	20	29.36	31.75	38.10	5.15	1.5
MS-101005	22	31.75	34.90	41.20	5.15	1.5
MS-108687	24	34.90	38.10	44.45	5.15	1.5
MS-101006	28	39.70	44.45	50.80	5.15	1.5
MS-108688	32	44.45	50.80	57.15	5.55	1.5
MS-101007	36	49.22	55.57	63.50	5.55	1.5
MS-110831	40	55.77	61.92	69.85	5.55	1.5



**Protective Cap For MS Series  
MS-25043**

**For receptacles** Has internal threads and is used on all receptacles. Gasket is provided in the dust cap forming a watertight seal.

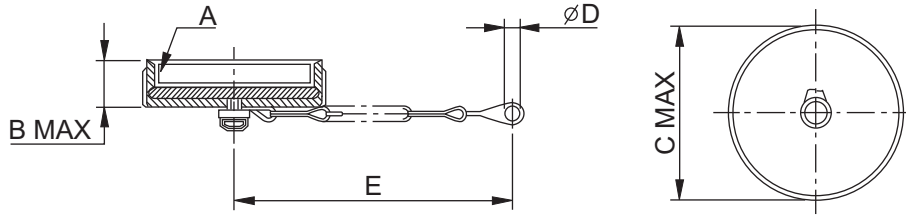

All dimensions are in mm

MS Part number	Shell size	A Thread in inches	B	C	D	E
MS 25043-10D	MS 10S-1-SL	5/8-24	11.11	20.7	3.6	102
MS 25043-12D	MS 12-12S	3/4- 20	11.11	25.4	3.6	115
MS 25043-14D	MS 14-14S	7/8-20	11.11	28.6	3.6	115
MS 25043-16D	MS 16-16S	1-20	11.11	30.2	3.6	115
MS 25043-18D	MS 18	1 1/8-18	11.11	34.1	3.6	115
MS 25043-20D	MS 20	1 1/4-18	11.11	37.3	4.4	127
MS 25043-22D	MS 22	1 3/8-18	11.11	40.4	4.4	127
MS 25043-24D	MS 24	1 1/2-18	11.11	43.6	4.4	140
MS 25043-28D	MS 28	1 3/4-18	12.7	50	4.4	197
MS 25043-32D	MS 32	2-18	12.7	56.3	4.8	197
MS 25043-36D	MS 36	2 1/4-18	12.7	62.7	4.8	197
MS 25043-40D	MS 40	2 1/2-16	12.7	69	4.8	197

- Notes :**
1. For protective caps with nylon cord, contact factory.
  2. Standard - Plating is Cad. For alternative finishes, contact factory.
  3. Standard - straight knurling. For diamond knurling on caps, contact factory.
  4. Please add 07 suffix for bigger end link.

**Other Accessories  
Protective cap for MS series  
MS-25042**

**For plugs** Has external threads and is used on all plugs where a coupling ring is provided.

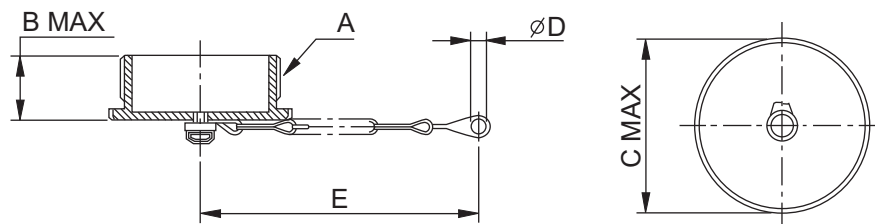

All dimensions are in mm

MS Part number	Shell size	A Thread in inches	B	C	D	E
MS 25042-10D	MS 10S-1-SL	5/8-24	16.67	17.4	4	102
MS 25042-12D	MS 12-12S	3/4- 20	21.4	20.6	4	115
MS 25042-14D	MS 14-14S	7/8-20	21.4	23.7	4	115
MS 25042-16D	MS 16-16S	1-20	21.4	26.9	4	115
MS 25042-18D	MS 18	1 1/8-18	21.4	30	4	115
MS 25042-20D	MS 20	1 1/4-18	21.4	33	4.8	127
MS 25042-22D	MS 22	1 3/8-18	21.4	36.4	4.8	127
MS 25042-24D	MS 24	1 1/2-18	21.4	39.6	4.8	140
MS 25042-28D	MS 28	1 3/4-18	21.4	46	4.8	197
MS 25042-32D	MS 32	2-18	21.4	52	5.6	197
MS 25042-36D	MS 36	2 1/4-18	21.4	58.7	5.6	197
MS 25042-40D	MS 40	2 1/2-16	21.4	65	5.6	197

**Other Accessories**  
**Protective cap for 97B series**  
**97B-25042**  
**For Plugs**

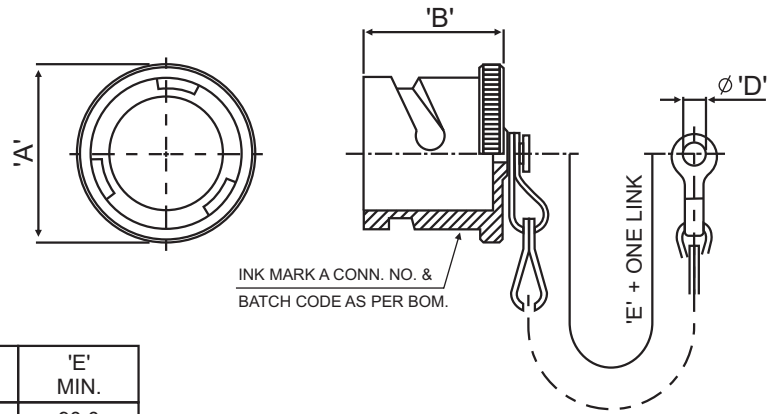

All dimensions are in mm

SHELL SIZE	'A' MAX.	'B' MAX.	'D' + 0.60/-0	'E' MIN.
10 SL	21.0	23.50	4.30	90.0
14 S	27.50			100.0
16 S	30.0	31.50	4.70	115.0
16				130.0
18	33.50			190.0
20	37.0			
22	40.0			
24	43.0	5.50	190.0	
28	49.50			
32	56.0			
36	62.50			
40	73.0			

**Protective cap For 97B series**  
**97B-25043**  
**For Receptacle**

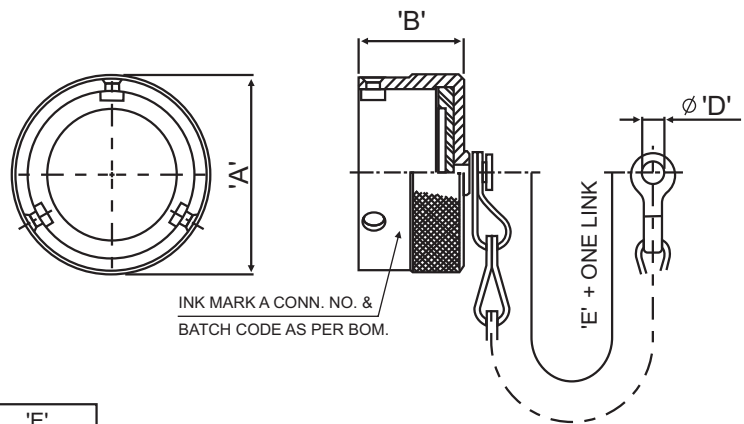

All dimensions are in mm

SHELL SIZE	'A' MAX.	'B' ± 0.20	'D' + 0.60/-0	'E' MIN.
10 SL	23.0	16.0	4.30	90.0
14 S	30.0			100.0
16 S	32.50	20.70	4.70	115.0
16				130.0
18	37.0			160.0
20	40.50			
22	43.50			
24	47.0	5.50	160.0	
28	54.0			
32	60.50			
36	67.0			
40	73.0			

Note :- Please add 07 suffix for bigger end link. Applicable for Jam Nut

## Other Accessories

### Dummy receptacle

#### MS-3105

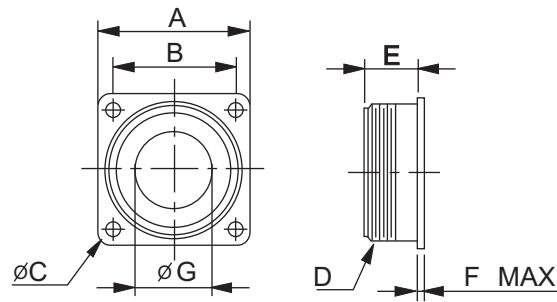

All dimensions are in mm

Part number (see note)	A	B	C	D Thread in inches	E	F max.	G
MS-3105-10S	25.4	18.26	3.05	5/8-24	14.27	3.96	8.20
MS-3105-12S	27.79	20.62	3.05	3/4-20	14.27	3.96	11.43
MS-3105-12	27.79	20.62	3.05	3/4-20	19.05	3.96	11.43
MS-3105-14S	30.17	23.01	3.05	7/8-20	14.27	3.96	13.36
MS-3105-14	30.17	23.01	3.05	7/8-20	19.05	3.96	13.36
MS-3105-16S	32.54	24.61	3.05	1-20	14.27	3.96	16.41
MS-3105-16	32.54	24.61	3.05	1-20	19.05	3.96	16.41
MS-3105-18	34.92	26.97	3.05	1 1/8-18	19.05	5.16	18.03
MS-3105-20	38.10	29.36	3.05	1 1/4-18	19.05	5.16	23.54
MS-3105-22	41.27	31.75	3.05	1 3/8-18	19.05	5.16	25.93
MS-3105-24	44.45	34.92	3.73	1 1/2-18	20.62	5.16	29.21
MS-3105-28	50.8	39.67	3.73	1 3/4-18	20.62	5.16	34.67
MS-3105-36	63.5	49.22	4.39	2 1/4-16	22.2	9.11	46.56

Note: The dash number also indicates shell size.

## Special Accessories

For special accessories, please contact factory with specifications and drawings. Amphenol has in-house capability to meet and custom build your special accessories requirements for its range of MIL-C5015 MS and 97B series connectors.

## MS/97B Connector- Accessories

### Crimp contact

Contacts for MS/97B connectors are machined from copper alloys and silver plated for maximum corrosion resistance, with a minimum millivolt drop and a maximum current carrying capacity; the size 16 and 12 socket contacts are of the closed entry design. Gold plated contacts are also available.

Part Number For Crimp Contacts only*	Pin/ Socket	Mating End Size	Wire Barrel Size	Allowable Wire size	Test Current*** Amps	Insertion/Removal Tool
MS-106433 MS-108456	Pin Socket	16 Short†	16	16 18 60 22**	13 10 7.5 5	97B-IR-16
MS-108295 MS-108457	Pin Socket	16 Long	16	16 18 20 22**	13 10 7.5 5	97B-IR-16
MS-108388 MS-110262	Pin Socket	12	12	12 14	23 17	97B-IR-12
MS-108386 MS-108387	Pin Socket	8	8	8 10**	46 33	97B-IR-8
MS-108384 MS-111878	Pin Socket	4	4	4 6**	80 60	97B-IR-4
MS-112067 MS-112068	Pin Socket	0	0	0 1 2**	150 125	97B-IR-0

\* Solder contacts are not sold as separate items. Part numbers shown here are for crimp contacts only.

\*\* When using wire adapter sleeve shown.

\*\*\* Contact rating as stated are test ratings only. The connector may not withstand full rated current through all contacts continuously. Please note that the electrical data given is not an establishment of electrical safety factors. This is left entirely in the designer's hands as he can best determine which peak voltage, switching surges, transients, etc. can be expected in a particular circuit.

## MS/97B Connectors

### Application tools

When proprietary crimp contacts are employed rather than the standard MS approved solder contacts, the following application tools are recommended for use. There is a possibility of additional crimping tools other than those included being available at present or in the future for this specific application.

#### TOOLING CHART

Crimping Tool	Positioner/ Turret
M22520/1-01	*
M22520/1-01	*
**	**
**	**
**	**

\* Use Daniels Turret TH29-1 or Astro Tool Co. Turret 616266

\*\* For appropriate crimp tool and positioner refer to Pico Crimping Tool Co.

† Tools used with Arbor Press 11-7364

## MS/97B Series Connectors

To obtain the specific connector required, write down the connector number from the typical example below. Only inserts shown in the availability chart shown on page 7 can be specified. Connectors are delivered with protective plastic dust covers. Include premating contact designation only if premating contact is required. The second letter in the premating contact designation stands for the actual contact position. **B** at the end of the connector number indicates telescopic bushing provided.

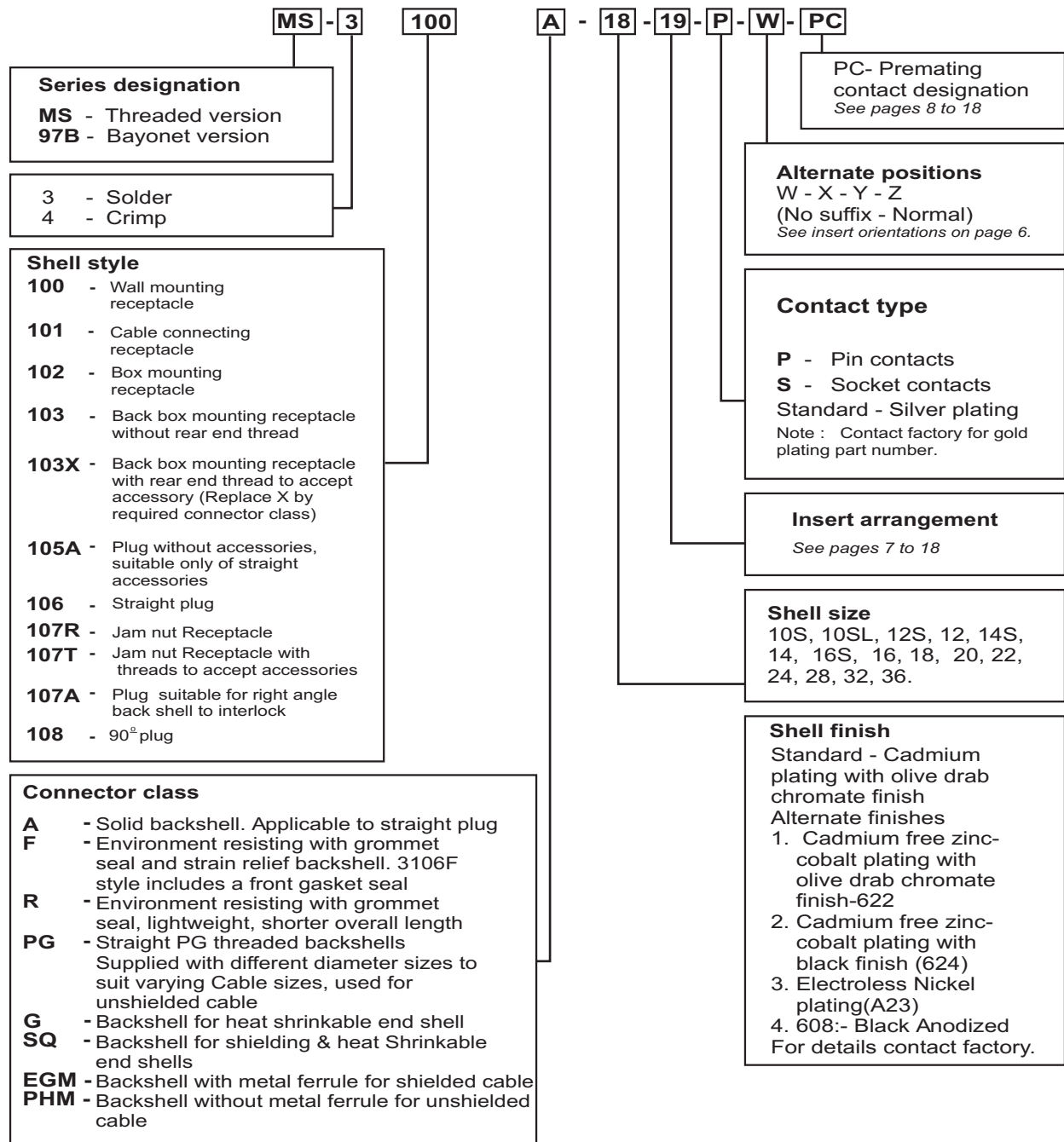

### For 97B - Connector Modification

- F 42 - Less grommet & backshell
- F0/LC - Less contacts
- 563 - Gold plated contacts
- T 00 - Metric threads in flange holes
- 97 BS - Bayonet Version with Steel wear pin (for receptacle connector)
- RFI - Plug connector with grounding finger
- HD - Heavy duty coupling ring

Note:- Connector 3103 supplied in two types. Connector with rear end thread to accept backshell & without rear end thread. To order 3103 without rear end thread do not add any connector class such as(A,E,F,R...) & hence it is similar to 3102 with Back Box mount  
Fore.g 97B-3103-18-1P-622      Connector without thread

**Notes :**

Notice : All information, including illustrations given herein is believed to be accurate at the time of printing. In lieu of design advances, Amphenol reserves the right to change specifications without notice. This publication ACR11 0601 01/10 MS AND 97B Series Connectors supercedes all existing Amphenol literature on MS AND 97 B Series Connectors.



# Amphenol

*A Global Company*



Pune Operations



Bangalore Operations

# Amphenol

Interconnect India Pvt. Ltd.

## Our offices in India:

### MARKETING HEAD QUARTERS

105, Bhosari Industrial Area,  
Pune - 411 026.  
Tel.: 91- 020 - 30688303, 30688304  
Fax : 91 - 020 - 30688321  
Email : vbhavsar@amphenol-in.com  
sales@amphenol-in.com

### Southern Region

4931, 11th Floor, High Point IV  
45, Palace Road, Bangalore 560 001.  
Tel.: 91-80-22281392, 22281002  
Fax : 91-80-22253859  
Email : kmanoj@amphenol-in.com

### Northern and Eastern Region

1414, 14th Floor, Chiranjiv Tower,  
43, Nehru Place, New Delhi - 110 019.  
Tel. : 91-11-26449177  
Telefax : 91-11-26449176  
Email : sunily@amphenol-in.com

### Export

105, Bhosari Industrial Area,  
Pune - 411 026, India.  
Tel.: 91- 20 - 30688305, 30688334  
Fax : 91- 20 - 27129158  
Email : svpatil@amphenol-in.com

### Western Region

105, Bhosari Industrial Area,  
Pune - 411 026.  
Tel.: 91- 20 - 27119735, 30688334  
Fax: 91- 20 - 27120581, 27119735  
Email : sunilp@amphenol-in.com

### Central Region

107, 1st Floor, 'Am Sri Classic',  
Sarojinidevi Road, Secunderabad-500 003.  
Telefax : 91- 40-66332906  
Email : pprasad@amphenol-in.com

[www.amphenol-in.com](http://www.amphenol-in.com)