



FEATURES

- Input Voltage : 2.6V to 5.5V
- Adjustable Output Voltage Range up to 27V
- 1.2MHz Fixed Switching Frequency
- Internal Soft-Start Function
- Current Limit and Thermal Shutdown Protection
- Under Voltage Lockout
- ≤ 1µA Shutdown Current
- Available in the TSOT-23-5L Package

DESCRIPTION

The APE1913 is a current mode step up converter intended for small, low power applications. The converter input voltage ranging from 2.6V to 5.5V. The Output voltage can be set up to 27V. The frequency is 1.2MHz allows the use of small external inductors and capacitors and provides fast transient response. Internal soft start results in small inrush current and extends battery life. Internal power MOSFET with very low RDS (ON) provides high efficiency. The APE1913 automatically transits from PWM to PFM during light load condition further increasing efficiency. The converter also provides protection functions such as under-voltage lockout, current limit and thermal shutdown. The APE1913 is available in TSOT-23-5L package.

TYPICAL APPLICATION

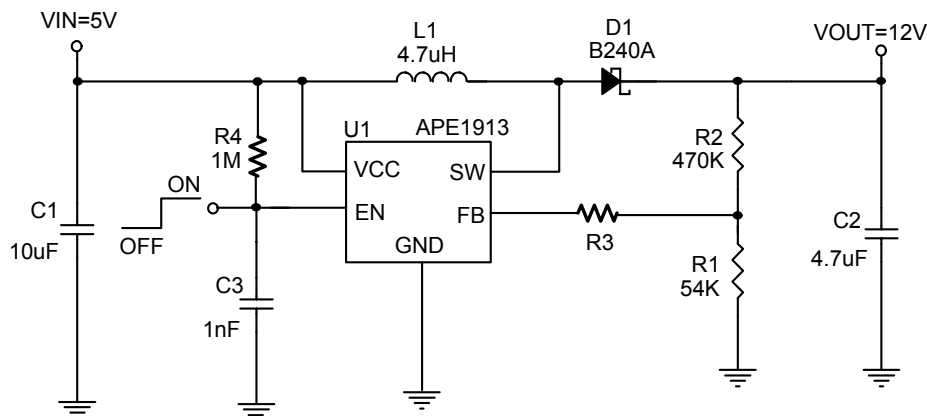

$$VOUT = 1.238V \times \left(1 + \frac{R2}{R1}\right)$$

R2 Suggest 390K~820K

VIN	VOUT	R3
2.6~3.6V	5V	120KΩ
2.6~5.3V	7V	82KΩ
2.6~5.5V	7.5~27V	0Ω

PACKAGE & ORDERING INFORMATION

APE1913X

Package Type
TY5 : TSOT-23-5L

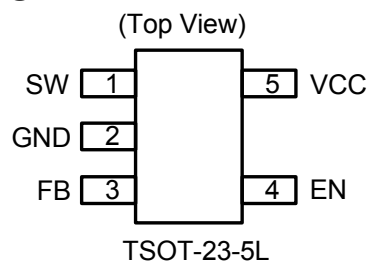



ABSOLUTE MAXIMUM RATINGS

VCC Pin Voltage (V_{CC})	GND - 0.3V to GND + 6.5V
Feedback Pin Voltage (V_{FB})	GND - 0.3 to VCC + 0.3
EN Pin Voltage (V_{EN})	GND - 0.3 to VCC + 0.3
Switch Pin Voltage (V_{SW})	30V
Power Dissipation (PD)	$(T_J - T_A) / R_{thja}$ W
Storage Temperature Range (T_{ST})	-40°C to +150°C
Operating Junction Temperature Range (T_{OP})	-40°C to +125°C
Thermal Resistance from Junction to Case (R_{thJC})	110°C/W
Thermal Resistance from Junction to Ambient (R_{thJA})	250°C/W

Note. R_{thja} is measured with the PCB copper area of approximately 1 in²(Multi-layer).

ELECTRICAL SPECIFICATIONS

($V_{CC}=5V$, $V_{OUT}=12V$, $T_A=25^\circ C$, unless otherwise specified)

Parameter	SYM	TEST CONDITION	MIN	TYP	MAX	UNITS
Input Voltage Range	V_{CC}		2.6	-	5.5	V
Under Voltage Lockout	UVLO	Rising	-	2.35	2.6	V
UVLO Hysteresis			-	-130	-	mV
Step-Up Voltage Adjust Range	V_{OUT}		3	-	27	V
Operating Quiescent Current	I_{CCQ}	$I_{OUT}=0mA$, $V_{FB}=1.5V$	-	150	250	μA
Shutdown Current	I_{SD}	$V_{EN}=0V$	-	0.1	1	μA
Feedback Voltage	V_{FB}		1.213	1.238	1.263	V
FB Input Leakage Current	I_{FB-LKG}	$V_{FB}=1.3V$	-100	0.01	100	nA
Line Regulation		$V_{IN}=2.5$ to $5.5V$, $I_{OUT}=20mA$	-	0.2	-	%
Load Regulation		$V_{IN}=5V$, $I_{OUT}=1mA$ to $400mA$	-	0.2	-	%
Switching Frequency	F_{OSC}		900	1200	1500	KHz
Maximum Duty	D_{MAX}		82	87	-	%
N-channel MOSFET Current Limit	I_{LIM}	Duty=50%	-	1.9	-	A
MOSFET On-resistance (Note1)	$R_{DS(on)}$	$V_{CC}=3V$, $I_{SW}=1A$	-	650	-	$m\Omega$
		$V_{CC}=5V$, $I_{SW}=1A$	-	500	-	
SW Leakage Current	I_{SWL}	$V_{LX}=27V$, $V_{FB}=1.5V$	-	-	1	μA
EN High-level Input Voltage	V_{IH}		1	-	-	V
EN Low-level Input Voltage	V_{IL}		-	-	0.4	V
EN Hysteresis	Hys		-	200	-	mV
EN Input Leakage Current	I_{EN-LKG}	$V_{EN}=GND$ or V_{CC}	-	0.01	0.1	μA
Thermal Shutdown	T_{DS}		-	150	-	°C
Thermal Shutdown Hysteresis	T_{SH}		-	35	-	

Note1: Guaranteed by design.



PIN DESCRIPTIONS

PIN SYMBOL	PIN DESCRIPTION
VCC	Input Supply Pin. Must be locally bypassed.
SW	Power Switch Output. SW is the drain of the internal MOSFET switch. Connect the power inductor and output rectifier to SW. SW can swing between GND and 27V.
FB	Feedback Input. FB voltage is 1.238V. Connect a resistor divider to FB.
EN	Regulator On/Off Control Input. A high input at EN turns on the converter, and a low input turns it off. When not used, connect EN to the input source for automatic startup. The EN pin cannot be left floating.
GND	Ground pin

BLOCK DIAGRAM

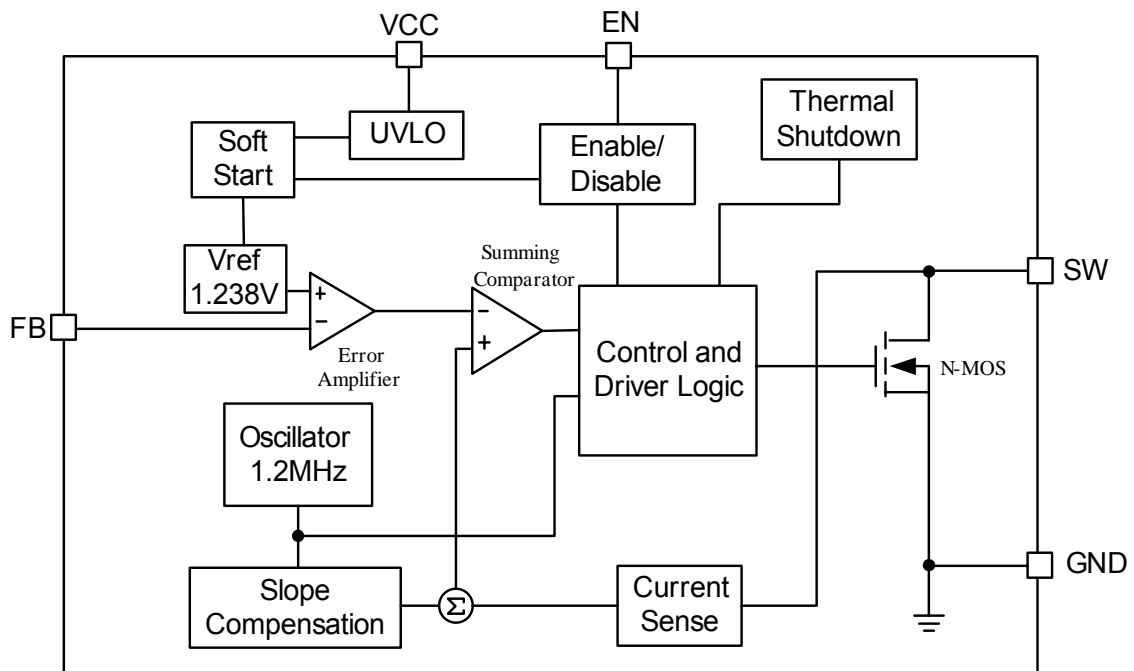



APPLICATION DESCRIPTION

Setting the Output Voltage

Application circuit item shows the basic application circuit with APE1913 adjustable output version. The external resistor sets the output voltage according to the following equation:

$$V_{OUT} = 1.238V \times \left(1 + \frac{R2}{R1}\right)$$

For most applications, R2 is a suggested a value by 390K~820K Ω . Place the resistor-divider as close to the IC as possible to reduce the noise sensitivity.

Under Voltage Lockout (UVLO)

To avoid mis-operation of the device at low input voltages an under voltage lockout is included that disables the device, if the input voltage falls below (2.35V-130mV).

Input Capacitor Selection

The input capacitor reduces the surge current drawn from the input and switching noise from the device. The input capacitor impedance at the switching frequency shall be less than input source impedance to prevent high frequency switching current passing to the input. A low ESR input capacitor sized for maximum RMS current must be used. Ceramic capacitors with X5R or X7R dielectrics are highly recommended because of their low ESR and small temperature coefficients. A 10 μ F ceramic capacitor for most applications is sufficient. For a lower output power requirement application, this value can be decreased.

Output Capacitor Selection

The output capacitor is required to keep the output voltage ripple small and to ensure regulation loop stability. The output capacitor must have low impedance at the switching frequency. Ceramic capacitors with X5R or X7R dielectrics are recommended due to their low ESR and high ripple current. A 4.7 μ F ceramic capacitors works for most of the applications. Higher capacitor values can be used to improve the load transient response.

Layout Guide

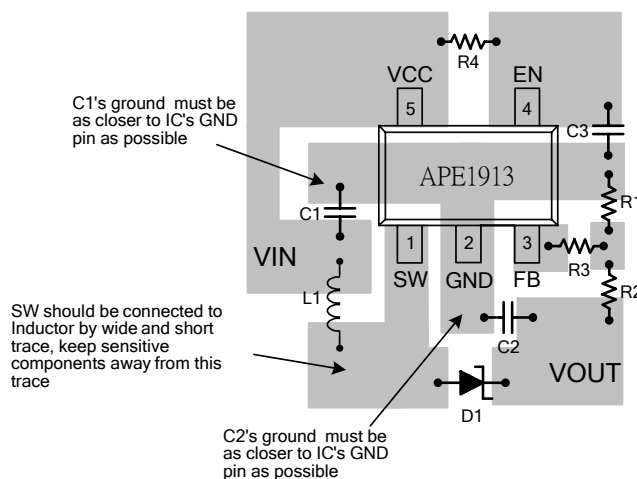



TYPICAL PERFORMANCE CHARACTERISTICS

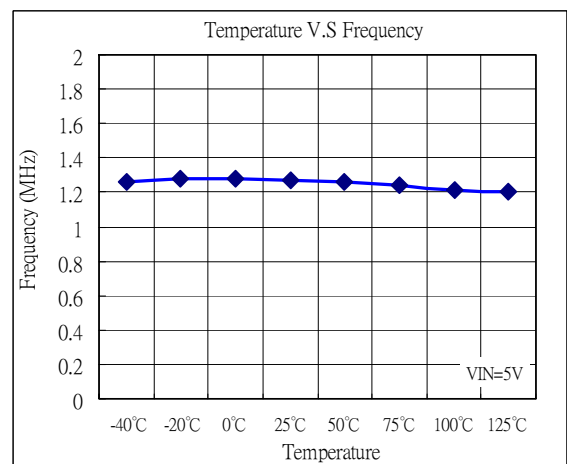
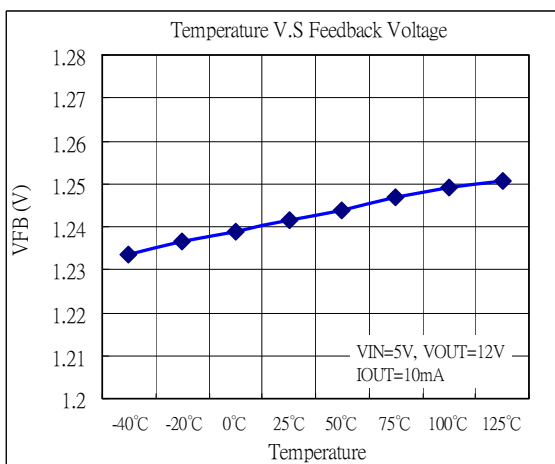
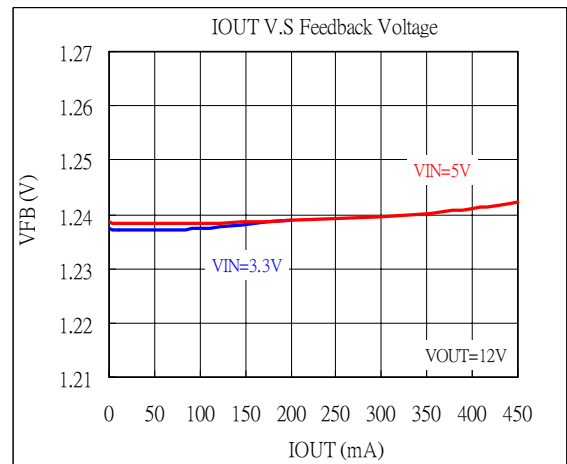
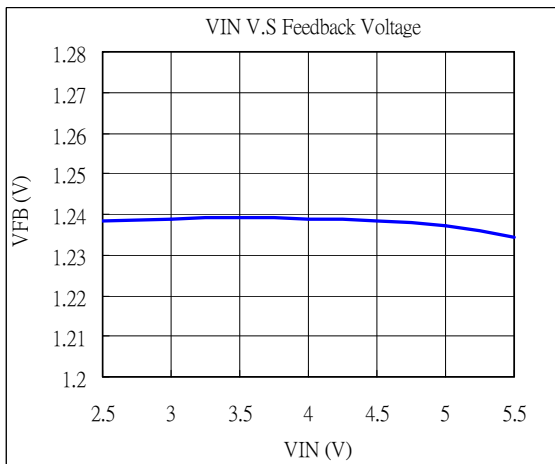
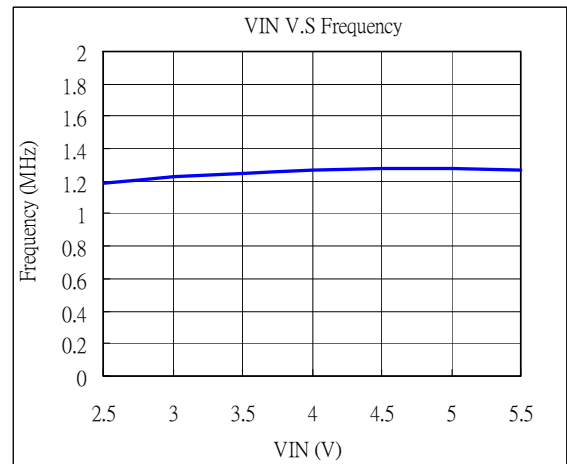
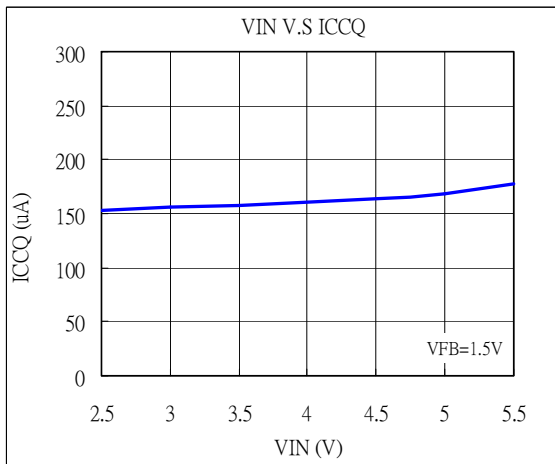



TYPICAL PERFORMANCE CHARACTERISTICS

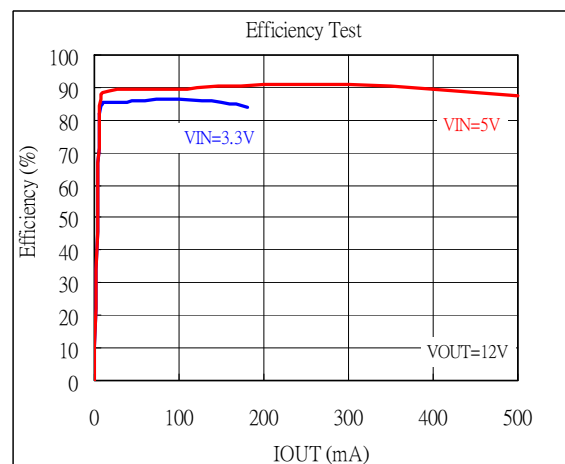
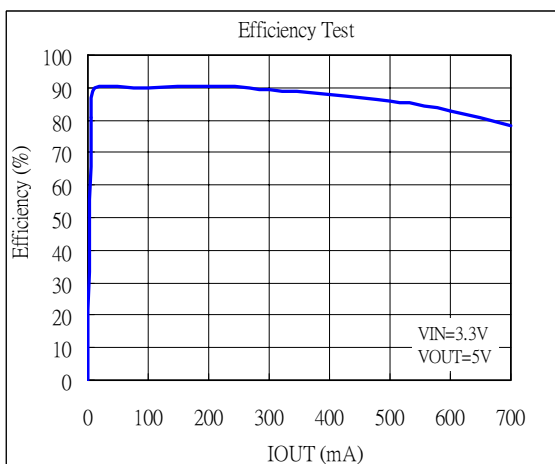
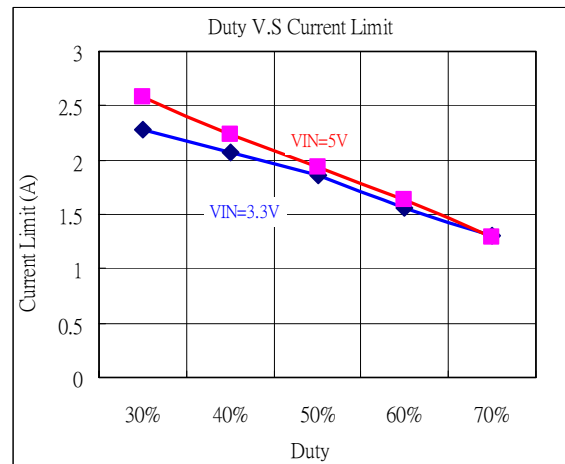
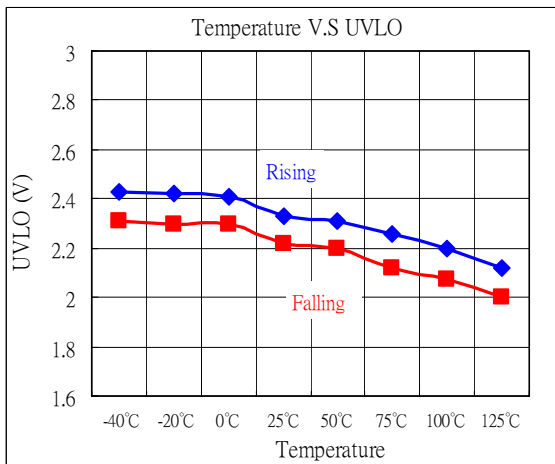
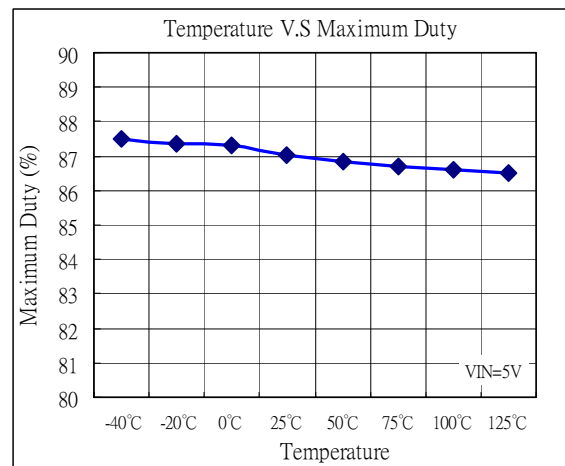
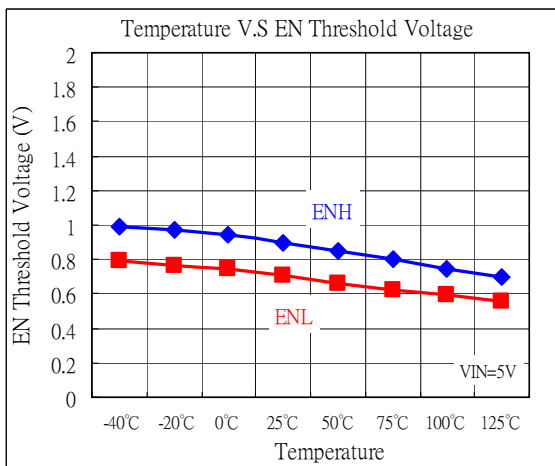



TYPICAL PERFORMANCE CHARACTERISTICS

Load Transient



Load Transient

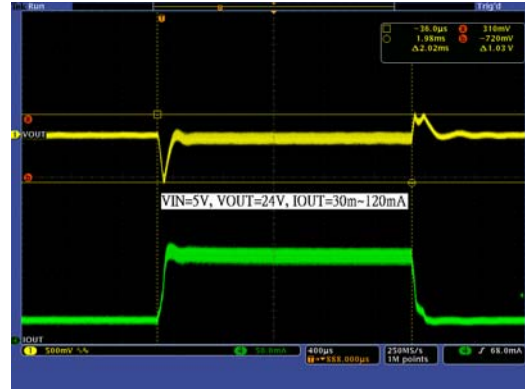

Power ON

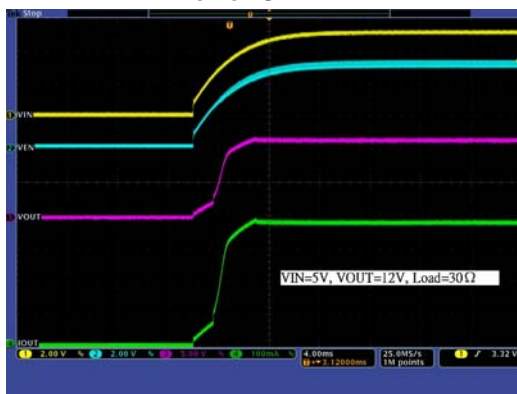

Enable ON



Power ON

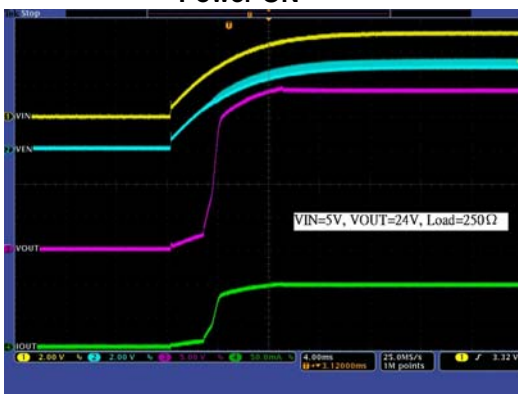

Enable ON

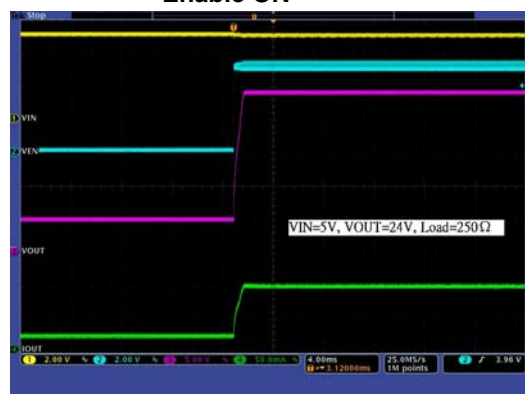



MARKING INFORMATION

TSOT-23-5L

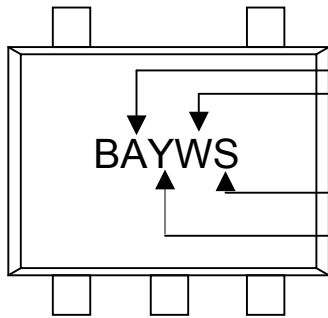

Part Number : BA
Week:
A~Z : 01~26
a~z : 27~52
ID Code : Internal
Year :
A = 2010
1 = 2011
:
:



PACKAGE OUTLINES

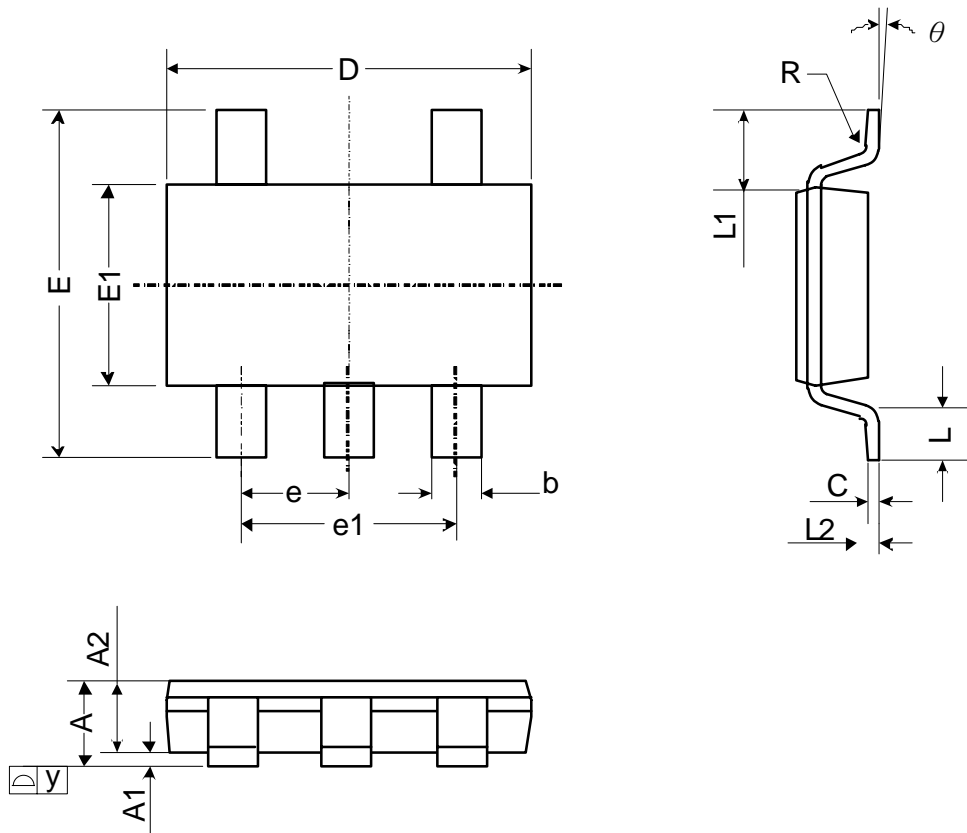

Symbol	Dimensions in Millimeters			Dimensions in Inches		
	Min.	Nom.	Max.	Min.	Nom.	Max.
A	-	-	1.1	-	-	0.043
A1	0	-	0.1	0	-	0.004
A2	0.7	0.9	1	0.028	0.035	0.039
b	0.3	0.4	0.5	0.012	0.016	0.02
C	0.08	0.14	0.2	0.003	0.006	0.008
D	2.8	2.9	3	0.11	0.114	0.118
E	2.6	2.8	3	0.102	0.11	0.118
E1	1.5	1.6	1.7	0.059	0.063	0.067
e	0.95 BSC.			0.037 BSC.		
e1	1.90 BSC.			0.075 BSC.		
L	0.3	0.45	0.6	0.012	0.018	0.024
L1	0.60 REF.			0.024 REF.		
L2	0.25 BSC.			0.010 BSC.		
y	-	-	0.1	-	-	0.004
R	0.1	-	-	0.004	-	-
θ	0°	-	8°	0°	-	8°

JECED outline: MO-193 AB