

**3.3V 400mA/250mA⁺ Low Dropout Regulator****Features**

- Dropout voltage typically 0.8V @ $I_o = 400\text{mA} / 250\text{mA}^+$
- Output current in excess of 400mA / 250mA⁺
- Output voltage accuracy $\pm 2\%$
- Quiescent current, typically 0.6mA
- Internal short circuit current limit
- Internal over temperature protection

General Description

The G910/G911 positive 3.3V voltage regulator features the ability to source 400mA/ 250mA⁺ of output current with a dropout voltage of typically 0.8V. A low quiescent current is provided. The typical quiescent current is 0.6mA.

[⁺ For $\mu\text{TO-92}$ & TO-92 package]

Familiar regulator features such as over temperature and over current protection circuits are provided to prevent it from being damaged by abnormal operating conditions.

Ordering Information

ORDER NUMBER	PACKAGE TYPE	PIN OPTION		
		1	2	3
G910T21U	SOT 89	V_{OUT}	GND	V_{IN}
G911T24U	SOT 89	GND	V_{IN}	V_{OUT}
G910T65U	SOT 223	V_{IN}	GND	V_{OUT}
G910TD1B	TO92	V_{OUT}	GND	V_{IN}
G911TD4B	TO92	GND	V_{IN}	V_{OUT}
G910T81B	μTO92	V_{OUT}	GND	V_{IN}
G911T84B	μTO92	GND	V_{IN}	V_{OUT}
G911T85B	μTO92	V_{IN}	GND	V_{OUT}

* For other package types, pin options and package, please contact us at sales@gmt.com.tw

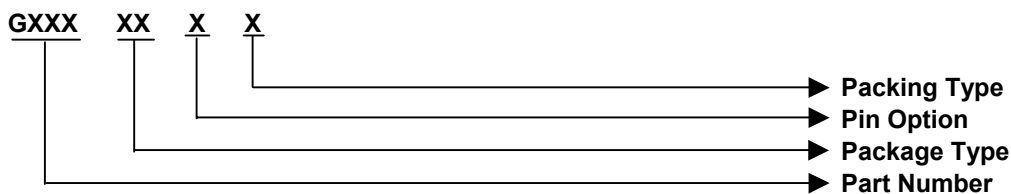
Order Number Identification**PACKAGE TYPE**

T2 : SOT 89
T6 : SOT 223
T7 : SOT 23
T8 : μTO92
TD : TO92

PIN OPTION

	1	2	3
1 :	V_{OUT}	GND	V_{IN}
2 :	V_{OUT}	V_{IN}	GND
3 :	GND	V_{OUT}	V_{IN}
4 :	GND	V_{IN}	V_{OUT}
5 :	V_{IN}	GND	V_{OUT}
6 :	V_{IN}	V_{OUT}	GND

PACKING

U & D : Tape & Reel Direction
T : Tube
B : Bag

Typical Application

[Note 4]: Type of C_{OUT}

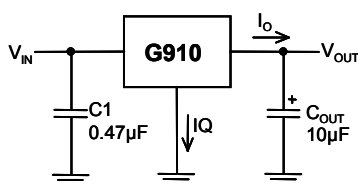
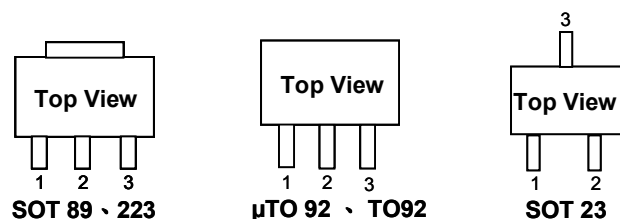
**Package Type**



Absolute Maximum Ratings	(Note 1)
Input Voltage.....	10V
Power Dissipation Internally Limited	(Note2)
Maximum Junction Temperature.....	150°C
Storage Temperature Range.....	-65°C ≤ T _J ≤ +150°C
Lead Temperature, Time for Wave Soldering	
SOT89, SOT223, μTO92 Package.....	260°C, 4s
Continuous Power Dissipation (T _A = + 25°C)	
SOT 89 ⁽¹⁾	0.5W
SOT 223 ⁽¹⁾	0.8W
μTO 92 & TO 92 ⁽¹⁾	0.5W

Note ⁽¹⁾: See Recommended Minimum Footprint.

Operating Conditions	(Note 1)
Input Voltage.....	4V ~ 7V
Temperature Range.....	0°C ≤ T _J ≤ 125°C

Electrical Characteristics

V_{IN} = 5V, I_O = 400mA/250mA+, C_{IN} = 10μF, C_{OUT} = 10μF. All specifications apply for T_A = T_J = 25°C. [Note 3]

PARAMETER	CONDITIONS	MIN	TYP	MAX	UNITS
Output Voltage	5mA ≤ I _O ≤ 400mA	3.234	3.3	3.366	V
	5mA ≤ I _O ≤ 250mA ⁺				
Line Regulation	4V ≤ V _{IN} ≤ 7V, I _O = 10mA		10	30	mV
Load Regulation	10mA ≤ I _O ≤ 400mA		42	60	mV
	10mA ≤ I _O ≤ 250mA ⁺		28	45	
Output Impedance	100mA DC and 100mA AC, f _O = 120Hz		102		mΩ
Quiescent Current	V _{IN} = 5V		0.6		mA
Ripple Rejection	f _i = 120 Hz, 1V _{P-P} , I _O = 100mA		42		dB
Dropout Voltage	I _O = 400mA		0.65		V
	I _O = 250mA ⁺		0.35		
	I _O = 50mA		50	100	mV
Output Current	Continuous Test T _A = 25°C, T _J < 125°C, V _{OUT} within ±2% (Note 2)	V _{IN} = 4.5V, mounted on SOT 89 recommended minimum footprint	400		mA
		V _{IN} = 5.2V, μTO 92 & TO 92 package 0.53 inch leads soldered to PC Board	250 ⁺		
Short Circuit Current			0.77		A
Over Temperature			125		°C

[⁺ for μTO-92 & TO-92 Package]

Note 1: Absolute Maximum Ratings are limits beyond which damage to the device may occur. Operating Conditions are conditions under which the device functions but the specifications might not be guaranteed. For guaranteed specifications and test conditions see the Electrical Characteristics.

Note2: The maximum power dissipation is a function of the maximum junction temperature, T_{Jmax}; total thermal resistance, θ_{JA}, and ambient temperature T_A. The maximum allowable power dissipation at any ambient temperature is T_{Jmax}-T_A/ θ_{JA}. If this dissipation is exceeded, the die temperature will rise above 150°C and IC will go into thermal shutdown. For the G910 in SOT 89 package & μTO 92, TO 92, θ_{JA} is 250°C/W and in the SOT-223 package is 156°C/W (See Recommended Minimum Footprint). The safe operation in SOT 89, μTO 92, TO 92 & SOT 223 package, it can see "Typical Performance Characteristics" (Safe Operating Area).

Note3: Low duty pulse techniques are used during test to maintain junction temperature as close to ambient as possible.

Note4: The type of output capacitor should be tantalum or aluminum.

Definitions

Dropout Voltage

The input/output Voltage differential at which the regulator output no longer maintains regulation against further reductions in input voltage. Measured when the output drops 100mV below its nominal value, dropout voltage is affected by junction temperature, load current and minimum input supply requirements.

Line Regulation

The change in output voltage for a change in input voltage. The measurement is made under conditions of low dissipation or by using pulse techniques such that average chip temperature is not significantly affected.

Load Regulation

The change in output voltage for a change in load current at constant chip temperature. The measurement is made under conditions of low dissipation or by using pulse techniques such that average chip temperature is not significantly affected.

Maximum Power Dissipation

The maximum total device dissipation for which the regulator will operate within specifications.

Quiescent Bias Current

Current which is used to operate the regulator chip and is not delivered to the load.



Typical Performance Characteristics

($V_{IN}=5V$, $C_{IN}=1\mu F$, $C_{OUT}=10\mu F$, $T_A=25^\circ C$, unless otherwise noted.)

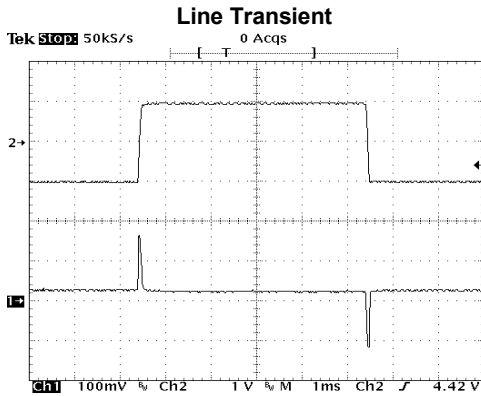

Ch1: Vout (offset=3.30V)
Ch2: Vin (offset=5.0V)
Iout=100mA

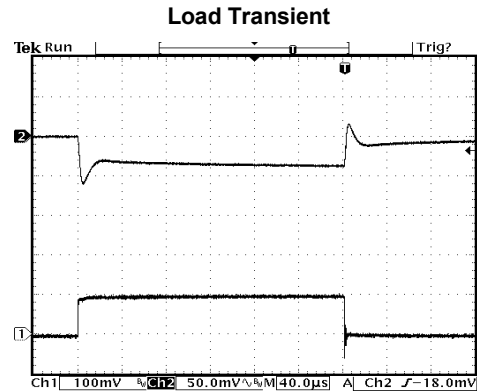

Ch1: Iout (400mA/div)
Ch2: Vout (offset=3.30V)

Output Voltage vs. Load Current

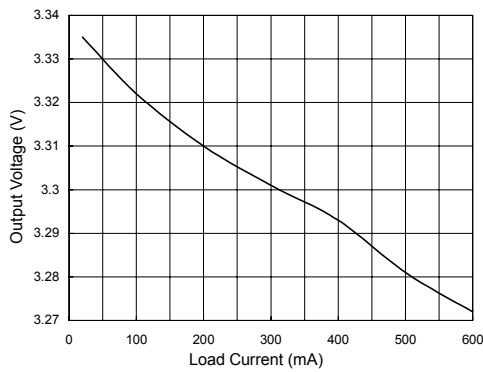

Dropout Voltage vs. Load Current

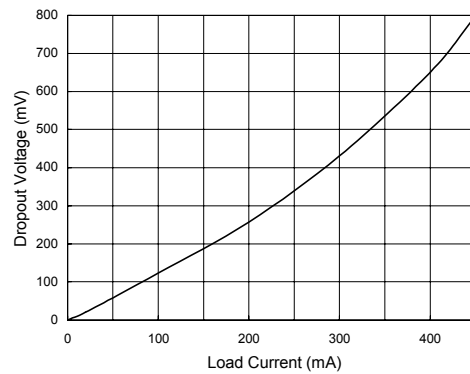

Ground Current vs. Load Current

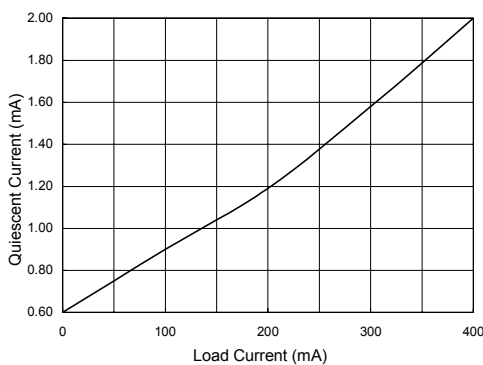



Typical Performance Characteristics

(VIN=5V, CIN=1μF, COUT =10μF, TA=25°C, unless otherwise noted.)

Safe Operating Area of SOT-89

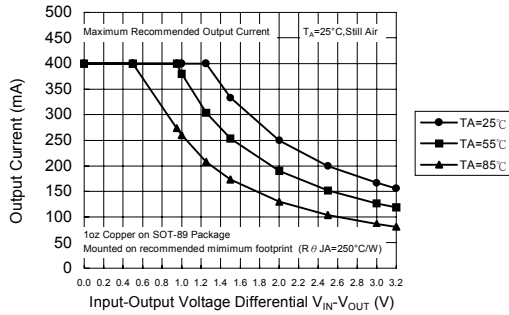

Note: VIN(max) <= 6.5V

Maximum Power Dissipation of SOT-89

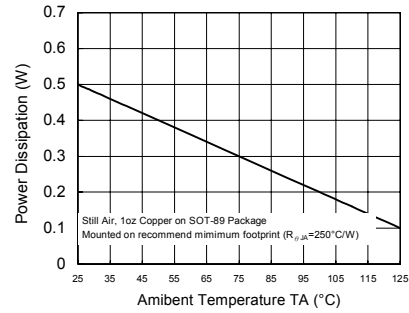

Safe Operating Area of μTO-92 & TO-92

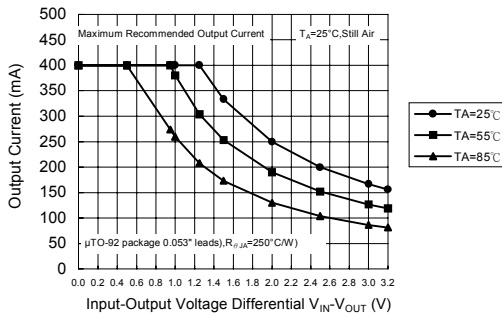

Note: VIN(max) <= 6.5V

Maximum Power Dissipation of μTO-92 & TO-92

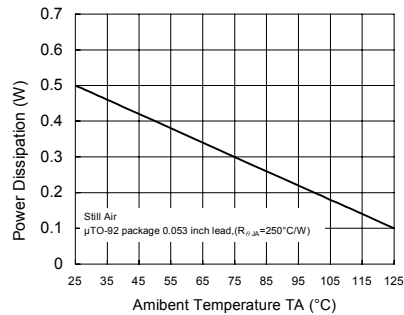

Safe Operating Area of SOT-223

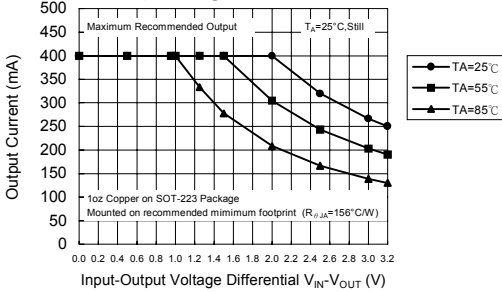

Note: VIN(max) <= 6.5V

Maximum Power Dissipation of SOT-223

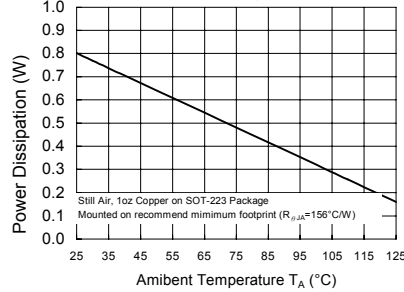

Recommended Minimum Footprint

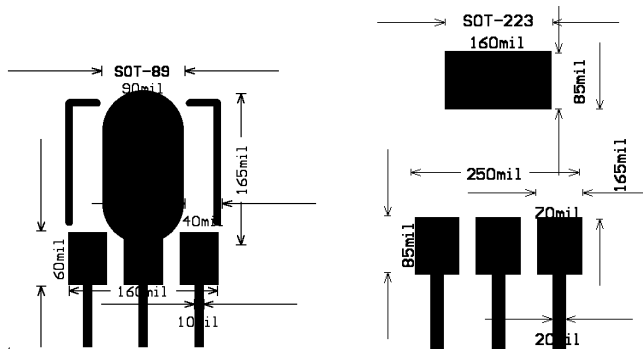



Package Information

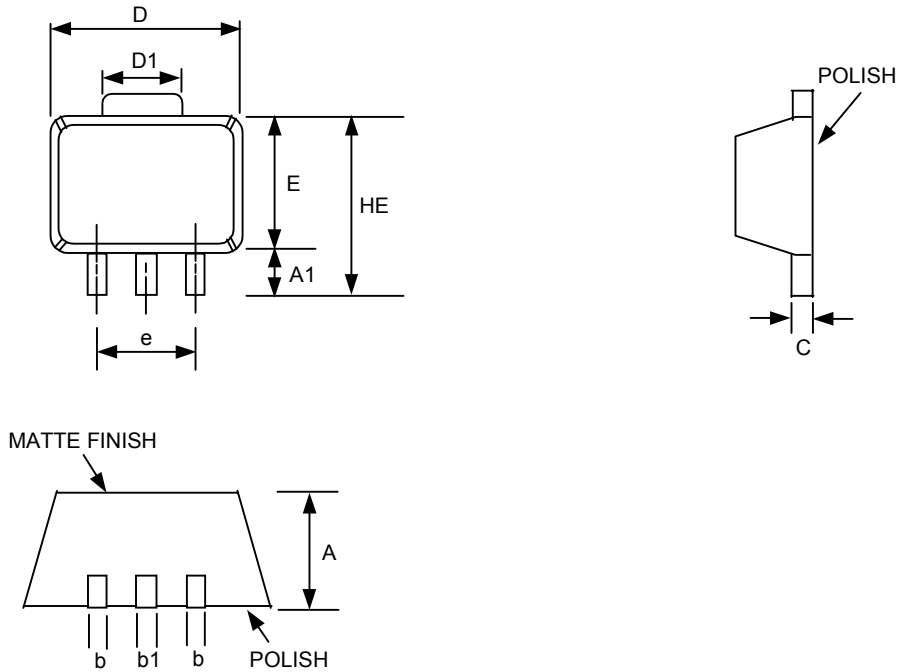

SOT- 89 (T2) Package

SYMBOLS	DIMENSIONS IN MILLIMETERS			DIMENSIONS IN INCHES		
	MIN	NOM	MAX	MIN	NOM	MAX
A	1.40	1.50	1.60	0.055	0.059	0.063
A1	0.80	1.04	-----	0.031	0.041	-----
b	0.36	0.42	0.48	0.014	0.016	0.048
b1	0.41	0.47	0.53	0.016	0.018	0.020
C	0.38	0.40	0.43	0.014	0.015	0.017
D	4.40	4.50	4.60	0.173	0.177	0.181
D1	1.40	1.60	1.75	0.055	0.062	0.069
HE	-----	-----	4.25	-----	-----	0.167
E	2.40	2.50	2.60	0.094	0.098	0.102
e	2.90	3.00	3.10	0.114	0.118	0.122

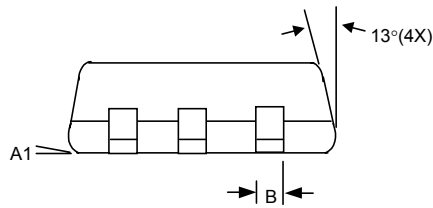
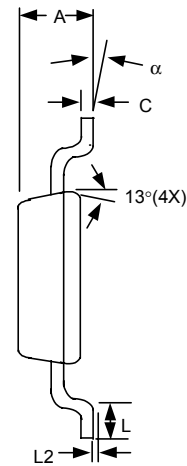
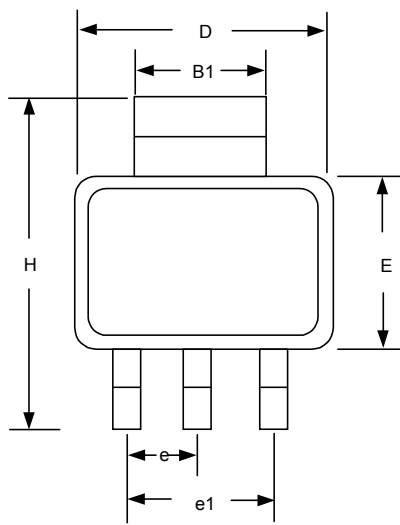

SOT-223 (T6) Package

SYMBOLS	MILLIMETERS		INCHES	
	MIN	MAX	MIN	MAX
A	1.55	1.80	0.061	0.071
A1	0.02	0.12	0.0008	0.0047
B	0.60	0.80	0.024	0.031
B1	2.90	3.10	0.114	0.122
C	0.24	0.32	0.009	0.013
D	6.30	6.70	0.248	0.264
E	3.30	3.70	0.130	0.146
e	2.30 BSC		0.090 BSC	
e1	4.60 BSC		0.181 BSC	
H	6.70	7.30	0.264	0.287
L	0.90 MIN		0.036 MIN	
L2	0.06 BSC		0.0024 BSC	
α	0°	10°	0°	10°

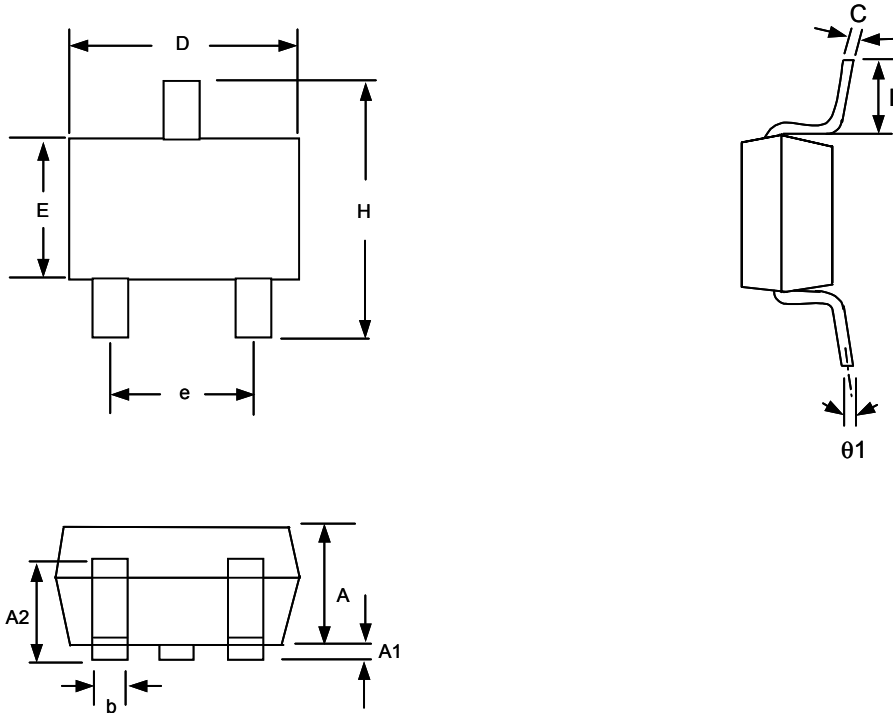

SOT-23 (T7) Package

Note:

- 1.Package body sizes exclude mold flash protrusions or gate burrs
- 2.Tolerance ± 0.1000 mm (4mil) unless otherwise specified
- 3.Coplanarity: 0.1000mm
- 4.Dimension L is measured in gage plane

SYMBOLS	DIMENSIONS IN MILLIMETERS		
	MIN	NOM	MAX
A	1.00	1.10	1.30
A1	0.00	-----	0.10
A2	0.70	0.80	0.90
b	0.35	0.40	0.50
C	0.10	0.15	0.25
D	2.70	2.90	3.10
E	1.40	1.60	1.80
e	-----	1.90(TYP)	-----
H	2.60	2.80	3.00
L	0.37	-----	-----
$\theta 1$	1°	5°	9°

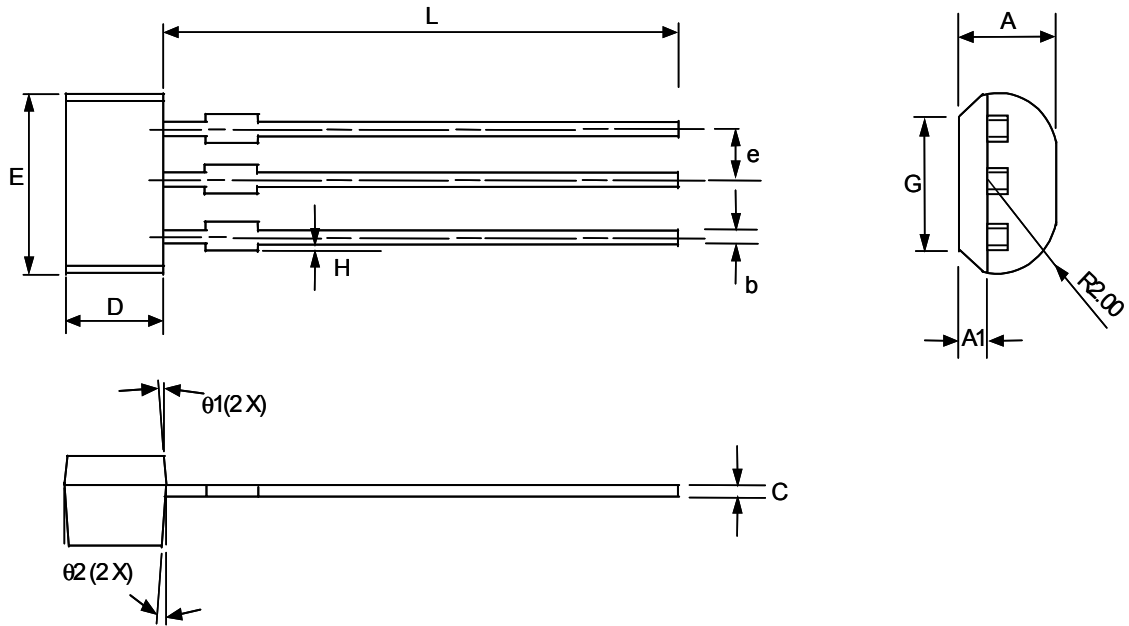

μTO-92 (T8) Package

SYMBOLS	DIMENSIONS IN MILLIMETERS			DIMENSIONS IN INCHES		
	MIN	NOM	MAX	MIN	NOM	MAX
A	2.40	2.50	2.60	0.094	0.098	0.102
A1	0.70	0.80	0.90	0.028	0.032	0.036
b	0.35	0.45	0.55	0.014	0.018	0.022
C	-----	0.40	-----	-----	0.016	-----
D	2.80	3.00	3.20	0.110	0.118	0.126
E	3.80	4.00	4.20	0.149	0.157	0.165
e	-----	1.27	-----	-----	0.050	-----
F	1.91	2.11	2.31	0.075	0.083	0.091
G	3.35	3.55	3.75	0.132	0.140	0.148
H	0.00	-----	0.15	0.000	-----	0.006
L	13.80	14.00	14.20	0.543	0.551	0.559
$\theta 1$	-----	2°	-----	-----	2°	-----
$\theta 2$	-----	5°	-----	-----	5°	-----

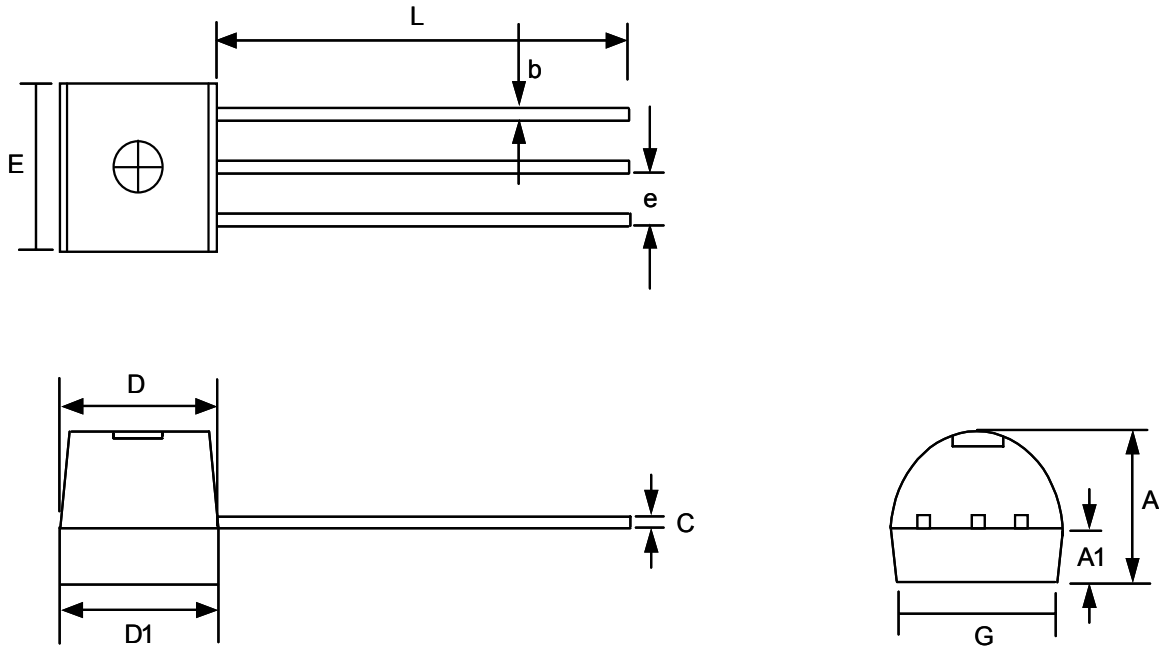

TO-92 (TD) Package

SYMBOLS	MILLIMETERS		INCHES	
	MIN	MAX	MIN	MAX
A	3.35	3.86	0.132	0.152
A1	1.0414	1.55	0.041	0.061
b	0.254	0.508	0.010	0.020
E	4.34	4.85	0.171	0.191
C	0.254	0.508	0.010	0.020
L	14.53	15.04	0.572	0.592
e	1.143	1.397	0.045	0.055
G	3.683	4.191	0.145	0.165
D	4.29	4.80	0.169	0.189
D1	4.34	4.85	0.171	0.191

Package Orientation

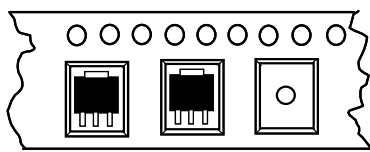

Feed Direction
SOT 89 - 223 Package Orientation

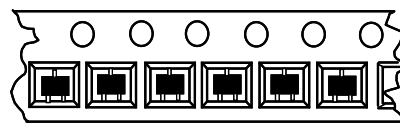

Feed Direction
SOT 23 Package Orientation

GMT Inc. does not assume any responsibility for use of any circuitry described, no circuit patent licenses are implied and GMT Inc. reserves the right at any time without notice to change said circuitry and specifications.