

MGA-23003

3.3-3.8 GHz WiMAX Power Amplifier (3x3mm)



Data Sheet

Description

Avago Technologies MGA-23003 linear power amplifier is designed for mobile and fixed wireless data applications in the 3.3 to 3.8 GHz frequency ranges. The PA is optimized for IEEE 802.16 WiMAX modulation but can be used for any high linearity applications. The PA exhibits flat gain and good match while providing linear power efficiency to meet stringent mask conditions. It utilizes Avago Technologies proprietary GaAs Enhancement-mode pHEMT technology for superior performance across voltage and temperature levels.

The MGA-23003 is packaged in a 3x3x1 mm size for space-constrained applications.

Applications

- Portable WiMAX applications
- WiMAX Access points

Functional Block Diagram

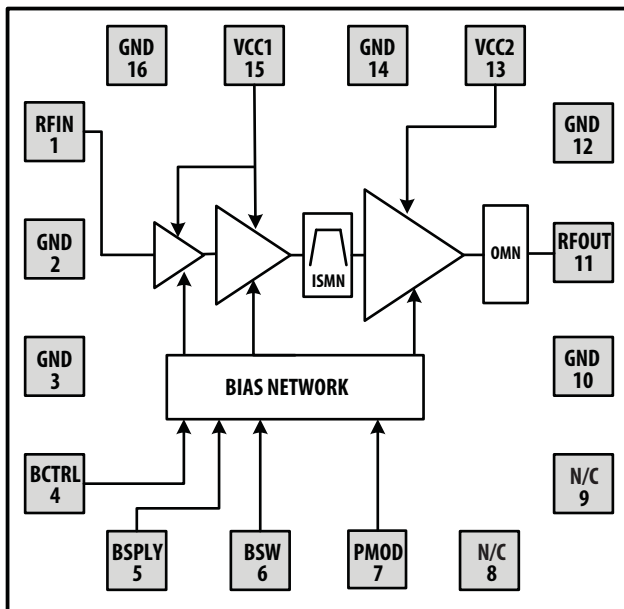

Features

- Advanced GaAs E-pHEMT
- 50 Ω all RF ports
- Full performance across entire 3.3-3.8GHz
- 13dB gain attenuation in low power mode with I_{dsq} reduction
- Integrated CMOS compatible pins for shutdown and low power mode
- 3 to 5V supply
- ESD protection all ports above 1000V HBM
- Small size: 3 x 3 x 1 mm
- Stable under all loads or conditions
- -40°C to +85°C operation
- Integrated DC blocking capacitors for Input and Output pins.

At 3.5GHz (BCTRL = 2.8V)

- Gain of 35dB
- PAE of 18%
- Meets ETSI/802.16 masks at 25 dBm P_{out}, 16QAM WiMAX with 3.3V and 514mA
- 16QAM WiMAX EVM < -31dB (2.8%) at 25dBm
- Low power I_{dd}, 94mA, 25dB gain, 0dBm P_{out}

Device Marking Instruction

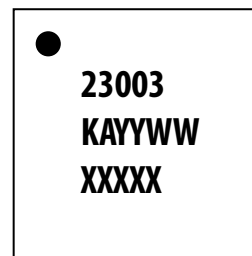

3mm x 3mm x 1mm

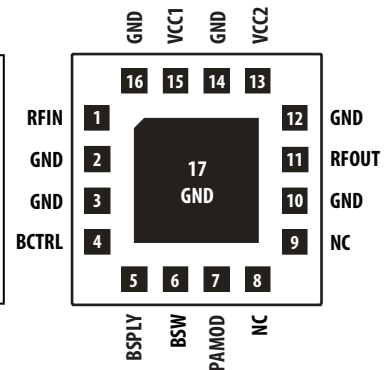

TOP VIEW

"23003" = Product Code

"KA" = Korea ASE

"YY" = Year code indicates the year of manufacture

"WW" = Workweek code indicates the workweek of manufacture

"XXXXX" = Last 5 digit of assembly lot number

Electrical Specifications

Absolute Minimum and Maximum Ratings

Table 1. Minimum and Maximum Ratings

Parameter		Specifications				Comments
Description	Pin	Min.	Typical	Max.	Unit	
Supply Voltage	VCC1 VCC2	3	3.3	5.5	V	
Bias Supply	BSPLY	3	3.3	5.5	V	
Bias Control	BCTRL	1.65	2.8	5.5	V	
Bias ON/OFF	BSW	1.65	1.8	5.5	V	
Mode Control	PAMODE	1.65	1.8	5.5	V	
RF Input Power	RFIN			15	dBm	Using 16QAM
MSL				MSL3		
Channel Temperature				150	°C	
Storage Temperature		-65		150	°C	

Table 2. Recommended Operating Range

Parameter		Specifications				Comments
Description	Pin	Min.	Typical	Max.	Unit	
Supply Voltage	VCC1 VCC2	3	3.3	5	V	
Bias Supply	BSPLY	3	3.3	5	V	
			18		mA	
Bias Control	BCTRL	2.75	2.8	2.85	V	
			1		uA	
Bias ON/OFF	BSW	1.65	1.8	2.2	V	
			36		uA	
Mode Control	PAMODE	1.65	1.8	2.2	V	
			15		uA	
RF Output Power	RFOUT			25	dBm	Using 16QAM
Frequency Range		3.3		3.8	GHz	
Thermal Resistance, θ_{ch-b}			23.4		°C/W	Channel to board
Case Temperature		-40		+85	°C	

WiMAX (802.16e) Electrical Specifications

All data measured on an FR4 demo board at $V_{cc1} = V_{cc2} = 3.3V$, $BCTRL = 2.8V$, $T_c = 25^{\circ}C$, 50Ω at all ports. Unless otherwise specified, all data is taken with OFDM 16-QAM modulated signal per IEEE 802.16e with 10MHz BW operating over the BW of 3.3GHz to 3.8GHz.

Table 3. RF Electrical Characteristics

Parameter	Performance			Unit	Comments	
	Min.	Typical	Max.			
Input Return Loss		-10		dB		
Gain Flatness		1		dB	Over any 10MHz	
Gain Variation (V_{CC})	-1		1	dB	3V to 5V	
High Power Mode	EVM		-30	-27	dB	$V_{CC}=3.3V$
			-32	-28		$V_{CC}=3.6V$
	SEM-A @5.05MHz		-54	-32	dBm/100kHz	IBW=100kHz
	SEM-B @7.1MHz		-46	-37	dBm/MHz	IBW=1MHz
	SEM-C @10.6MHz		-51	-41		
	SEM-D @20MHz		-66	-60		
	SEM-E @25MHz		-68	-60		
	Pout (SEM Compliant)	+25			dBm	ETSI EN 302 623 and ETSI EN 302 326-2 (3.3-3.8GHz)
Total DC Current		520	600	mA	Pout=25dBm	
		490			Pout=24dBm	
Gain	32	34	38	dB		
Low Power Mode	EVM		-30		dB	Pout=0dBm 3.4-3.8GHz
	Gain Step	10	13	15	dB	
	Total DC Current		94		mA	Pout=0dBm
P1dB		31		dBm	CW Single Tone	
Psat		32		dBm	CW Single Tone	
2fo		-12	-10	dBm/MHz	3.3-3.8GHz	
3fo		-43	-37	dBm/MHz		
Settling Time	0.2	0.5		uS		
Icc leakage current		10	40	uA		
Noise Power in Cell Band		-143		dBm/Hz		
Noise Power in GPS Band		-142		dBm/Hz		
Noise Power in PCS Band		-140		dBm/Hz		
Noise Power in 2.4GHz WiFi		-138		dBm/Hz		

Selected performance plots

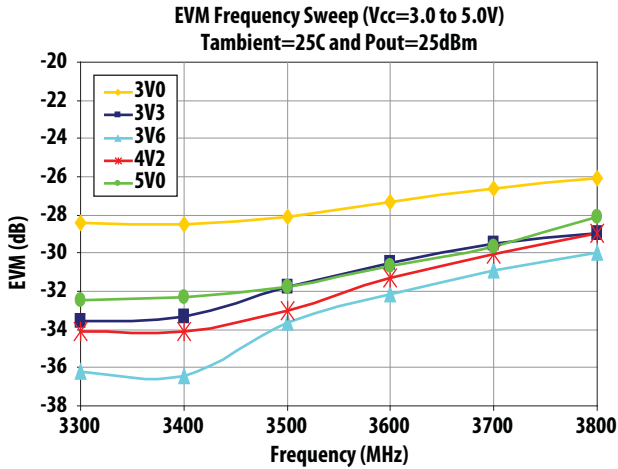

Figure 1. EVM Frequency Sweep at 25C and Pout=25dBm over Vcc

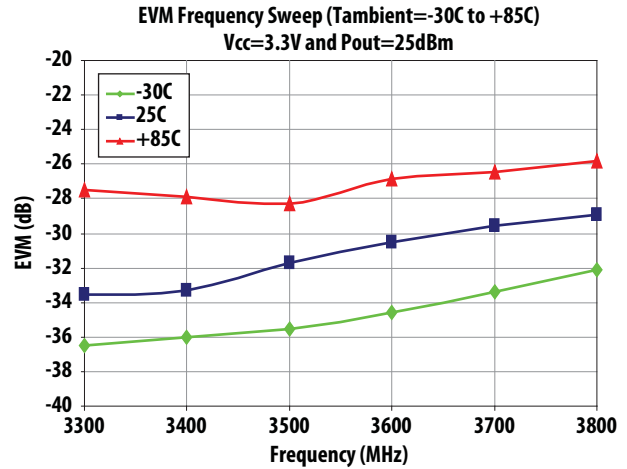

Figure 2. EVM Frequency Sweep at 25C and Pout=26dBm over Vcc

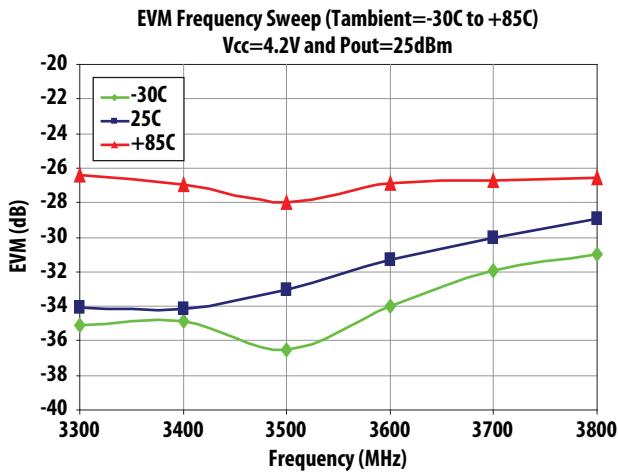

Figure 3. EVM Frequency Sweep at Vcc=3.3V and Pout=25dBm over Tambient

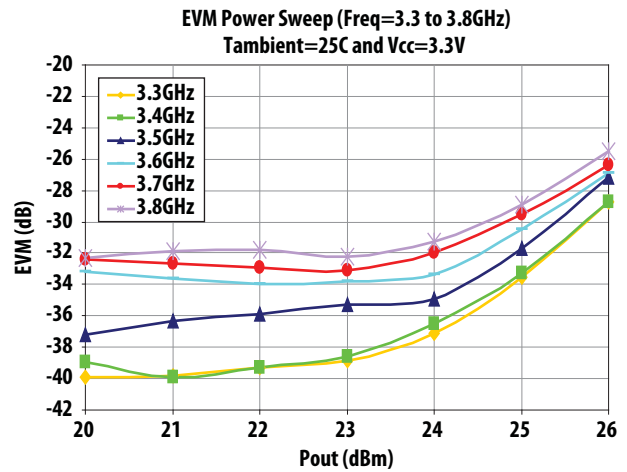

Figure 4. EVM Power Sweep at Vcc=3.3V and 25C over Frequency

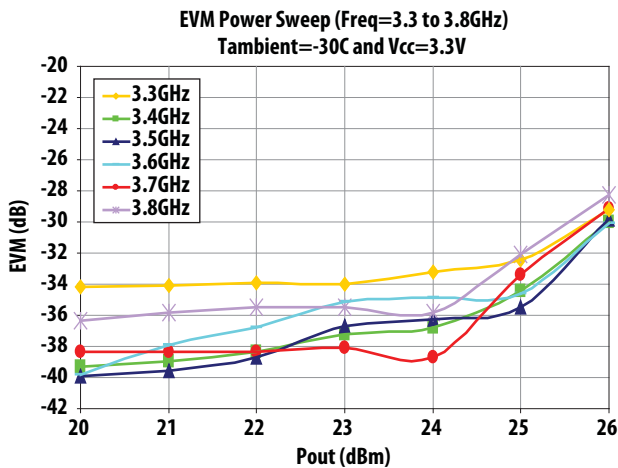

Figure 5. EVM Power Sweep at Vcc=3.3V and -30C over Frequency

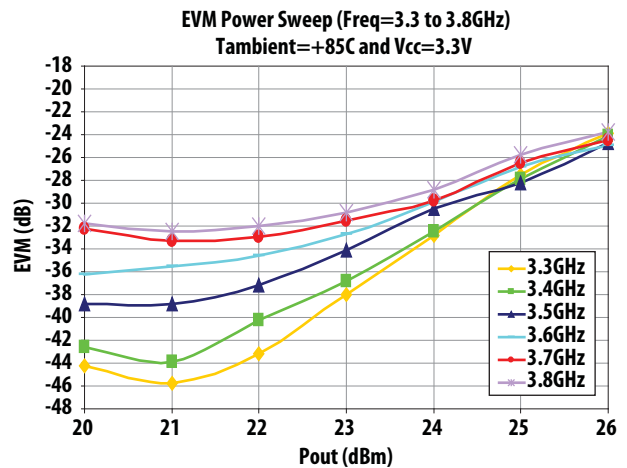

Figure 6. EVM Power Sweep at Vcc=3.3V and +85C over Frequency

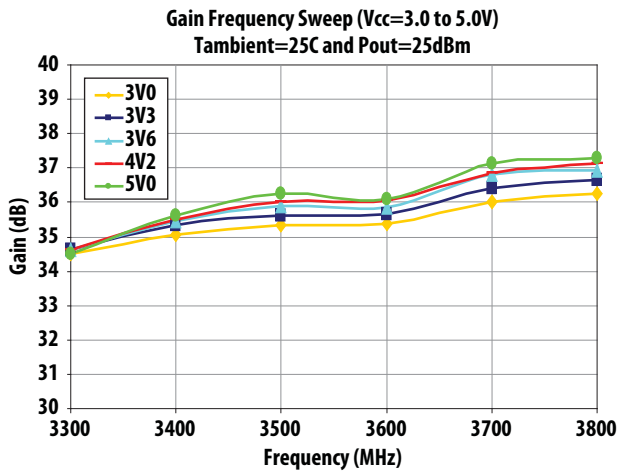

Figure 7. Gain Frequency Sweep at 25C and Pout=25dBm over Vcc

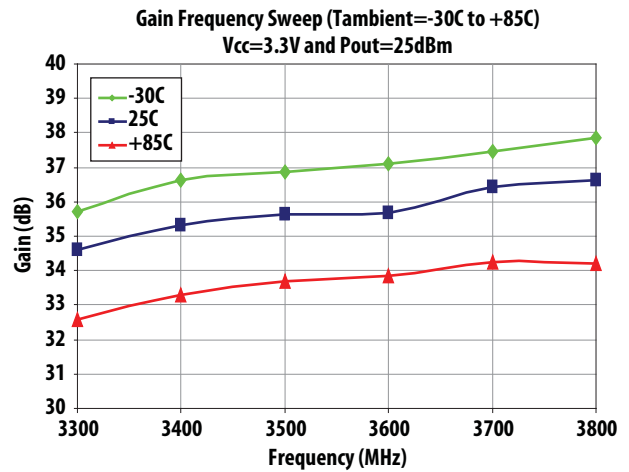

Figure 8. Gain Frequency Sweep at Vcc=3.3V and Pout=25dBm over Tambient

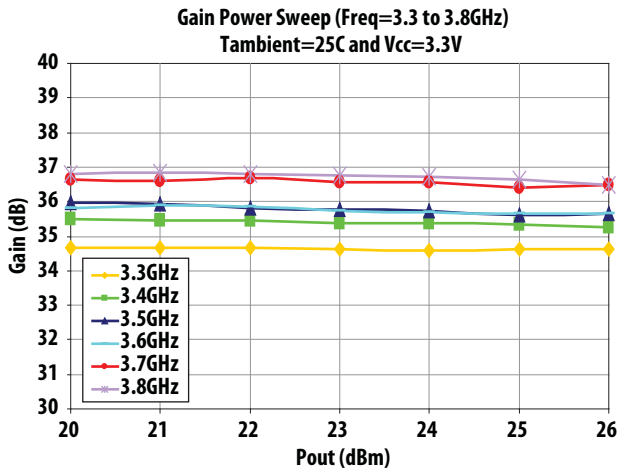

Figure 9. Gain Power Sweep at Vcc=3.3V and 25C over Pout

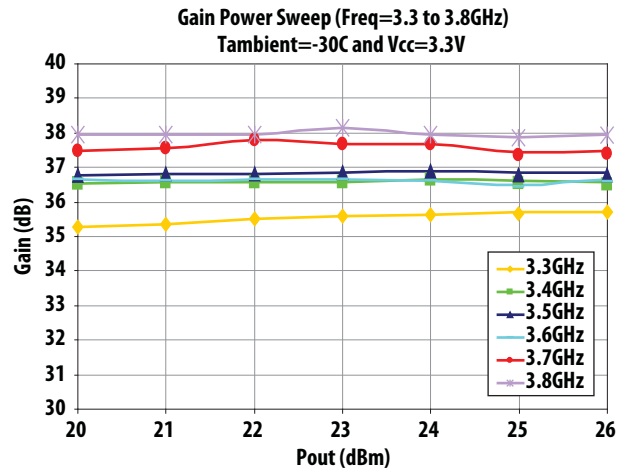

Figure 10. Gain Power Sweep at Vcc=3.3V and -30C over Frequency

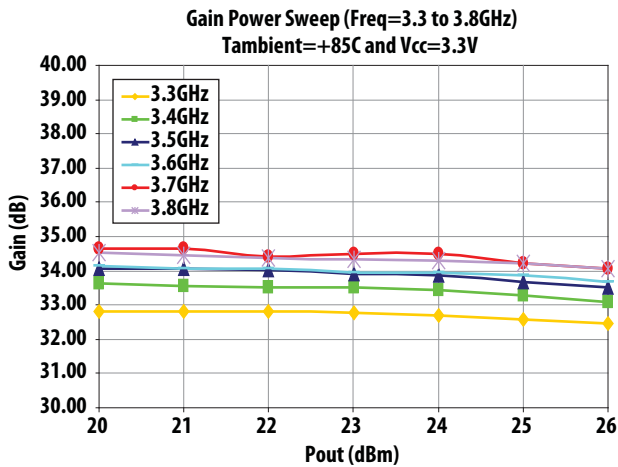

Figure 11. Gain Power Sweep at Vcc=3.3V and +85C over Frequency

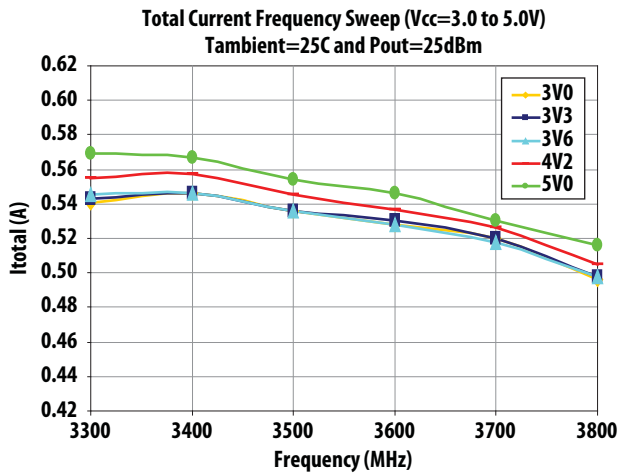

Figure 12. Total Current Frequency Sweep at 25C and Pout=25dBm over Vcc

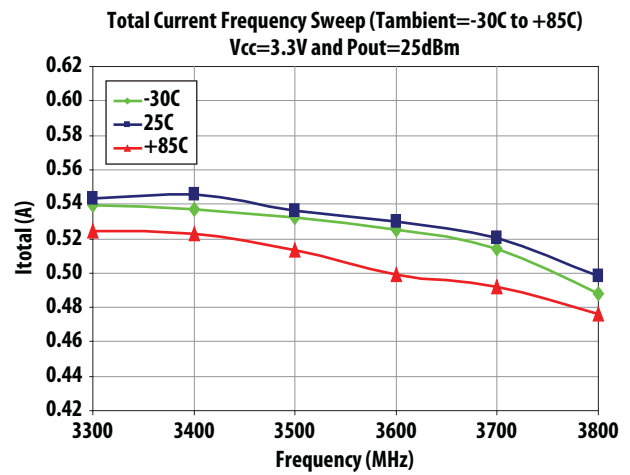

Figure 13. Total Current Frequency Sweep at 3.3V and Pout=25dBm over Tambient

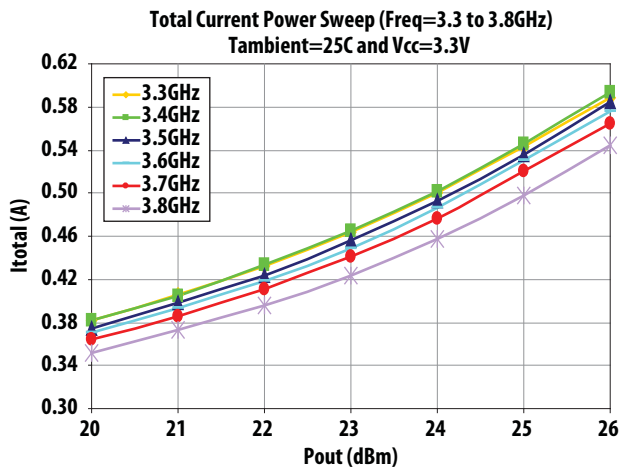

Figure 14. Total Current Power Sweep at 3.3V and 25C over Frequency

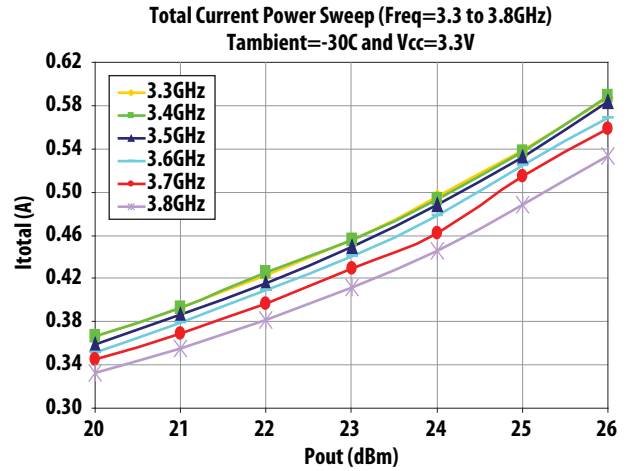

Figure 15. Total Current Power Sweep at 3.3V and -30C over Frequency

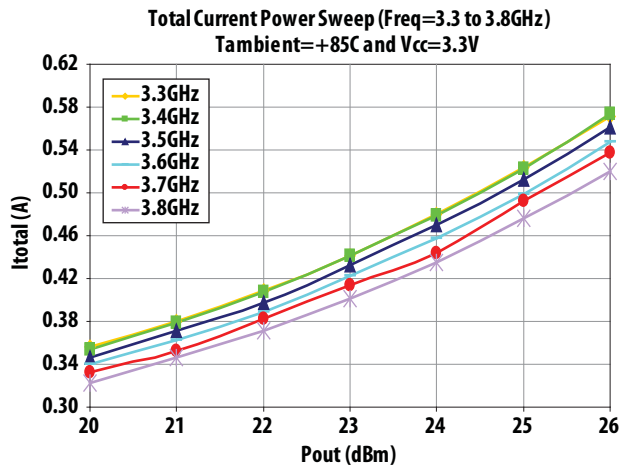

Figure 16. Total Current Power Sweep at 3.3V and +85C over Frequency

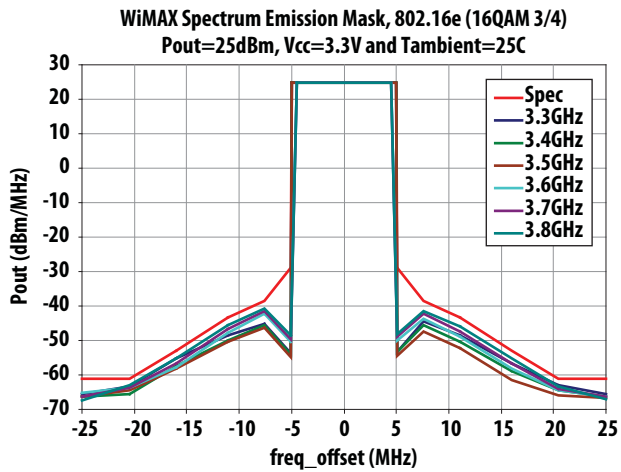

Figure 17. SEM Frequency Sweep at Vcc=3.3V and 25C (2dB Post-PA loss assumed)

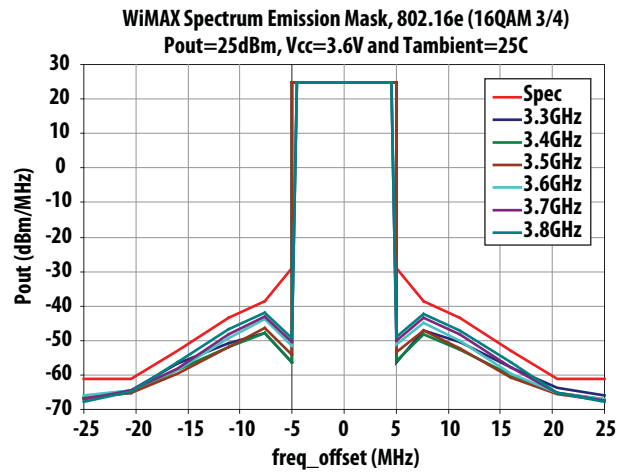

Figure 18. SEM Frequency Sweep at Vcc=3.6V and 25C (2dB Post-PA loss assumed)

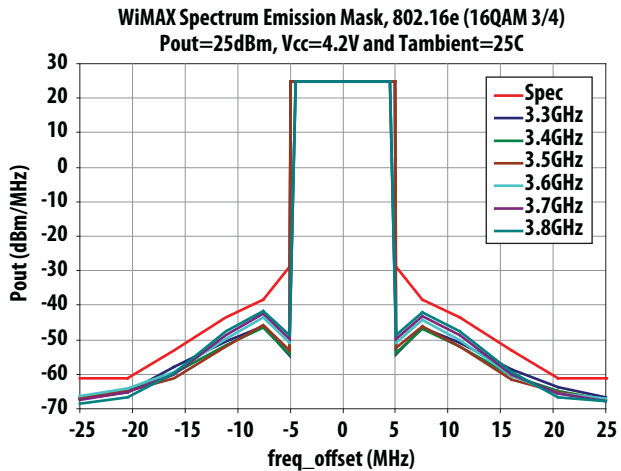

Figure 19. SEM Frequency Sweep at Vcc=4.2V and 25C (2dB Post-PA loss assumed)

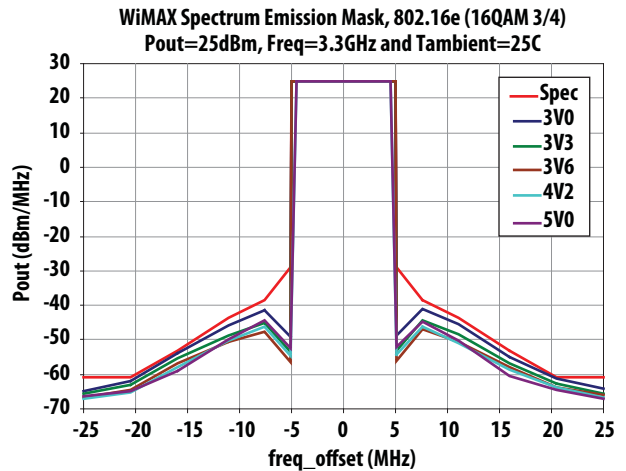

Figure 20. SEM at Vcc=3.3V, 25C and 3.3GHz over Vcc (2dB Post-PA loss assumed)

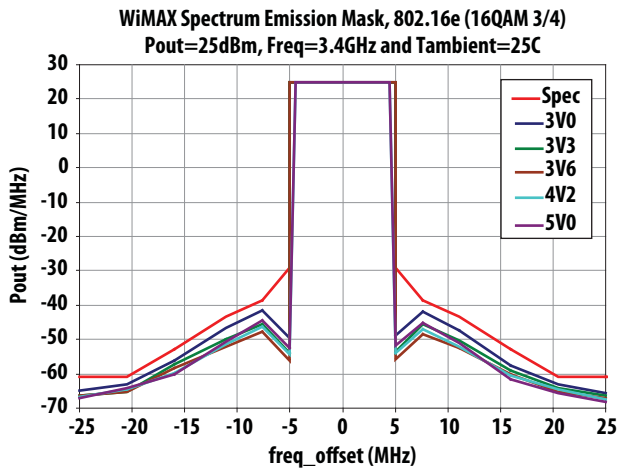

Figure 21. SEM at Vcc=3.3V, 25C and 3.4GHz over Vcc (2dB Post-PA loss assumed)

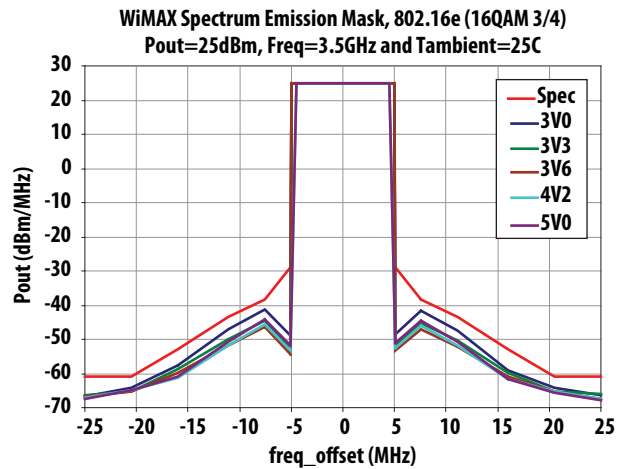

Figure 22. SEM at Vcc=3.3V, 25C and 3.5GHz over Vcc (2dB Post-PA loss assumed)

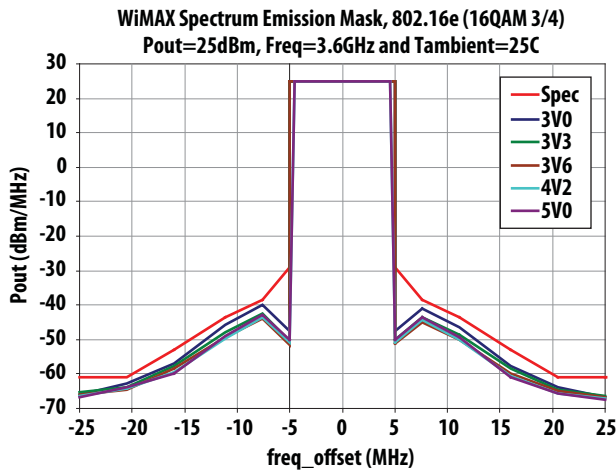

Figure 23. SEM at Vcc=3.3V, 25C and 3.6GHz over Vcc (2dB Post-PA loss assumed)

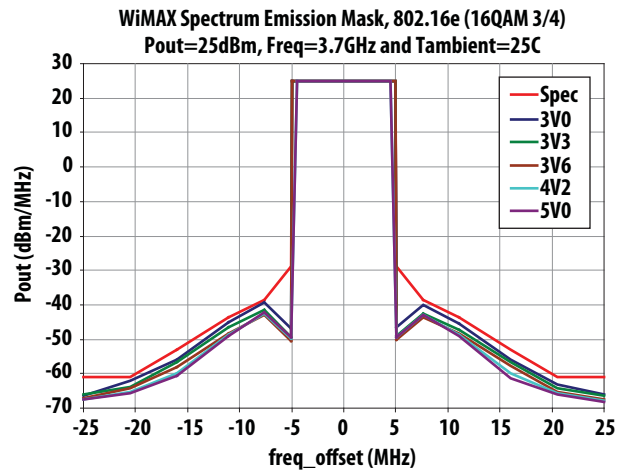

Figure 24. SEM at Vcc=3.3V, 25C and 3.7GHz over Vcc (2dB Post-PA loss assumed)

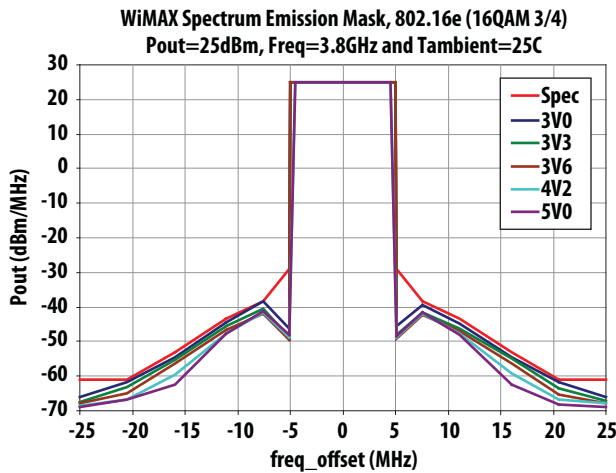

Figure 25. SEM at Vcc=3.3V, 25C and 3.8GHz over Vcc (2dB Post-PA loss assumed)

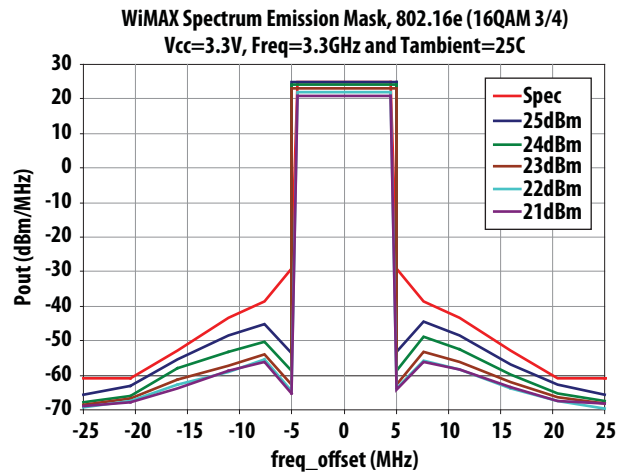

Figure 26. SEM at Vcc=3.3V, 25C and 3.3GHz over Vcc (2dB Post-PA loss assumed)

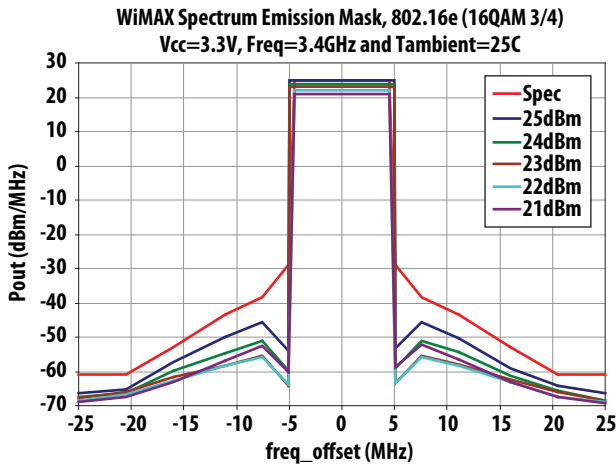

Figure 27. SEM at Vcc=3.3V, 25C and 3.4GHz over Vcc (2dB Post-PA loss assumed)

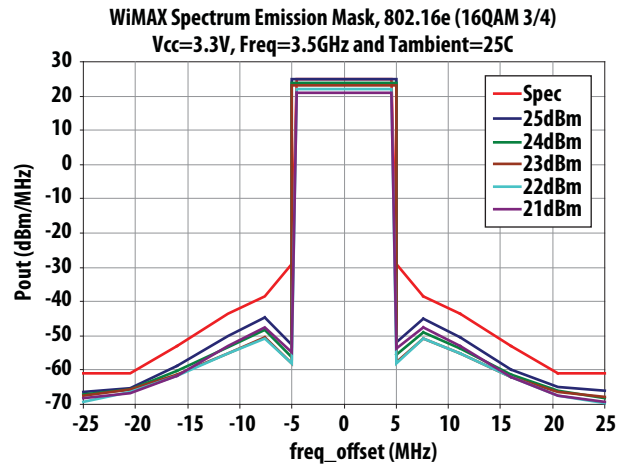

Figure 28. SEM at Vcc=3.3V, 25C and 3.5GHz over Vcc (2dB Post-PA loss assumed)

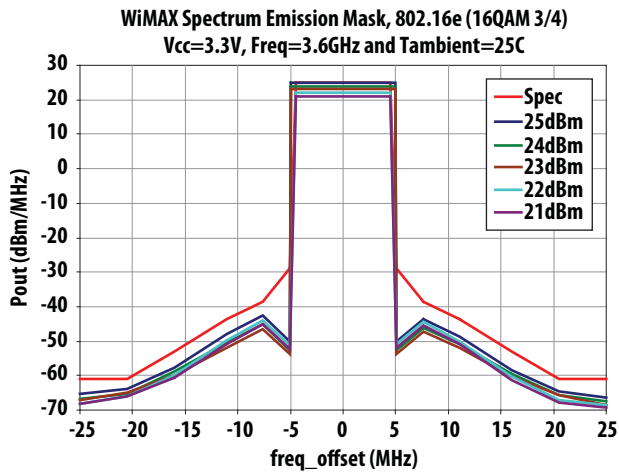

Figure 29. SEM at Vcc=3.3V, 25C and 3.6GHz over Vcc (2dB Post-PA loss assumed)

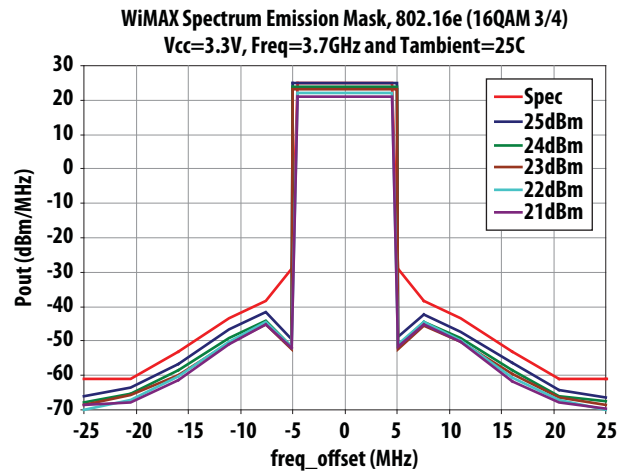

Figure 30. SEM at Vcc=3.3V, 25C and 3.7GHz over Vcc (2dB Post-PA loss assumed)

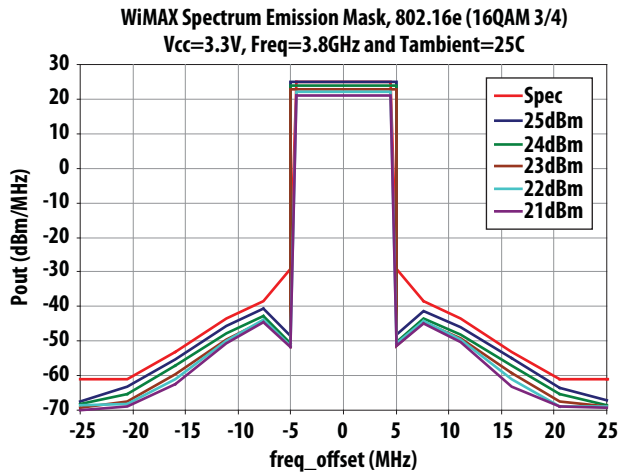

Figure 31. SEM at Vcc=3.3V, 25C and 3.8GHz over Vcc (2dB Post-PA loss assumed)

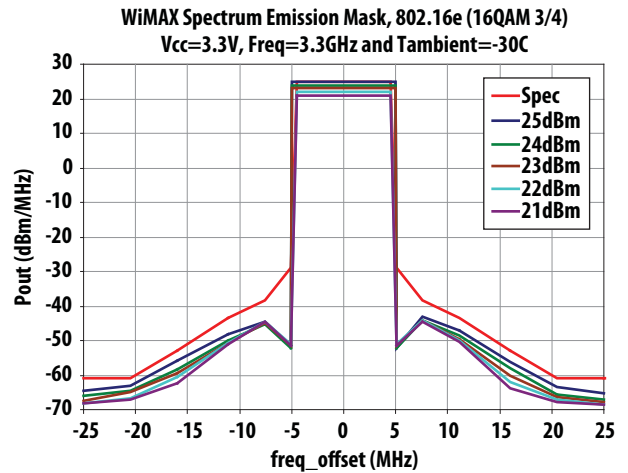

Figure 32. SEM at Vcc=3.3V, -30C and 3.3GHz over Vcc (2dB Post-PA loss assumed)

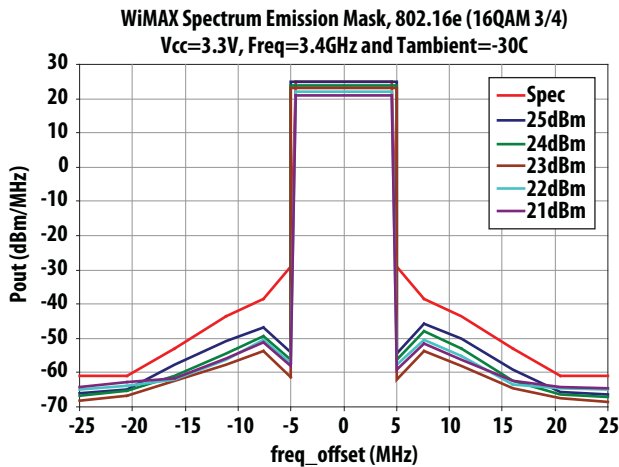

Figure 33. SEM at Vcc=3.3V, -30C and 3.4GHz over Vcc (2dB Post-PA loss assumed)

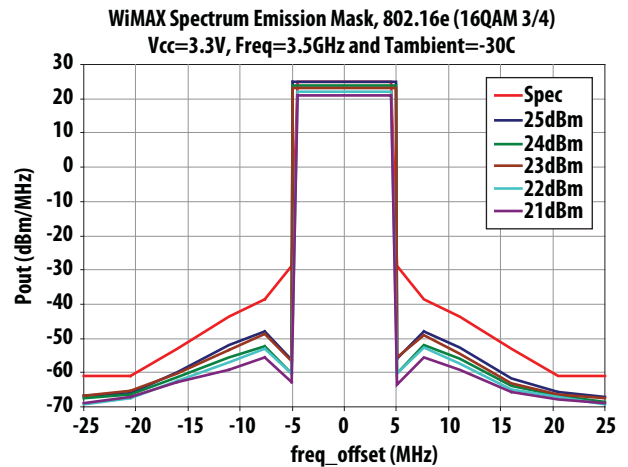

Figure 34. SEM at Vcc=3.3V, -30C and 3.5GHz over Vcc (2dB Post-PA loss assumed)

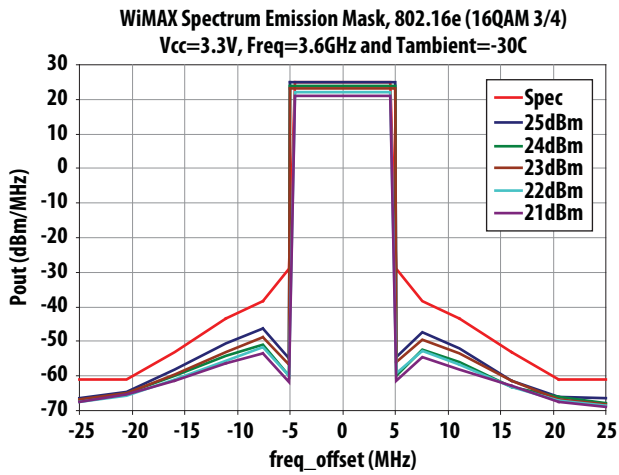

Figure 35. SEM at Vcc=3.3V, -30C and 3.6GHz over Vcc (2dB Post-PA loss assumed)

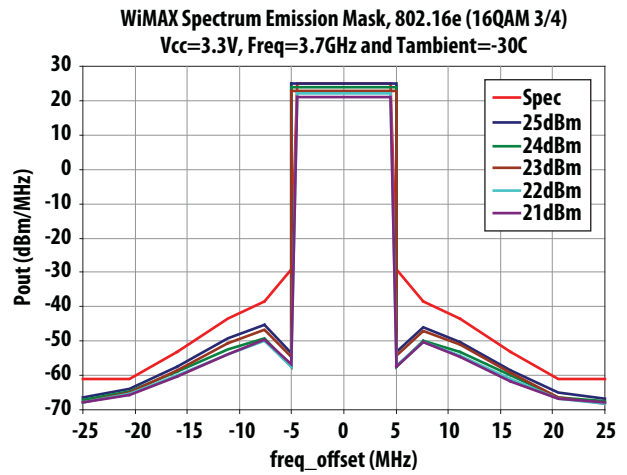

Figure 36. SEM at Vcc=3.3V, -30C and 3.7GHz over Vcc (2dB Post-PA loss assumed)

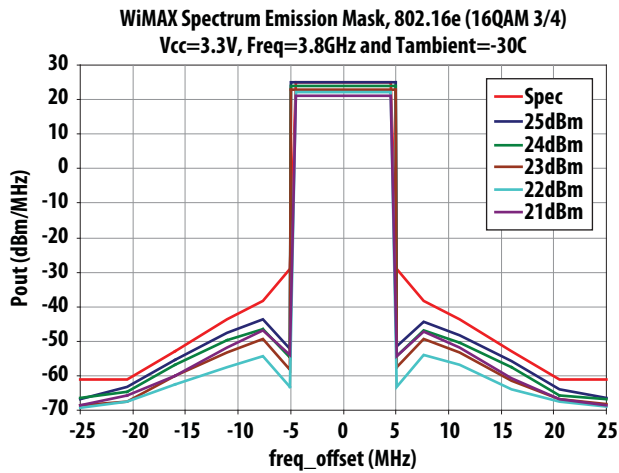

Figure 37. SEM at Vcc=3.3V, -30C and 3.8GHz over Vcc (2dB Post-PA loss assumed)

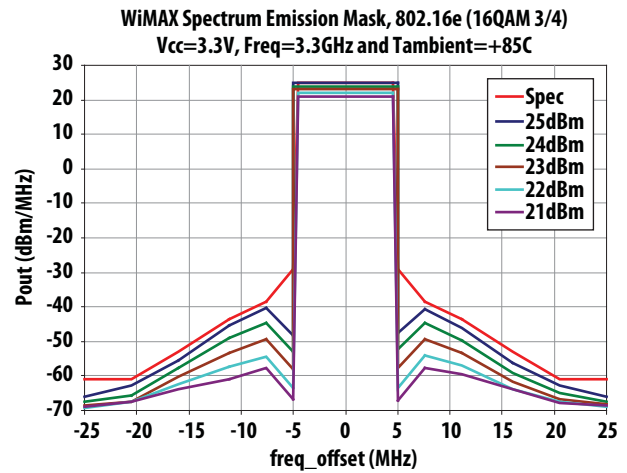

Figure 38. SEM at Vcc=3.3V, +85C and 3.3GHz over Vcc (2dB Post-PA loss assumed)

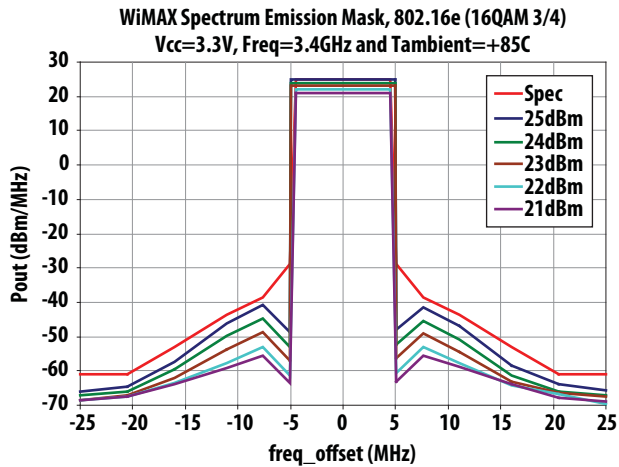

Figure 39. SEM at Vcc=3.3V, +85C and 3.4GHz over Vcc (2dB Post-PA loss assumed)

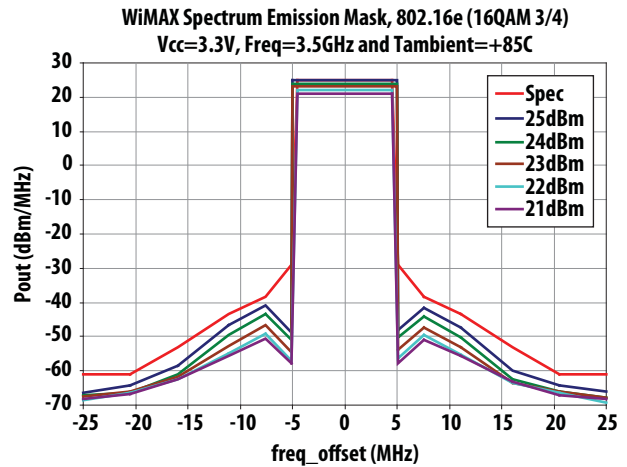

Figure 40. SEM at Vcc=3.3V, +85C and 3.5GHz over Vcc (2dB Post-PA loss assumed)

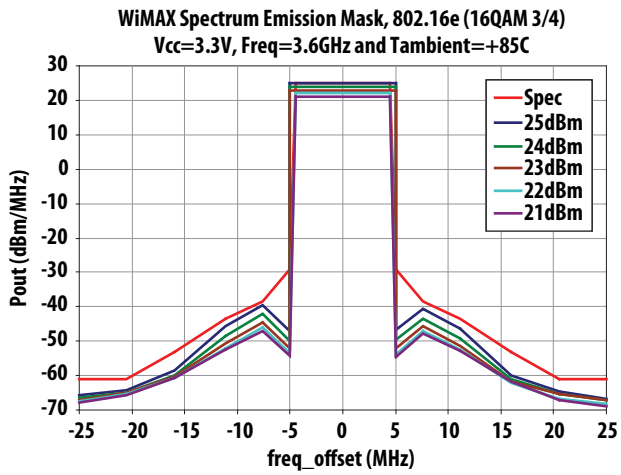

Figure 41. SEM at Vcc=3.3V, +85C and 3.6GHz over Vcc (2dB Post-PA loss assumed)

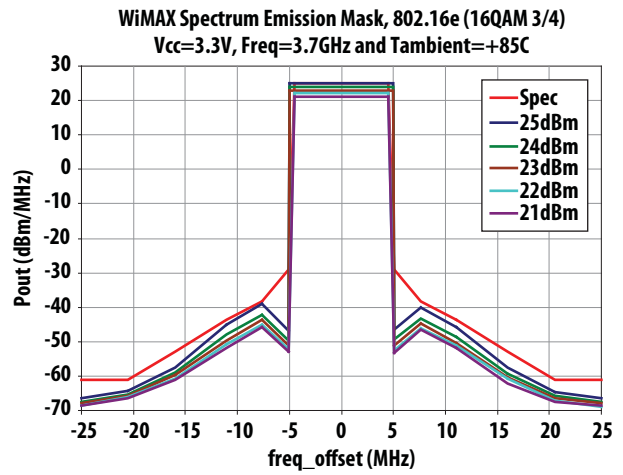

Figure 42. SEM at Vcc=3.3V, +85C and 3.7GHz over Vcc (2dB Post-PA loss assumed)

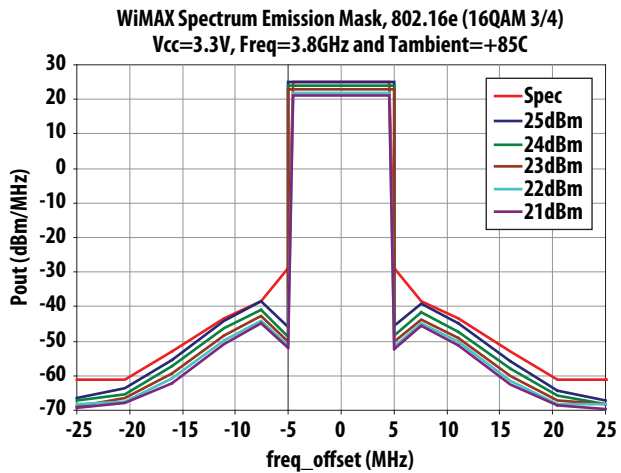

Figure 43. SEM at Vcc=3.3V, +85C and 3.8GHz over Vcc (2dB Post-PA loss assumed)

Evaluation Board Description

Table 4. Evaluation Board Pin Description

Top Pin No.	Function	Bottom Pin No.	Function
1	VCC2	2	VCC2_S
3	B_SPLY	4	GND
5	VCC1	6	GND
7	NC	8	GND
9	PAMOD	10	GND
11	NC	12	GND
13	NC	14	B_SW
15	B_CTRL	16	GND
17	NC	18	GND
19	NC	20	GND

Recommended turn on sequence

- Apply VCC1 and VCC2
- Apply BSPLY
- Apply BCTRL
- Apply BSW
- For HPM Apply PAMOD HI for LPM Apply PAMOD LO
- Apply RF In not to exceed 15dBm

Turn off in reverse order

Table 5. Typical Test Conditions

Pin	HPM	LPM	
VCC1,2	3.3V	3.3V	Supply Voltage
PAMOD	1.8V	0V	Low Power Mode
B_SPLY	3.3V	3.3V	Bias Voltage
B_CTRL	2.8V	2.8V	Bias Control
B_SW	1.8V	1.8V	PA Enable

Notes: VCC1, VCC2 and B_SPLY can be tied together to reduce supply voltages, but B_CTRL needs to be a regulated voltage which is optimized for 2.8V.

Demoboard Top Pins



Demoboard Bottom Pins

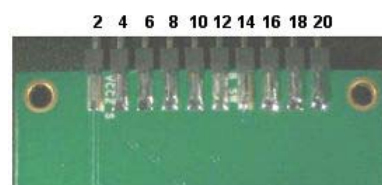

Application Circuit MGA-23003

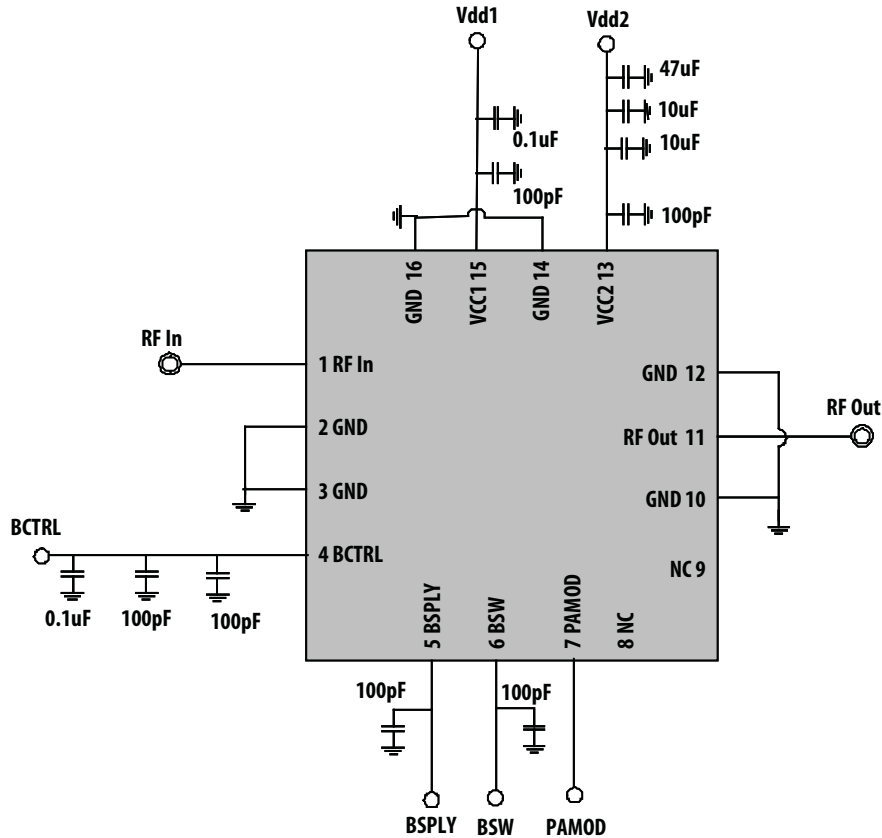

Using 3.3V or 5V Supply and tying Vcc1, Vcc2, BSPLY and BCTRL

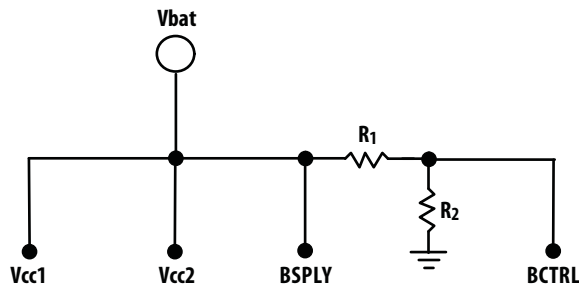

Notes: BCTRL regulates the device current, thus R1 and R2 should have good tolerance rating. If available, a voltage regulator is the preferred method of bias.

In this example we set R2 at 40KOhm and solve for R1 with simple voltage divider equation. Note this method will cause some leakage current through R2.

3.3V Example :

$$V_{BCTRL} = \frac{R_2}{R_1 + R_2} * V_{BATT}$$

$$2.8V = \frac{40K\Omega}{R_1 + 40K\Omega} * 3.3V$$

$$R_1 = 7K\Omega$$

$$R_2 = 40K\Omega$$

Given :

$$V_{BCTRL} = 2.8V$$

$$V_{BAT} = 3.3V$$

$$R_2 = 40K\Omega$$

$$R_1 = ?$$

5.0V Example :

$$V_{BCTRL} = \frac{R_2}{R_1 + R_2} * V_{BATT}$$

$$2.0V = \frac{20K\Omega}{R_1 + 20K\Omega} * 5.0V$$

$$R_1 = 30K\Omega$$

$$R_2 = 20K\Omega$$

Given :

$$V_{BCTRL} = 2.0V$$

$$V_{BAT} = 5.0V$$

$$R_2 = 20K\Omega$$

$$R_1 = ?$$

Land Pattern

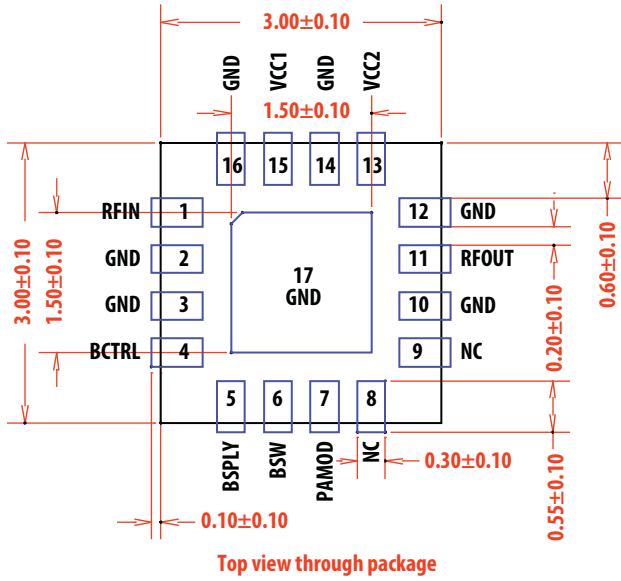

Figure 44. Recommended footprint

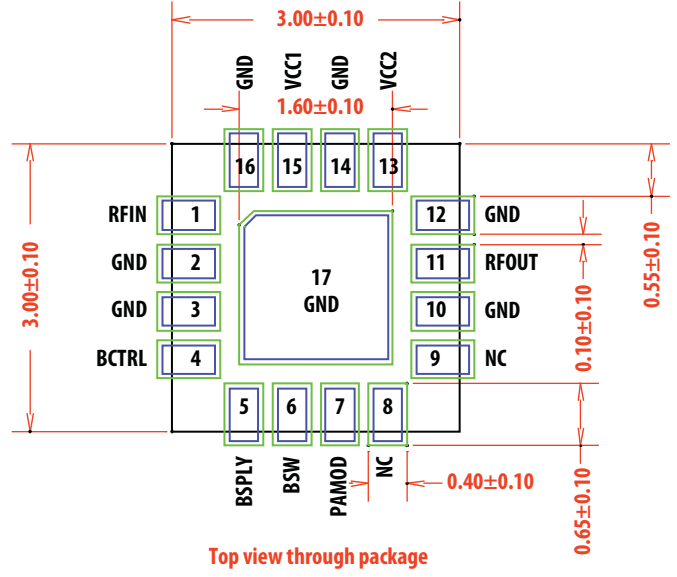

Figure 45. Recommended mask opening

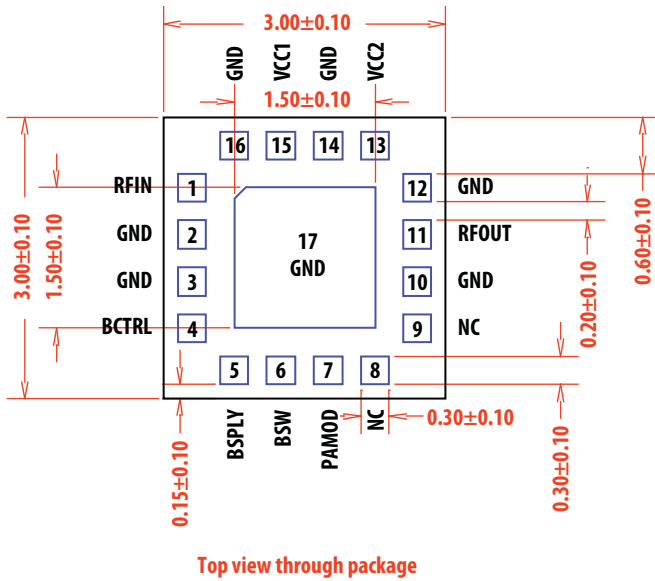

Figure 46. Package dimensions

- Notes:
1. All units are in millimeters
 2. Package is symmetrical

Ordering Information

Part Number	No. of Devices	Container
MGA-23003-BLKG	100	7" Reel
MGA-23003-TR1G	3000	13" Reel

Package Dimensions

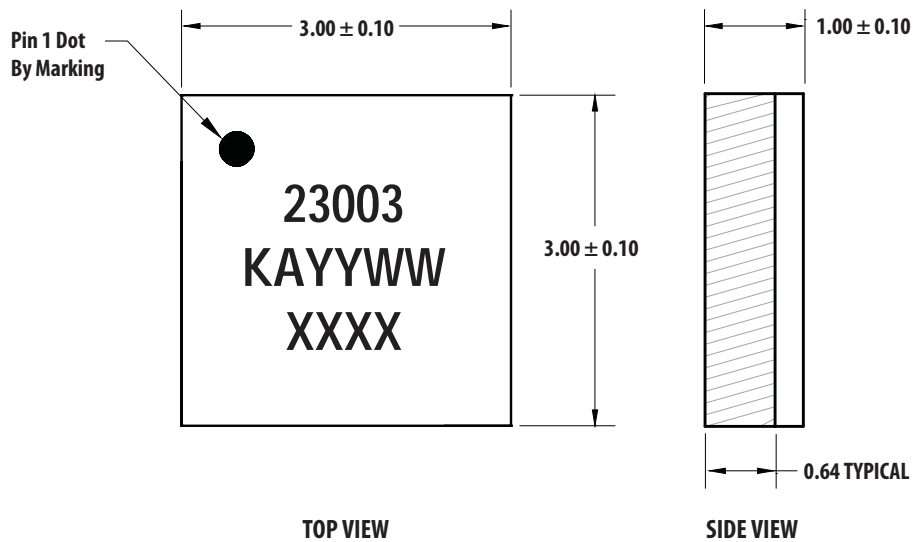

Note

1. All dimensions are in millimeters.
2. Dimensions are inclusive of plating.
3. Dimensions are exclusive of mold flash and metal burr.

Device Orientation

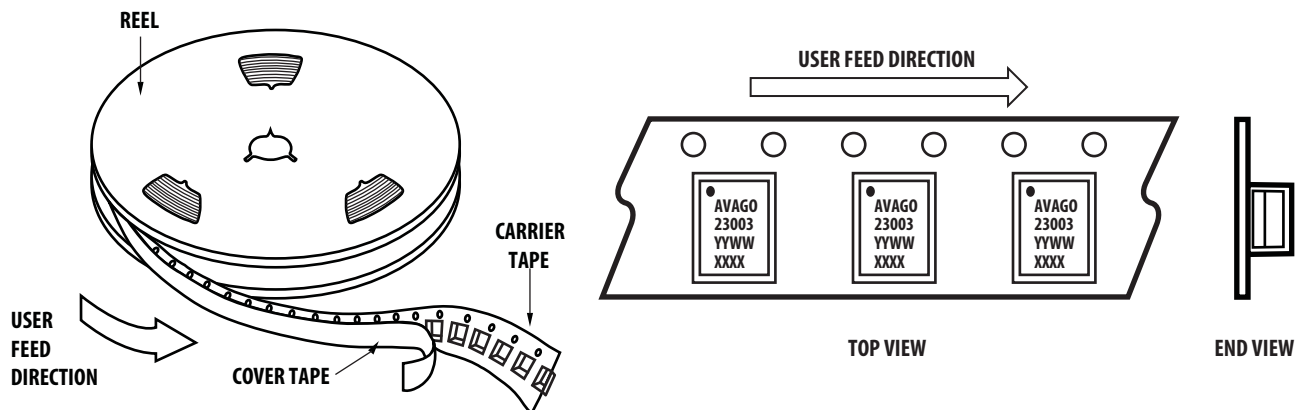

Tape and Reel Information

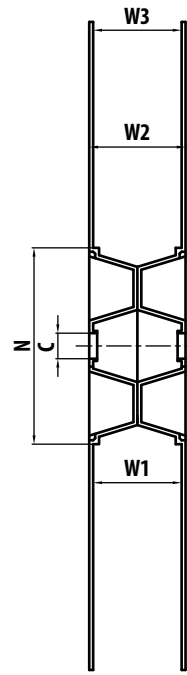
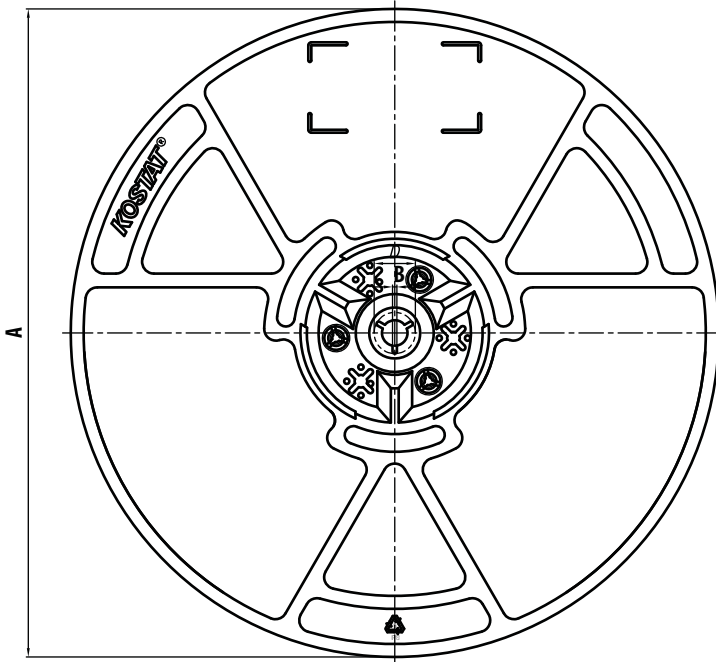

Size	12mm
A	330 ^{+2.0} _{-2.0}
B	1.5min.
C	13.0 ^{+0.5} _{-0.2}
D	20.2min.
N	100 ^{+3.0} _{-0.0}
W1	12.4 ^{+3.0} _{-0.0}
W2	16.4 ^{+2.0} _{-2.0}
W3	13.65 ^{+1.75} _{-0.75}

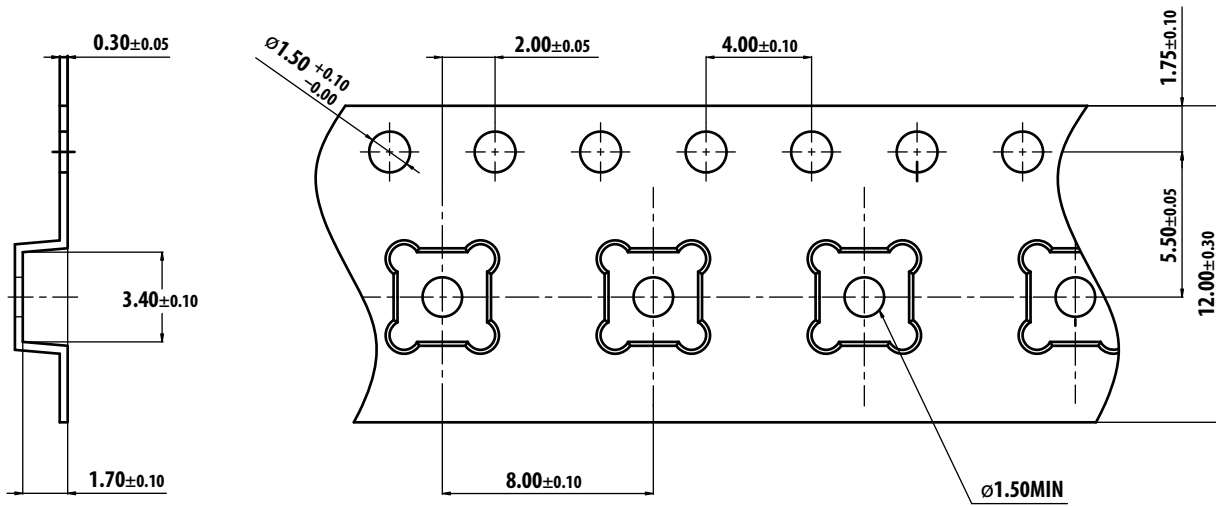
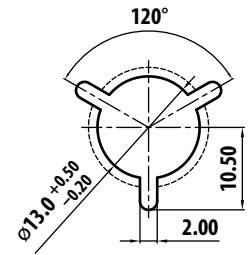

Handling and Storage

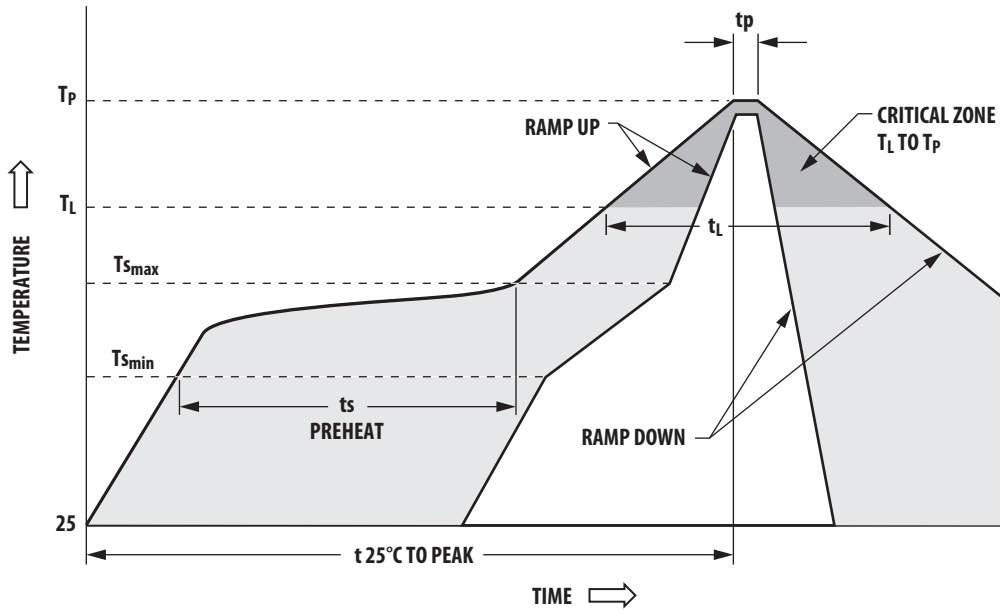

Typical SMT Reflow Profile for Maximum Temperature = 260+0/-5°C

Profile Feature	Sn-Pb Solder	Pb-Free Solder
Average ramp-up rate (TL to TP)	3°C/sec max	3°C/sec max
Preheat		
– Temperature Min (T _{smin})	100°C	100°C
– Temperature Max (T _{smax})	150°C	150°C
– Time (mon to max) (t _s)	60-120 sec	60-180 sec
T _{smax} to T _L		
– Ramp-up Rate		3°C/sec max
Time maintained above:		
– Temperature (T _L)	183°C	217°C
– Time (T _L)	60-150 sec	60-150 sec
Peak temperature (T _p)	240 +0/-5°C	260 +0/-5°C
Time within 5°C of actual Peak Temperature (t _p)	10-30 sec	10-30 sec
Ramp-down Rate	6°C/sec max	6°C/sec max
Time 25°C to Peak Temperature	6 min max	8 min max

For product information and a complete list of distributors, please go to our web site: www.avagotech.com

Avago, Avago Technologies, and the A logo are trademarks of Avago Technologies in the United States and other countries. Data subject to change. Copyright © 2005-2012 Avago Technologies. All rights reserved.
AV02-1960EN - September 14, 2012

AVAGO
TECHNOLOGIES