

**CoolMOS™ Power Transistor**
**Features**

- New revolutionary high voltage technology
- Intrinsic fast-recovery body diode
- Extremely low reverse recovery charge
- Ultra low gate charge
- Extreme dv/dt rated
- High peak current capability
- Periodic avalanche rated
- Qualified according to JEDEC<sup>0)</sup> for target applications
- Pb-free lead plating; RoHS compliant

**Product Summary**

$V_{DS}$	600	V
$R_{DS(on),max}$	0.22	$\Omega$
$I_D^{1)}$	20.7	A

PG-TO220-3-31

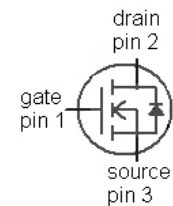
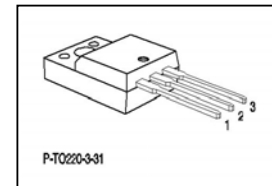

Type	Package	Ordering Code	Marking
SPA20N60CFD	PG-TO220-3-31	SP000216361	20N60CFD

**Maximum ratings, at  $T_j=25\text{ °C}$ , unless otherwise specified**

Parameter	Symbol	Conditions	Value	Unit
Continuous drain current <sup>1)</sup>	$I_D$	$T_C=25\text{ °C}$	20.7	A
		$T_C=100\text{ °C}$	13.1	
Pulsed drain current <sup>2)</sup>	$I_{D,pulse}$	$T_C=25\text{ °C}$	52	
Avalanche energy, single pulse	$E_{AS}$	$I_D=10\text{ A}$ , $V_{DD}=50\text{ V}$	690	mJ
Avalanche energy, repetitive $t_{AR}^{2),3)}$	$E_{AR}$	$I_D=20\text{ A}$ , $V_{DD}=50\text{ V}$	1	
Avalanche current, repetitive $t_{AR}^{2),3)}$	$I_{AR}$		20	A
Drain source voltage slope	dv/dt	$I_D=20.7\text{ A}$ , $V_{DS}=480\text{ V}$ , $T_j=125\text{ °C}$	80	V/ns
Reverse diode dv/dt	dv/dt	$I_S=20.7\text{ A}$ , $V_{DS}=480\text{ V}$ , $T_j=125\text{ °C}$	40	V/ns
Maximum diode commutation speed	di/dt	$T_j=125\text{ °C}$	900	A/ $\mu$ s
Gate source voltage	$V_{GS}$	static	$\pm 20$	V
		AC ( $f>1\text{ Hz}$ )	$\pm 30$	
Power dissipation	$P_{tot}$	$T_C=25\text{ °C}$	35	W
Operating and storage temperature	$T_j$ , $T_{stg}$		-55 ... +150	$^{\circ}\text{C}$

Parameter	Symbol	Conditions	Values			Unit
			min.	typ.	max.	

**Thermal characteristics**

Thermal resistance, junction - case	$R_{thJC}$		-	-	3.6	K/W
Thermal resistance, junction - ambient	$R_{thJA}$	leaded	-	-	62	
Soldering temperature, wave soldering	$T_{sold}$	1.6 mm (0.063 in.) from case for 10 s	-	-	260	°C

**Electrical characteristics**, at  $T_j=25\text{ °C}$ , unless otherwise specified

**Static characteristics**

Drain-source breakdown voltage	$V_{(BR)DSS}$	$V_{GS}=0\text{ V}$ , $I_D=250\text{ }\mu\text{A}$	600	-	-	V
Avalanche breakdown voltage	$V_{(BR)DS}$	$V_{GS}=0\text{ V}$ , $I_D=20\text{ A}$	-	700	-	
Gate threshold voltage	$V_{GS(th)}$	$V_{DS}=V_{GS}$ , $I_D=1000\mu\text{A}$	3	4	5	
Zero gate voltage drain current	$I_{DSS}$	$V_{DS}=600\text{ V}$ , $V_{GS}=0\text{ V}$ , $T_j=25\text{ °C}$	-	2.1	-	$\mu\text{A}$
		$V_{DS}=600\text{ V}$ , $V_{GS}=0\text{ V}$ , $T_j=150\text{ °C}$	-	1700	-	
Gate-source leakage current	$I_{GSS}$	$V_{GS}=20\text{ V}$ , $V_{DS}=0\text{ V}$	-	-	100	nA
Drain-source on-state resistance	$R_{DS(on)}$	$V_{GS}=10\text{ V}$ , $I_D=13.1\text{ A}$ , $T_j=25\text{ °C}$	-	0.19	0.22	$\Omega$
		$V_{GS}=10\text{ V}$ , $I_D=13.1\text{ A}$ , $T_j=150\text{ °C}$	-	0.43	-	
Gate resistance	$R_G$	$f=1\text{ MHz}$ , open drain	-	0.54	-	
Transconductance	$g_{fs}$	$ V_{DS} >2 I_D R_{DS(on)max}$ , $I_D=13.1\text{ A}$	-	17.5	-	S

Parameter	Symbol	Conditions	Values			Unit
			min.	typ.	max.	

**Dynamic characteristics**

Input capacitance	$C_{iss}$	$V_{GS}=0\text{ V}, V_{DS}=25\text{ V},$ $f=1\text{ MHz}$	-	2400	-	pF
Output capacitance	$C_{oss}$		-	780	-	
Reverse transfer capacitance	$C_{rss}$		-	50	-	
Effective output capacitance, energy related <sup>4)</sup>	$C_{o(er)}$	$V_{GS}=0\text{ V}, V_{DS}=0\text{ V}$ to 480 V	-	83	-	
Effective output capacitance, time related <sup>5)</sup>	$C_{o(tr)}$		-	160	-	
Turn-on delay time	$t_{d(on)}$	$V_{DD}=380\text{ V},$ $V_{GS}=10\text{ V}, I_D=20.7\text{ A},$ $R_G=3.6\ \Omega$	-	12	-	ns
Rise time	$t_r$		-	15	-	
Turn-off delay time	$t_{d(off)}$		-	59	-	
Fall time	$t_f$		-	6.4	-	

**Gate Charge Characteristics**

Gate to source charge	$Q_{gs}$	$V_{DD}=480\text{ V},$ $I_D=20.7\text{ A},$ $V_{GS}=0\text{ to }10\text{ V}$	-	15	-	nC
Gate to drain charge	$Q_{gd}$		-	54	-	
Gate charge total	$Q_g$		-	95	124	
Gate plateau voltage	$V_{plateau}$		-	7.0	-	V

<sup>0)</sup> J-STD20 and JESD22

<sup>1)</sup> Limited only by maximum temperature.

<sup>2)</sup> Pulse width  $t_p$  limited by  $T_{j,max}$

<sup>3)</sup> Repetitive avalanche causes additional power losses that can be calculated as  $P_{AV}=E_{AR} \cdot f$ .

<sup>4)</sup>  $C_{o(er)}$  is a fixed capacitance that gives the same stored energy as  $C_{oss}$  while  $V_{DS}$  is rising from 0 to 80%  $V_{DSS}$ .

<sup>5)</sup>  $C_{o(tr)}$  is a fixed capacitance that gives the same charging time as  $C_{oss}$  while  $V_{DS}$  is rising from 0 to 80%  $V_{DSS}$ .

Parameter	Symbol	Conditions	Values			Unit
			min.	typ.	max.	
<b>Reverse Diode</b>						
Diode continuous forward current <sup>1)</sup>	$I_S$	$T_C=25\text{ }^\circ\text{C}$	-	-	20.7	A
Diode pulse current <sup>2)</sup>	$I_{S,pulse}$		-	-	52	
Diode forward voltage	$V_{SD}$	$V_{GS}=0\text{ V}, I_F=20.7\text{ A}, T_j=25\text{ }^\circ\text{C}$	-	1.0	1.2	V
Reverse recovery time	$t_{rr}$	$V_R=480\text{ V}, I_F=I_S, di_F/dt=100\text{ A}/\mu\text{s}$	-	150	-	ns
Reverse recovery charge	$Q_{rr}$		-	1	-	$\mu\text{C}$
Peak reverse recovery current	$I_{rrm}$		-	13	-	A

**Typical Transient Thermal Characteristics**

Symbol	Value	Unit	Symbol	Value	Unit
	typ.			typ.	
$R_{th1}$	0.00862	K/W	$C_{th1}$	0.000205	Ws/K
$R_{th2}$	0.0471		$C_{th2}$	0.00198	
$R_{th3}$	0.119		$C_{th3}$	0.0068	
$R_{th4}$	0.476		$C_{th4}$	0.0482	
$R_{th5}$	1.57		$C_{th5}$	0.957	
			$C_{th6}$	0.1	

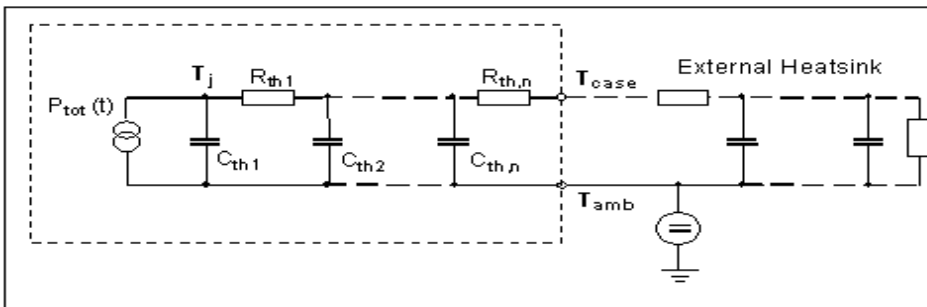

<sup>5)</sup>  $C_{th6}$  models the additional heat capacitance of the package in case of non-ideal cooling. It is not needed if  $R_{thCA}=0\text{ K/W}$ .

**1 Power dissipation**

$$P_{TOT}=f(T_C)$$

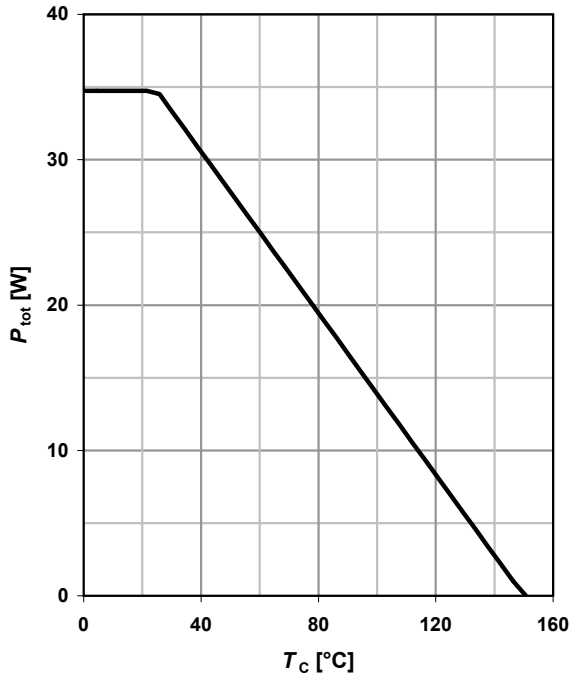

**2 Safe operating area**

$$I_D=f(V_{DS}); T_C=25\text{ °C}; D=0$$

parameter:  $t_p$

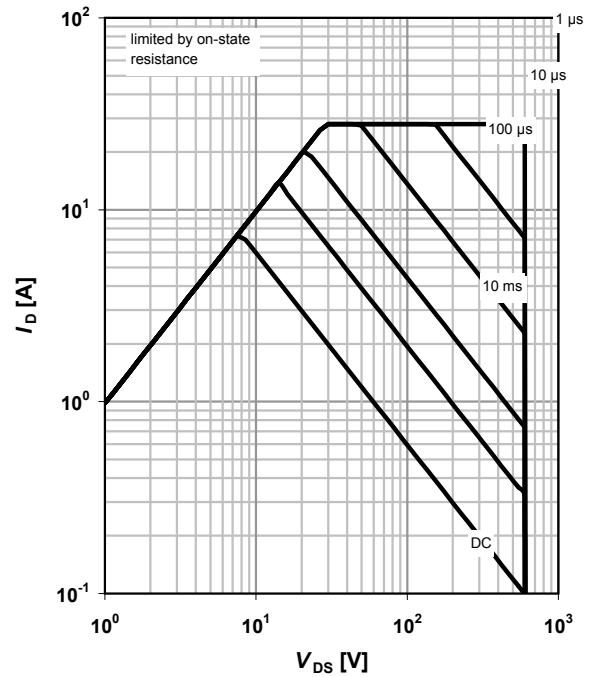

**3 Max. transient thermal impedance**

$$Z_{thJC}=f(t_p)$$

parameter:  $D=t_p/T$

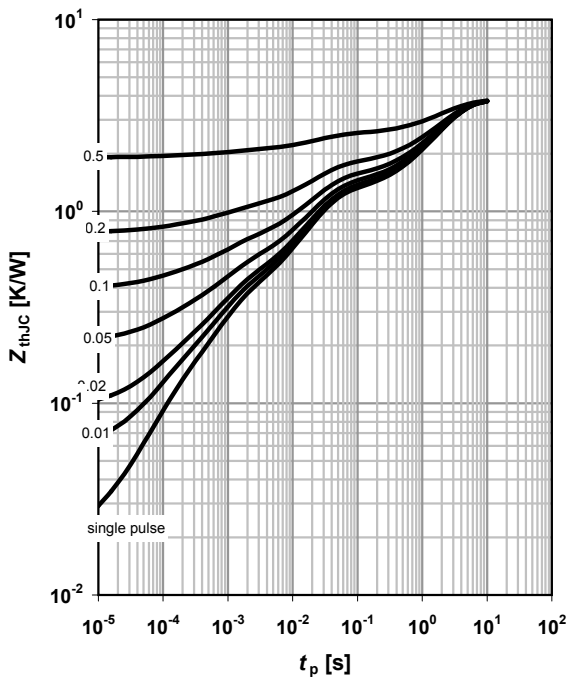

**4 Typ. output characteristics**

$$I_D=f(V_{DS}); T_j=25\text{ °C}$$

parameter:  $V_{GS}$

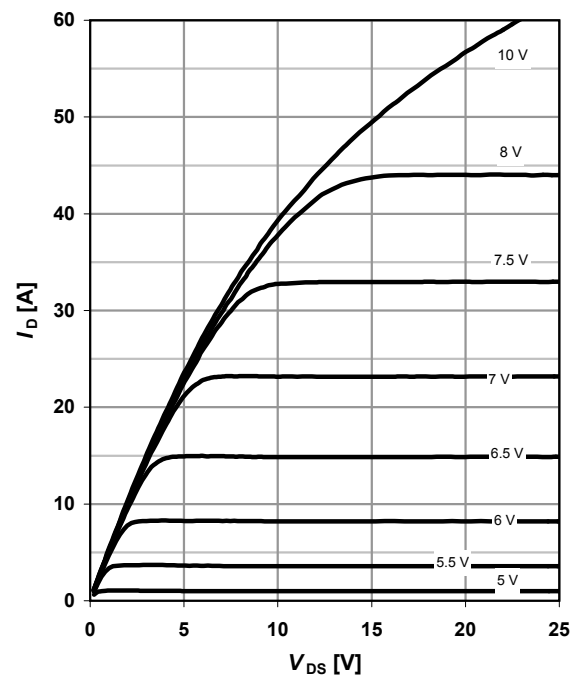

**5 Typ. output characteristics**

$I_D = f(V_{DS}); T_j = 150^\circ\text{C}$

parameter:  $V_{GS}$

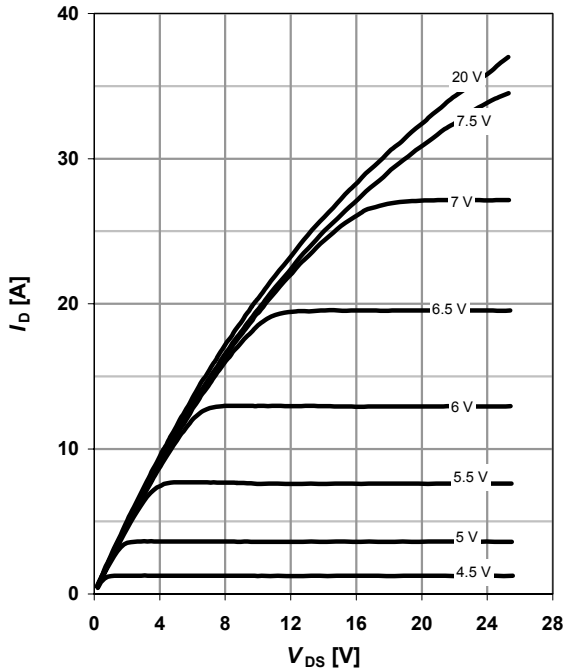

**6 Typ. drain-source on-state resistance**

$R_{DS(on)} = f(I_D); T_j = 150^\circ\text{C}$

parameter:  $V_{GS}$

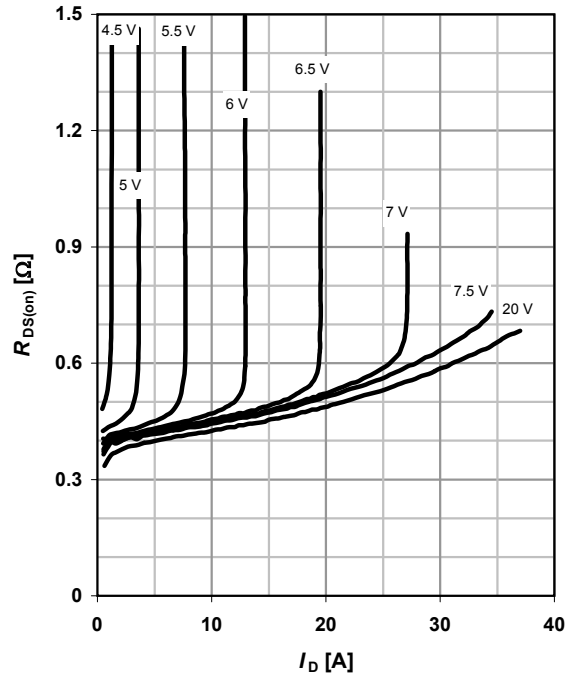

**7 Drain-source on-state resistance**

$R_{DS(on)} = f(T_j); I_D = 13.1\text{ A}; V_{GS} = 10\text{ V}$

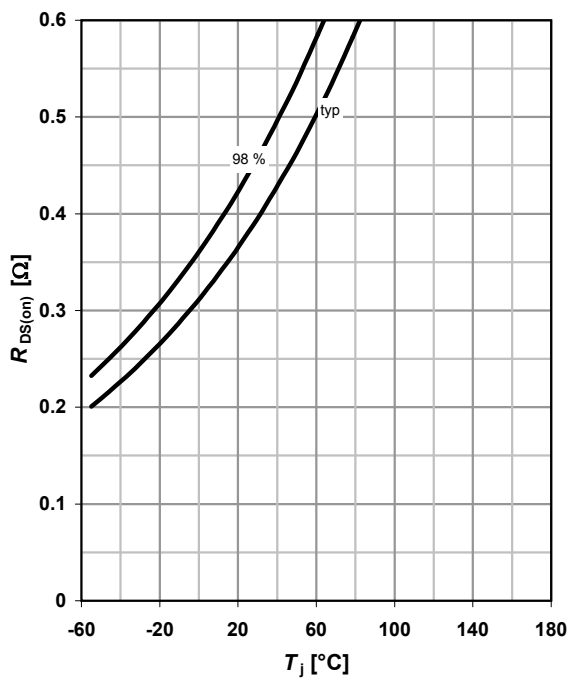

**8 Typ. transfer characteristics**

$I_D = f(V_{GS}); |V_{DS}| > 2I_D/R_{DS(on)max}$

parameter:  $T_j$

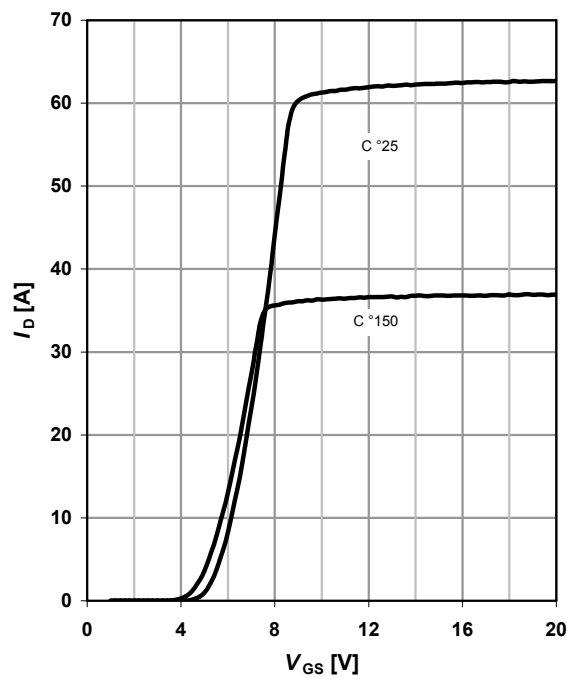

**9 Typ. gate charge**

$V_{GS}=f(Q_{gate}); I_D=20.7 \text{ A pulsed}$

parameter:  $V_{DD}$

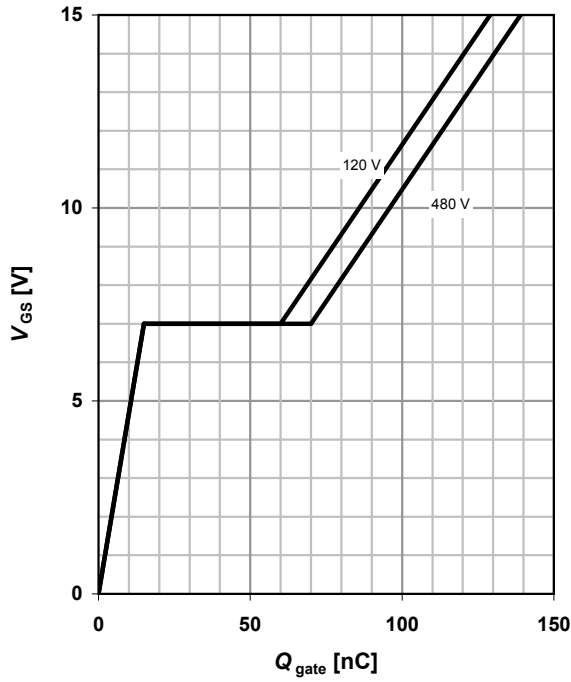

**10 Forward characteristics of reverse diode**

$I_F=f(V_{SD})$

parameter:  $T_j$

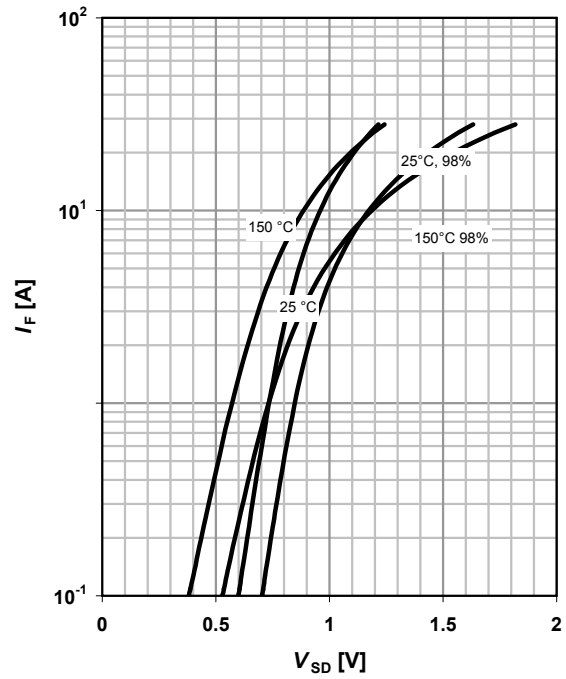

**11 Avalanche SOA**

$I_{AR}=f(t_{AR})$

parameter:  $T_{j(start)}$

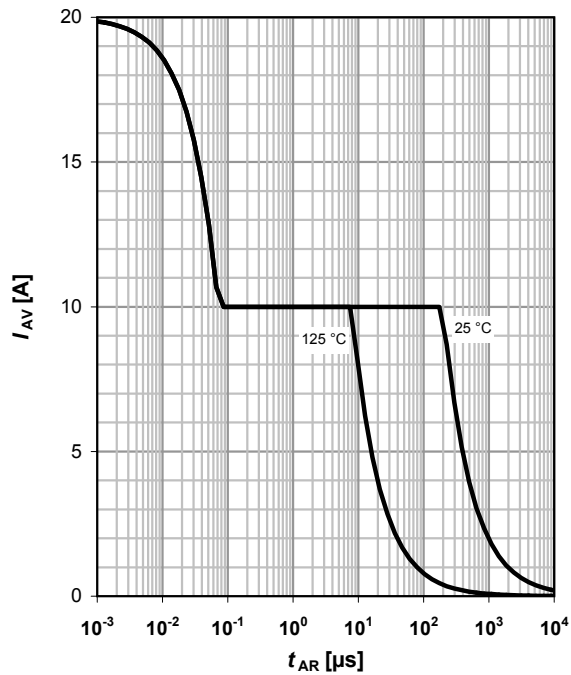

**12 Avalanche energy**

$E_{AS}=f(T_j); I_D=10 \text{ A}; V_{DD}=50 \text{ V}$

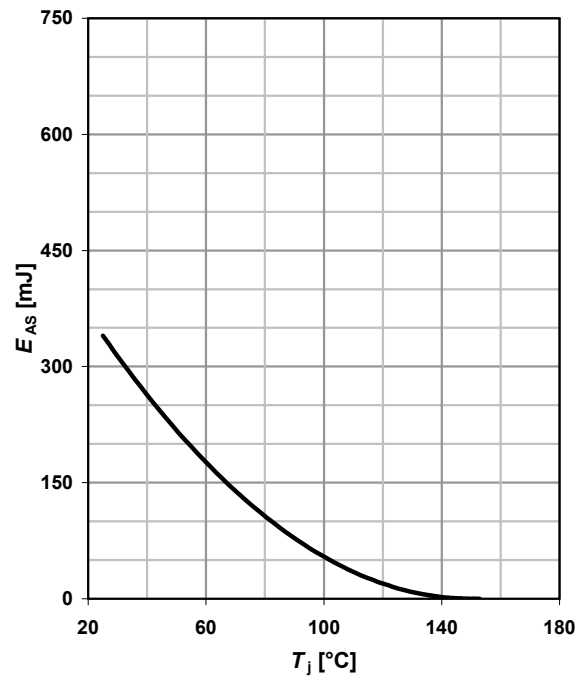

**13 Drain-source breakdown voltage**

$V_{BR(DSS)} = f(T_j); I_D = 10\text{mA}$

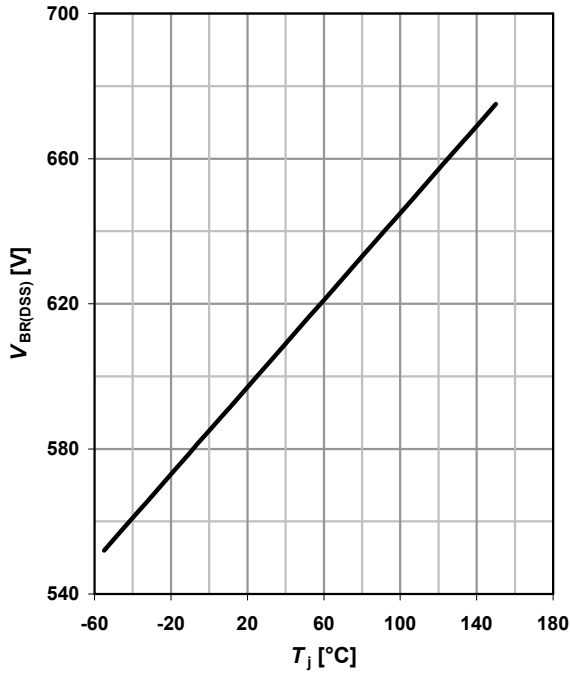

**14 Typ. capacitances**

$C = f(V_{DS}); V_{GS} = 0\text{ V}; f = 1\text{ MHz}$

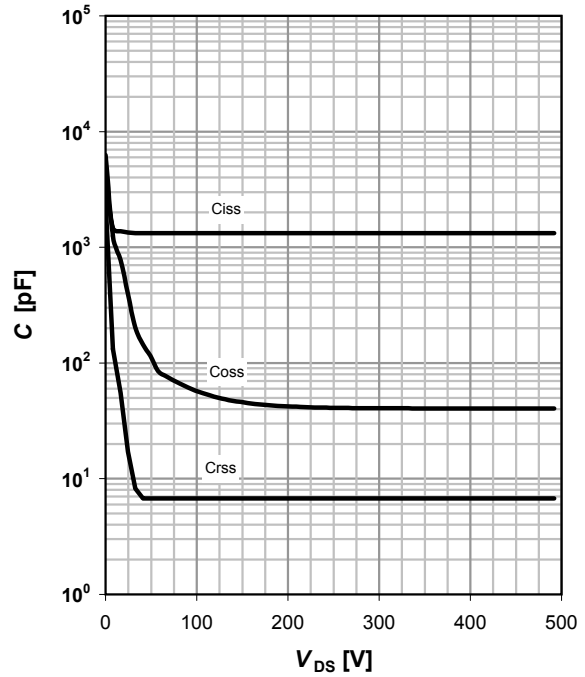

**15 Typ.  $C_{oss}$  stored energy**

$E_{oss} = f(V_{DS})$

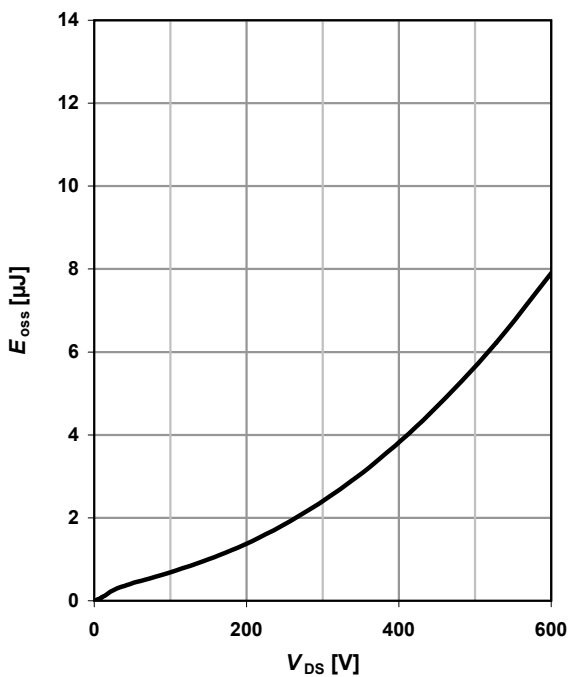

**16 Typ. reverse recovery charge**

$Q_{rr} = f(T_j); I_S = 20.7\text{ A}$

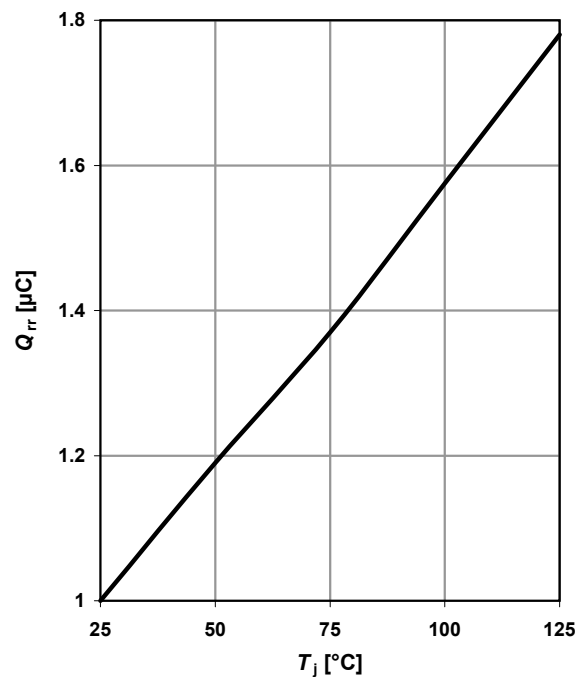



**17 Typ. reverse recovery charge**

$Q_{rr} = f(I_S); di/dt = 100 A/\mu s$

parameter:  $T_j$

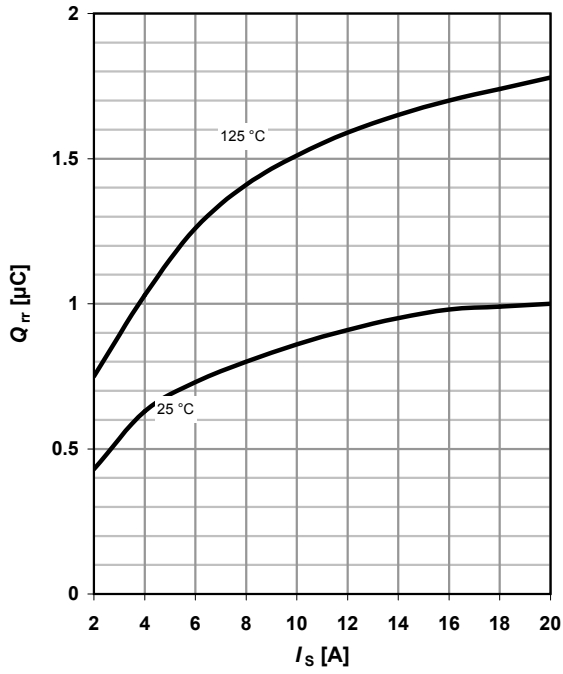

**18 Typ. reverse recovery charge**

$Q_{rr} = f(di/dt); I_D = 20.7 A$

parameter:  $T_j$

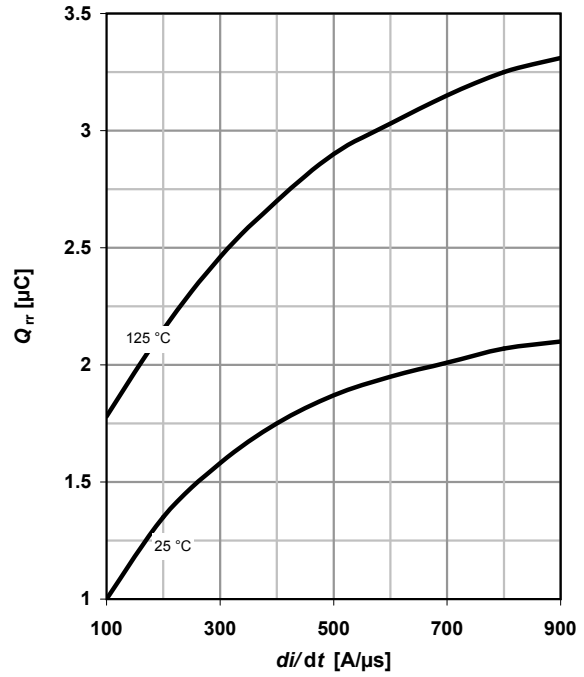

Definition of diode switching characteristics

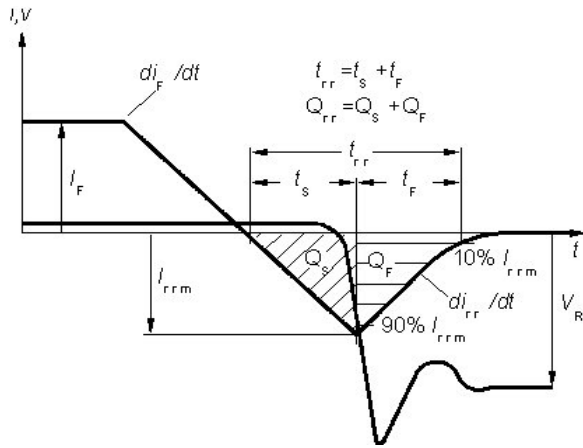

PG-TO220-3-31: Outline

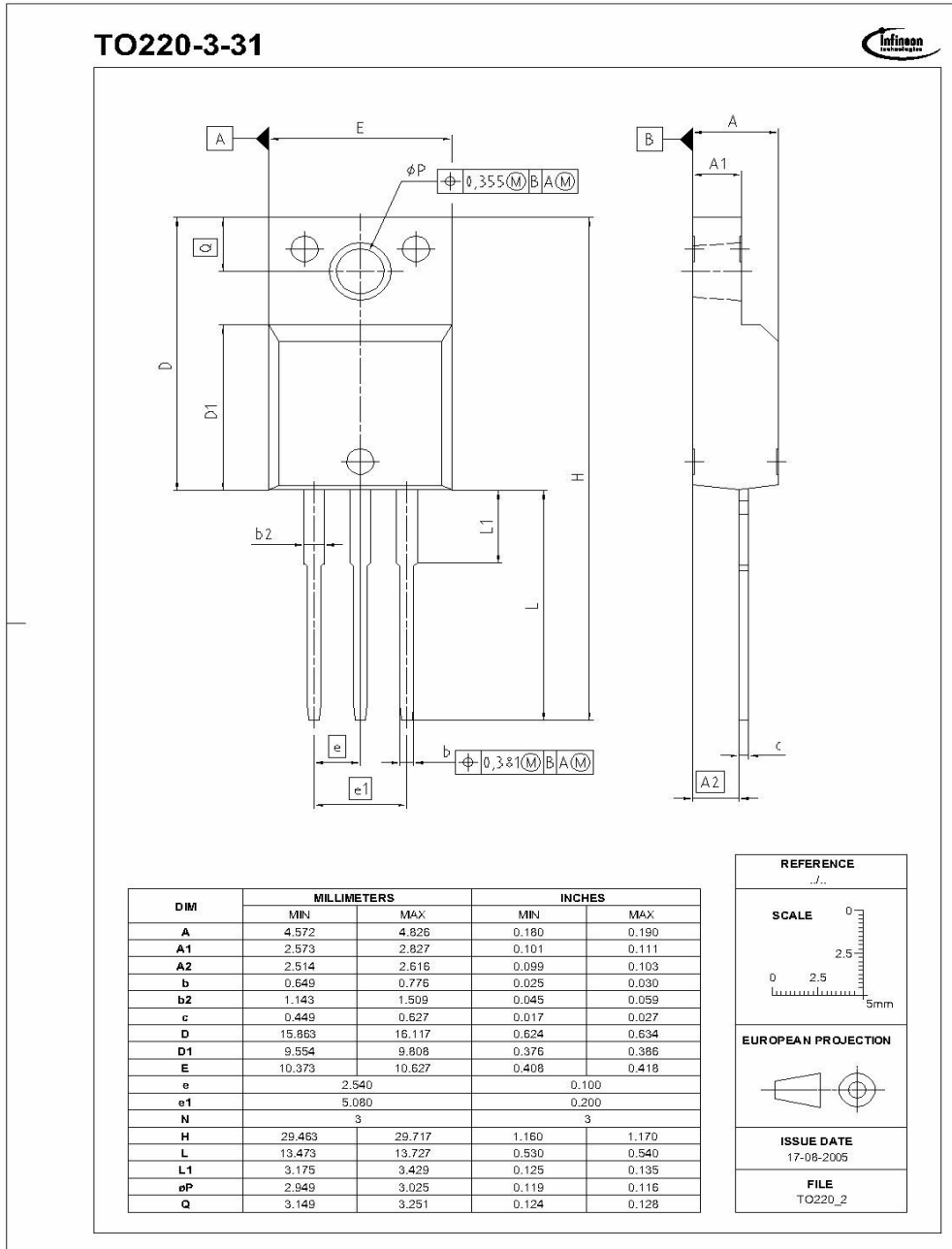

Dimensions in mm

**Published by**  
**Infineon Technologies AG**  
**D-81726 München, Germany**

**© Infineon Technologies AG 2006**  
**All Rights Reserved.**

**Attention please!**

The information herein is given to describe certain components and shall not be considered as warranted characteristics.

Terms of delivery and rights to technical change reserved.

We hereby disclaim any and all warranties, including but not limited to warranties of non-infringement, regarding circuits, descriptions and charts stated herein.

Infineon Technologies is an approved CECC manufacturer.

**Information**

For further information on technology, delivery terms and conditions and prices, please contact your nearest Infineon Technologies office in Germany or our Infineon Technologies representatives worldwide (see address list).

**Warnings**

Due to technical requirements, components may contain dangerous substances.  
For information on the types in question, please contact your nearest Infineon Technologies office.

Infineon Technologies' components may only be used in life-support devices or systems with the expressed written approval of Infineon Technologies if a failure of such components can reasonably be expected to cause the failure of that life-support device or system, or to affect the safety or effectiveness of that device or system. Life support devices or systems are intended to be implanted in the human body, or to support and/or maintain and sustain and/or protect human life. If they fail, it is reasonable to assume that the health of the user or other persons may be endangered.