

# 74LVC08A

## Low-Voltage CMOS Quad 2-Input AND Gate

### With 5 V-Tolerant Inputs

The 74LVC08A is a high performance, quad 2-input AND gate operating from a 1.2 to 3.6 V supply. High impedance TTL compatible inputs significantly reduce current loading to input drivers while TTL compatible outputs offer improved switching noise performance. A  $V_I$  specification of 5.5 V allows 74LVC08A inputs to be safely driven from 5.0 V devices.

Current drive capability is 24 mA at the outputs.

#### Features

- Designed for 1.2 V to 3.6 V  $V_{CC}$  Operation
- 5.0 V Tolerant Inputs – Interface Capability With 5.0 V TTL Logic
- 24 mA Output Sink and Source Capability
- Near Zero Static Supply Current (10  $\mu$ A) Substantially Reduces System Power Requirements
- ESD Performance: Human Body Model >2000 V  
Machine Model >200 V
- These Devices are Pb-Free, Halogen Free/BFR Free and are RoHS Compliant



ON Semiconductor®

[www.onsemi.com](http://www.onsemi.com)

#### MARKING DIAGRAMS

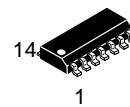

SOIC-14  
D SUFFIX  
CASE 751A

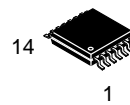
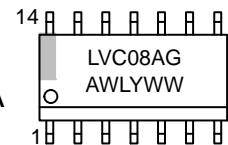

TSSOP-14  
DT SUFFIX  
CASE 948G

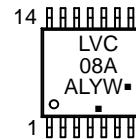

A = Assembly Location  
L, WL = Wafer Lot  
Y = Year  
W, WW = Work Week  
G or ■ = Pb-Free Package  
(Note: Microdot may be in either location)

#### ORDERING INFORMATION

See detailed ordering and shipping information in the package dimensions section on page 6 of this data sheet.

# 74LVC08A

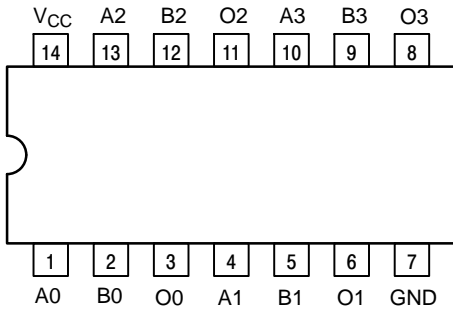

Figure 1. Pinout: 14-Lead (Top View)

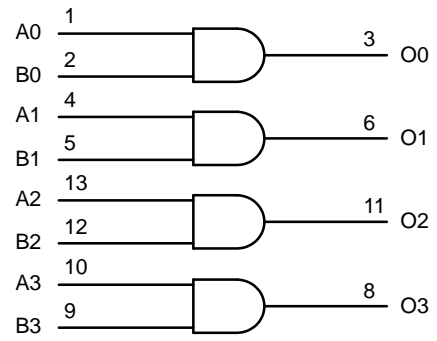

Figure 2. Logic Diagram

## PIN NAMES

Pins	Function
An, Bn	Data Inputs
On	Outputs

## TRUTH TABLE

Inputs		Outputs
An	Bn	On
L	L	L
L	H	L
H	L	L
H	H	H

H = High Voltage Level  
L = Low Voltage Level

For I<sub>CC</sub> reasons, DO NOT FLOAT Inputs

# 74LVC08A

## MAXIMUM RATINGS

Symbol	Parameter	Value	Condition	Unit
$V_{CC}$	DC Supply Voltage	-0.5 to +6.5		V
$V_I$	DC Input Voltage	$-0.5 \leq V_I \leq +6.5$		V
$V_O$	DC Output Voltage	$-0.5 \leq V_O \leq V_{CC} + 0.5$	Output in HIGH or LOW State (Note 1)	V
$I_{IK}$	DC Input Diode Current	-50	$V_I < GND$	mA
$I_{OK}$	DC Output Diode Current	-50	$V_O < GND$	mA
		+50	$V_O > V_{CC}$	mA
$I_O$	DC Output Source/Sink Current	$\pm 50$		mA
$I_{CC}$	DC Supply Current Per Supply Pin	$\pm 100$		mA
$I_{GND}$	DC Ground Current Per Ground Pin	$\pm 100$		mA
$T_{STG}$	Storage Temperature Range	-65 to +150		°C
$T_L$	Lead Temperature, 1 mm from Case for 10 Seconds	$T_L = 260$		°C
$T_J$	Junction Temperature Under Bias	$T_J = 135$		°C
$\theta_{JA}$	Thermal Resistance (Note 2)	SOIC = 85 TSSOP = 100		°C/W
MSL	Moisture Sensitivity		Level 1	

Stresses exceeding those listed in the Maximum Ratings table may damage the device. If any of these limits are exceeded, device functionality should not be assumed, damage may occur and reliability may be affected.

- $I_O$  absolute maximum rating must be observed.
- Measured with minimum pad spacing on an FR4 board, using 10 mm-by-1 inch, 2 ounce copper trace no air flow.

## RECOMMENDED OPERATING CONDITIONS

Symbol	Parameter	Min	Typ	Max	Units
$V_{CC}$	Supply Voltage Operating Functional	1.65 1.2		3.6 3.6	V
$V_I$	Input Voltage	0		5.5	V
$V_O$	Output Voltage HIGH or LOW State 3-State	0 0		$V_{CC}$ 5.5	V
$I_{OH}$	HIGH Level Output Current $V_{CC} = 3.0\text{ V} - 3.6\text{ V}$ $V_{CC} = 2.7\text{ V} - 3.0\text{ V}$			-24 -12	mA
$I_{OL}$	LOW Level Output Current $V_{CC} = 3.0\text{ V} - 3.6\text{ V}$ $V_{CC} = 2.7\text{ V} - 3.0\text{ V}$			24 12	mA
$T_A$	Operating Free-Air Temperature	-40		+125	°C
$\Delta t/\Delta V$	Input Transition Rise or Fall Rate $V_{CC} = 1.65\text{ V to } 2.7\text{ V}$ $V_{CC} = 2.7\text{ V to } 3.6\text{ V}$	0 0		20 10	ns/V

Functional operation above the stresses listed in the Recommended Operating Ranges is not implied. Extended exposure to stresses beyond the Recommended Operating Ranges limits may affect device reliability.

# 74LVC08A

## DC ELECTRICAL CHARACTERISTICS

Symbol	Parameter	Conditions	-40°C to +85°C			-40°C to +125°C			Unit
			Min	Typ (Note 3)	Max	Min	Typ (Note 3)	Max	
V <sub>IH</sub>	HIGH-level input voltage	V <sub>CC</sub> = 1.2 V	1.08	-	-	1.08	-	-	V
		V <sub>CC</sub> = 1.65 V to 1.95 V	0.65 x V <sub>CC</sub>	-	-	0.65 x V <sub>CC</sub>	-	-	
		V <sub>CC</sub> = 2.3 V to 2.7 V	1.7	-	-	1.7	-	-	
		V <sub>CC</sub> = 2.7 V to 3.6 V	2.0	-	-	2.0	-	-	
V <sub>IL</sub>	LOW-level input voltage	V <sub>CC</sub> = 1.2 V	-	-	0.12	-	-	0.12	V
		V <sub>CC</sub> = 1.65 V to 1.95 V	-	-	0.35 x V <sub>CC</sub>	-	-	0.35 x V <sub>CC</sub>	
		V <sub>CC</sub> = 2.3 V to 2.7 V	-	-	0.7	-	-	0.7	
		V <sub>CC</sub> = 2.7 V to 3.6 V	-	-	0.8	-	-	0.8	
V <sub>OH</sub>	HIGH-level output voltage	V <sub>I</sub> = V <sub>IH</sub> or V <sub>IL</sub>							V
		I <sub>O</sub> = -100 μA; V <sub>CC</sub> = 1.65 V to 3.6 V	V <sub>CC</sub> - 0.2	-	-	V <sub>CC</sub> - 0.3	-	-	
		I <sub>O</sub> = -4 mA; V <sub>CC</sub> = 1.65 V	1.2	-	-	1.05	-	-	
		I <sub>O</sub> = -8 mA; V <sub>CC</sub> = 2.3 V	1.8	-	-	1.65	-	-	
		I <sub>O</sub> = -12 mA; V <sub>CC</sub> = 2.7 V	2.2	-	-	2.05	-	-	
		I <sub>O</sub> = -18 mA; V <sub>CC</sub> = 3.0 V	2.4	-	-	2.25	-	-	
		I <sub>O</sub> = -24 mA; V <sub>CC</sub> = 3.0 V	2.2	-	-	2.0	-	-	
V <sub>OL</sub>	LOW-level output voltage	V <sub>I</sub> = V <sub>IH</sub> or V <sub>IL</sub>							V
		I <sub>O</sub> = 100 μA; V <sub>CC</sub> = 1.65 V to 3.6 V	-	-	0.2	-	-	0.3	
		I <sub>O</sub> = 4 mA; V <sub>CC</sub> = 1.65 V	-	-	0.45	-	-	0.65	
		I <sub>O</sub> = 8 mA; V <sub>CC</sub> = 2.3 V	-	-	0.6	-	-	0.8	
		I <sub>O</sub> = 12 mA; V <sub>CC</sub> = 2.7 V	-	-	0.4	-	-	0.6	
		I <sub>O</sub> = -24 mA; V <sub>CC</sub> = 3.0 V	-	-	0.55	-	-	0.8	
I <sub>I</sub>	Input leakage current	V <sub>I</sub> = 5.5V or GND; V <sub>CC</sub> = 3.6 V	-	±0.1	±5	-	±0.1	±20	μA
I <sub>OFF</sub>	Power-off leakage current	V <sub>I</sub> or V <sub>O</sub> = 5.5 V; V <sub>CC</sub> = 0.0 V	-	±0.1	±10	-	±0.1	±20	μA
I <sub>CC</sub>	Supply current	V <sub>I</sub> = V <sub>CC</sub> or GND; I <sub>O</sub> = 0 A; V <sub>CC</sub> = 3.6 V	-	0.1	10	-	0.1	40	μA
ΔI <sub>CC</sub>	Additional supply current	per input pin; V <sub>I</sub> = V <sub>CC</sub> - 0.6 V; I <sub>O</sub> = 0 A; V <sub>CC</sub> = 2.7 V to 3.6 V	-	5	500	-	5	5000	μA

Product parametric performance is indicated in the Electrical Characteristics for the listed test conditions, unless otherwise noted. Product performance may not be indicated by the Electrical Characteristics if operated under different conditions.

3. All typical values are measured at T<sub>A</sub> = 25°C and V<sub>CC</sub> = 3.3 V, unless stated otherwise.

# 74LVC08A

## AC ELECTRICAL CHARACTERISTICS ( $t_R = t_F = 2.5$ ns)

Symbol	Parameter	Conditions	-40°C to +85°C			-40°C to +125°C			Unit
			Min	Typ <sup>1</sup>	Max	Min	Typ <sup>1</sup>	Max	
$t_{pd}$	Propagation Delay (Note 5)	$V_{CC} = 1.2$ V	–	11.0	–	–	–	–	ns
		$V_{CC} = 1.65$ V to $1.95$ V	0.5	4.2	9.0	0.5	–	10.4	ns
		$V_{CC} = 2.3$ V to $2.7$ V	1.0	2.5	6.9	1.0	–	8.0	ns
		$V_{CC} = 2.7$ V	1.5	2.5	4.8	1.5	–	5.6	ns
		$V_{CC} = 3.0$ V to $3.6$ V	1.0	2.3	4.1	1.0	–	4.8	ns
$t_{sk(0)}$	Output Skew Time (Note 6)	$V_{CC} = 3.0$ V to $3.6$ V	–	–	1.0	–	–	1.5	ns

Product parametric performance is indicated in the Electrical Characteristics for the listed test conditions, unless otherwise noted. Product performance may not be indicated by the Electrical Characteristics if operated under different conditions.

4. Typical values are measured at  $T_A = 25^\circ\text{C}$  and  $V_{CC} = 3.3$  V, unless stated otherwise.

5.  $t_{pd}$  is the same as  $t_{PLH}$  and  $t_{PHL}$ .

6. Skew is defined as the absolute value of the difference between the actual propagation delay for any two separate outputs of the same device. The specification applies to any outputs switching in the same direction, either HIGH-to-LOW ( $t_{OSHL}$ ) or LOW-to-HIGH ( $t_{OSLH}$ ); parameter guaranteed by design.

## DYNAMIC SWITCHING CHARACTERISTICS

Symbol	Characteristic	Condition	$T_A = +25^\circ\text{C}$			Unit
			Min	Typ	Max	
$V_{OLP}$	Dynamic LOW Peak Voltage (Note 7)	$V_{CC} = 3.3$ V, $C_L = 50$ pF, $V_{IH} = 3.3$ V, $V_{IL} = 0$ V $V_{CC} = 2.5$ V, $C_L = 30$ pF, $V_{IH} = 2.5$ V, $V_{IL} = 0$ V		0.8 0.6		V
$V_{OLV}$	Dynamic LOW Valley Voltage (Note 7)	$V_{CC} = 3.3$ V, $C_L = 50$ pF, $V_{IH} = 3.3$ V, $V_{IL} = 0$ V $V_{CC} = 2.5$ V, $C_L = 30$ pF, $V_{IH} = 2.5$ V, $V_{IL} = 0$ V		-0.8 -0.6		V

7. Number of outputs defined as "n". Measured with "n-1" outputs switching from HIGH-to-LOW or LOW-to-HIGH. The remaining output is measured in the LOW state.

## CAPACITIVE CHARACTERISTICS

Symbol	Parameter	Condition	Typical	Unit
$C_{IN}$	Input Capacitance	$V_{CC} = 3.3$ V, $V_I = 0$ V or $V_{CC}$	4.0	pF
$C_{OUT}$	Output Capacitance	$V_{CC} = 3.3$ V, $V_I = 0$ V or $V_{CC}$	5.0	pF
$C_{PD}$	Power Dissipation Capacitance (Note 8)	Per input; $V_I = \text{GND}$ or $V_{CC}$		pF
		$V_{CC} = 1.65$ V to $1.95$ V	4.4	
		$V_{CC} = 2.3$ V to $2.7$ V	7.7	
		$V_{CC} = 3.0$ V to $3.6$ V	10.5	

8.  $C_{PD}$  is used to determine the dynamic power dissipation ( $P_D$  in  $\mu\text{W}$ ).

$P_D = C_{PD} \times V_{CC}^2 \times f_i \times N + \sum (C_L \times V_{CC}^2 \times f_o)$  where:

$f_i$  = input frequency in MHz;  $f_o$  = output frequency in MHz

$C_L$  = output load capacitance in pF  $V_{CC}$  = supply voltage in Volts

$N$  = number of outputs switching

$\sum(C_L \times V_{CC}^2 \times f_o)$  = sum of the outputs.

# 74LVC08A

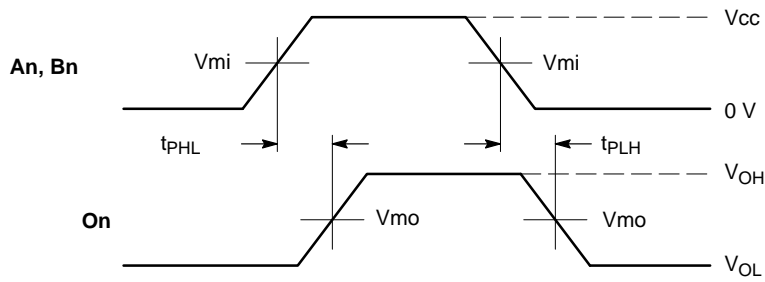

**WAVEFORM 1 – PROPAGATION DELAYS**

$t_R = t_F = 2.5 \text{ ns}$ , 10% to 90%;  $f = 1 \text{ MHz}$ ;  $t_W = 500 \text{ ns}$

Symbol	V <sub>CC</sub>		
	3.3 V ± 0.3 V	2.7 V	V <sub>CC</sub> < 2.7 V
V <sub>mi</sub>	1.5 V	1.5 V	V <sub>CC</sub> /2
V <sub>mo</sub>	1.5 V	1.5 V	V <sub>CC</sub> /2

**Figure 3. AC Waveforms**

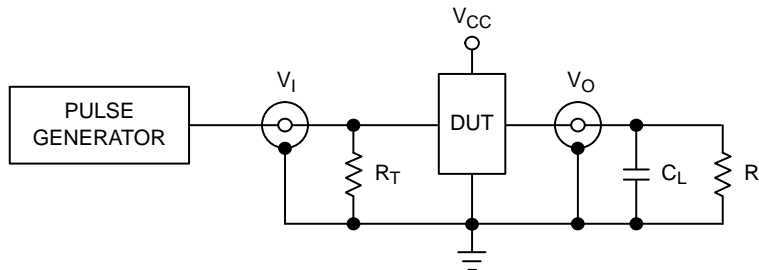

$C_L$  includes jig and probe capacitance  
 $R_T = Z_{OUT}$  of pulse generator (typically 50  $\Omega$ )

Supply Voltage	Input		Load	
	V <sub>CC</sub> (V)	V <sub>I</sub> , t <sub>r</sub> , t <sub>f</sub>	C <sub>L</sub>	R <sub>L</sub>
1.2	V <sub>CC</sub>	≤ 2 ns	30 pF	1 k $\Omega$
1.65 – 1.95	V <sub>CC</sub>	≤ 2 ns	30 pF	1 k $\Omega$
2.3 – 2.7	V <sub>CC</sub>	≤ 2 ns	30 pF	500 $\Omega$
2.7	2.7 V	≤ 2.5 ns	50 pF	500 $\Omega$
3 – 3.6	2.7 V	≤ 2.5 ns	50 pF	500 $\Omega$

**Figure 4. Test Circuit**

## ORDERING INFORMATION

Device	Package	Shipping†
74LVC08ADR2G	SOIC-14 (Pb-Free)	2500 / Tape & Reel
74LVC08ADTR2G	TSSOP-14 (Pb-Free)	2500 / Tape & Reel

†For information on tape and reel specifications, including part orientation and tape sizes, please refer to our Tape and Reel Packaging Specifications Brochure, BRD8011/D.

# 74LVC08A

## PACKAGE DIMENSIONS

TSSOP-14  
CASE 948G  
ISSUE B

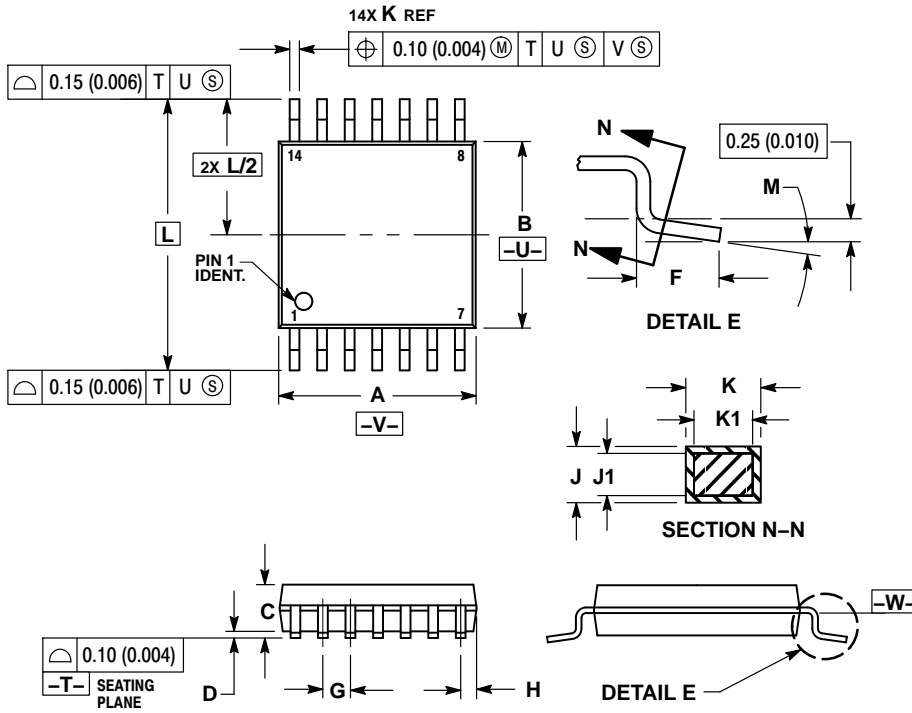

### NOTES:

1. DIMENSIONING AND TOLERANCING PER ANSI Y14.5M, 1982.
2. CONTROLLING DIMENSION: MILLIMETER.
3. DIMENSION A DOES NOT INCLUDE MOLD FLASH, PROTRUSIONS OR GATE BURRS. MOLD FLASH OR GATE BURRS SHALL NOT EXCEED 0.15 (0.006) PER SIDE.
4. DIMENSION B DOES NOT INCLUDE INTERLEAD FLASH OR PROTRUSION. INTERLEAD FLASH OR PROTRUSION SHALL NOT EXCEED 0.25 (0.010) PER SIDE.
5. DIMENSION K DOES NOT INCLUDE DAMBAR PROTRUSION. ALLOWABLE DAMBAR PROTRUSION SHALL BE 0.08 (0.003) TOTAL IN EXCESS OF THE K DIMENSION AT MAXIMUM MATERIAL CONDITION.
6. TERMINAL NUMBERS ARE SHOWN FOR REFERENCE ONLY.
7. DIMENSION A AND B ARE TO BE DETERMINED AT DATUM PLANE  $-W-$ .

DIM	MILLIMETERS		INCHES	
	MIN	MAX	MIN	MAX
A	4.90	5.10	0.193	0.200
B	4.30	4.50	0.169	0.177
C	---	1.20	---	0.047
D	0.05	0.15	0.002	0.006
F	0.50	0.75	0.020	0.030
G	0.65 BSC		0.026 BSC	
H	0.50	0.60	0.020	0.024
J	0.09	0.20	0.004	0.008
J1	0.09	0.16	0.004	0.006
K	0.19	0.30	0.007	0.012
K1	0.19	0.25	0.007	0.010
L	6.40 BSC		0.252 BSC	
M	0°	8°	0°	8°

### SOLDERING FOOTPRINT\*

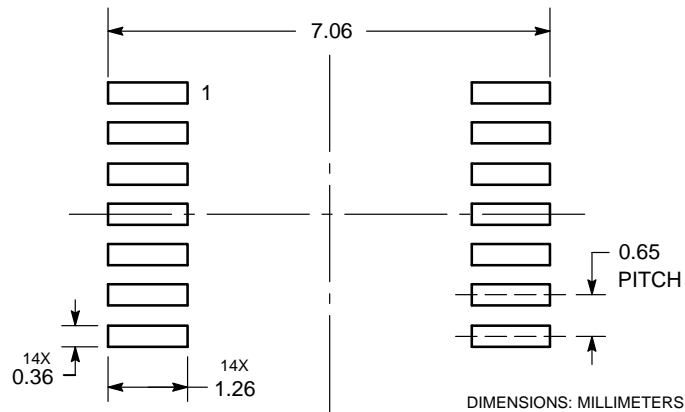

\*For additional information on our Pb-Free strategy and soldering details, please download the ON Semiconductor Soldering and Mounting Techniques Reference Manual, SOLDERRM/D.

# 74LVC08A

## PACKAGE DIMENSIONS

### SOIC-14 NB CASE 751A-03 ISSUE K

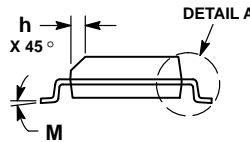
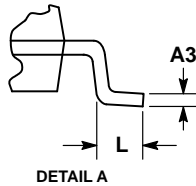
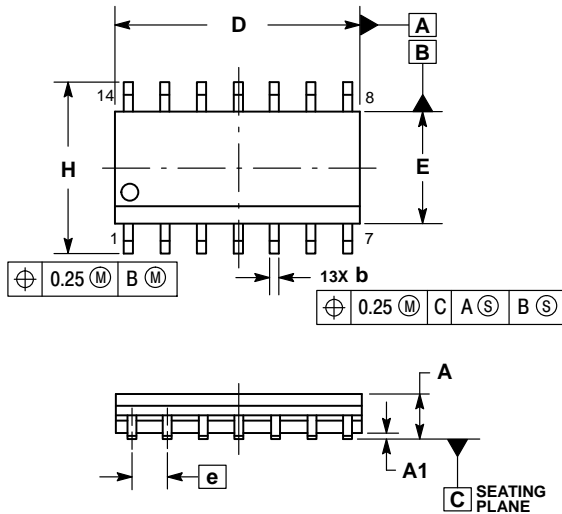

**NOTES:**

1. DIMENSIONING AND TOLERANCING PER ASME Y14.5M, 1994.
2. CONTROLLING DIMENSION: MILLIMETERS.
3. DIMENSION b DOES NOT INCLUDE DAMBAR PROTRUSION. ALLOWABLE PROTRUSION SHALL BE 0.13 TOTAL IN EXCESS OF AT MAXIMUM MATERIAL CONDITION.
4. DIMENSIONS D AND E DO NOT INCLUDE MOLD PROTRUSIONS.
5. MAXIMUM MOLD PROTRUSION 0.15 PER SIDE.

DIM	MILLIMETERS		INCHES	
	MIN	MAX	MIN	MAX
A	1.35	1.75	0.054	0.068
A1	0.10	0.25	0.004	0.010
A3	0.19	0.25	0.008	0.010
b	0.35	0.49	0.014	0.019
D	8.55	8.75	0.337	0.344
E	3.80	4.00	0.150	0.157
e	1.27 BSC		0.050 BSC	
H	5.80	6.20	0.228	0.244
h	0.25	0.50	0.010	0.019
L	0.40	1.25	0.016	0.049
M	0°	7°	0°	7°

### SOLDERING FOOTPRINT\*

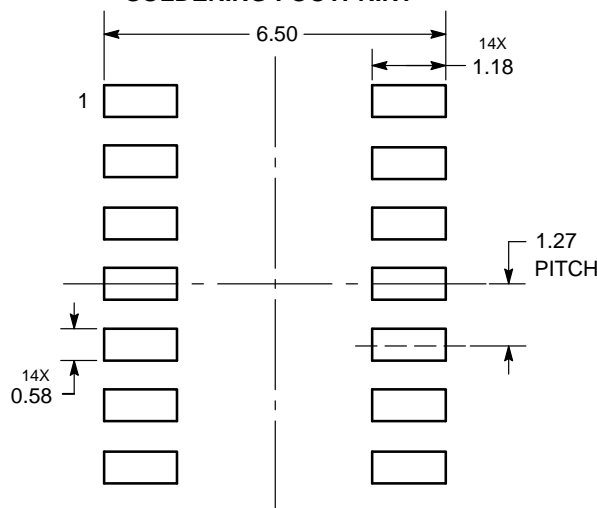

DIMENSIONS: MILLIMETERS

\*For additional information on our Pb-Free strategy and soldering details, please download the ON Semiconductor Soldering and Mounting Techniques Reference Manual, SOLDERRM/D.

ON Semiconductor and the are registered trademarks of Semiconductor Components Industries, LLC (SCILLC) or its subsidiaries in the United States and/or other countries. SCILLC owns the rights to a number of patents, trademarks, copyrights, trade secrets, and other intellectual property. A listing of SCILLC's product/patent coverage may be accessed at [www.onsemi.com/site/pdf/Patent-Marking.pdf](http://www.onsemi.com/site/pdf/Patent-Marking.pdf). SCILLC reserves the right to make changes without further notice to any products herein. SCILLC makes no warranty, representation or guarantee regarding the suitability of its products for any particular purpose, nor does SCILLC assume any liability arising out of the application or use of any product or circuit, and specifically disclaims any and all liability, including without limitation special, consequential or incidental damages. "Typical" parameters which may be provided in SCILLC data sheets and/or specifications can and do vary in different applications and actual performance may vary over time. All operating parameters, including "Typicals" must be validated for each customer application by customer's technical experts. SCILLC does not convey any license under its patent rights nor the rights of others. SCILLC products are not designed, intended, or authorized for use as components in systems intended for surgical implant into the body, or other applications intended to support or sustain life, or for any other application in which the failure of the SCILLC product could create a situation where personal injury or death may occur. Should Buyer purchase or use SCILLC products for any such unintended or unauthorized application, Buyer shall indemnify and hold SCILLC and its officers, employees, subsidiaries, affiliates, and distributors harmless against all claims, costs, damages, and expenses, and reasonable attorney fees arising out of, directly or indirectly, any claim of personal injury or death associated with such unintended or unauthorized use, even if such claim alleges that SCILLC was negligent regarding the design or manufacture of the part. SCILLC is an Equal Opportunity/Affirmative Action Employer. This literature is subject to all applicable copyright laws and is not for resale in any manner.

### PUBLICATION ORDERING INFORMATION

**LITERATURE FULFILLMENT:**  
Literature Distribution Center for ON Semiconductor  
19521 E. 32nd Pkwy, Aurora, Colorado 80011 USA  
**Phone:** 303-675-2175 or 800-344-3860 Toll Free USA/Canada  
**Fax:** 303-675-2176 or 800-344-3867 Toll Free USA/Canada  
**Email:** [orderlit@onsemi.com](mailto:orderlit@onsemi.com)

**N. American Technical Support:** 800-282-9855 Toll Free  
USA/Canada  
**Europe, Middle East and Africa Technical Support:**  
Phone: 421 33 790 2910  
**Japan Customer Focus Center**  
Phone: 81-3-5817-1050

**ON Semiconductor Website:** [www.onsemi.com](http://www.onsemi.com)  
**Order Literature:** <http://www.onsemi.com/orderlit>  
For additional information, please contact your local Sales Representative