

SERIES: V78-2000 | **DESCRIPTION:** NON-ISOLATED SWITCHING REGULATOR

FEATURES

- 2 A current output
- extremely high efficiency up to 92%
- no heat sink required
- pin compatible to LM78XX linear regulators
- available in straight and right angle SIP packages
- low ripple and noise
- short circuit protection, thermal shutdown
- wide temperature (-40~85°C)

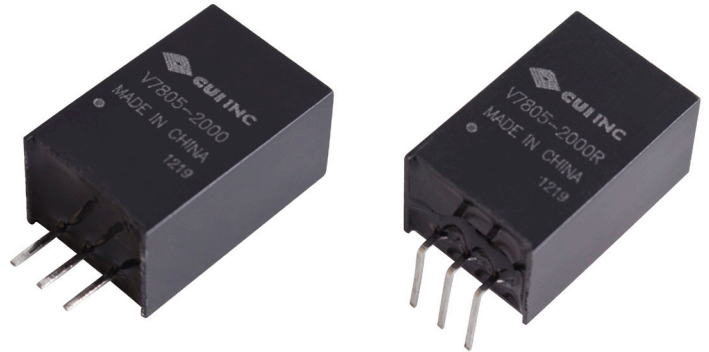

MODEL	input voltage		output voltage (Vdc)	output current max (mA)	output power max (W)	ripple and noise ¹ max (mVp-p)	efficiency	
	typ (Vdc)	range (Vdc)					Vin min (%)	Vin max (%)
V7802-2000*	12	4.75~18	2.5	2,000	5	45	85	83
V7803-2000	12	4.75~18	3.3	2,000	6.6	45	87	86
V7805-2000	12	6.5~18	5	2,000	10	45	91	88
V7806-2000	12	8~18	6.5	2,000	13	45	92	91

Notes: 1. ripple and noise are measured at 20 MHz BW
*. Discontinued

PART NUMBER KEY

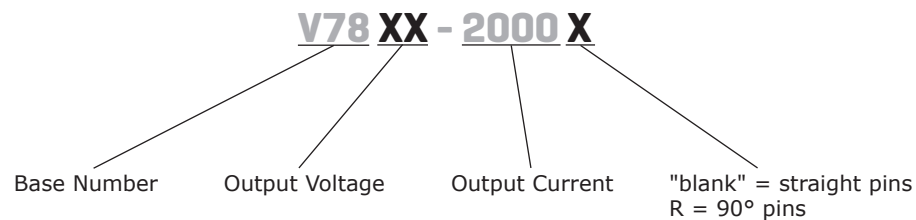

INPUT

parameter	conditions/description	min	typ	max	units
operating input voltage	2.5 and 3.3 V outputs	4.75	12	18	Vdc
	5 V output	7	12	18	Vdc
	6.5 V output	8.5	12	18	Vdc

OUTPUT

parameter	conditions/description	min	typ	max	units
line regulation	Vin = min ~ max, at full load		±0.5	±0.75	%
load regulation	measured from 10% load to full load		±0.5	±1.0	%
voltage accuracy	100% load		±2	±3	%
switching frequency	100% load, input voltage range	300	340	380	kHz
temperature coefficient			±0.03		%/°C

PROTECTIONS

parameter	conditions/description	min	typ	max	units
short circuit protection	continuous, automatic recovery				
thermal shutdown	internal IC junction		150		°C

SAFETY AND COMPLIANCE

parameter	conditions/description	min	typ	max	units
EMI/EMC	EN 55022 class B, EN 61000-4-2 level 3 6kV / 8kV perf. criteria B				
MTBF		2,000,000			hours
RoHS	2011/65/EU				

ENVIRONMENTAL

parameter	conditions/description	min	typ	max	units
operating temperature		-40		85	°C
storage temperature		-55		125	°C
case temperature				100	°C
storage humidity	non-condensing			95	%
temperature rise	at full load		25		°C
lead temperature	1.5 mm from case for 10 seconds			300	°C

DERATING CURVES

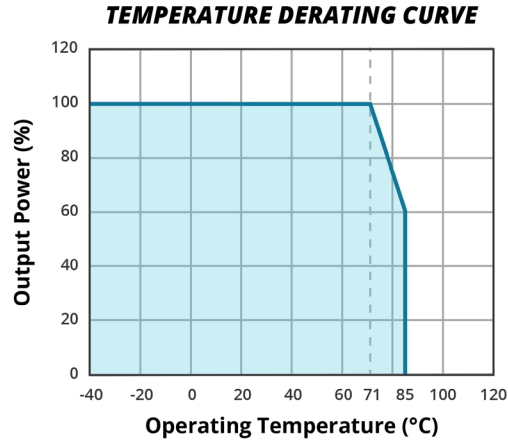

MECHANICAL

parameter	conditions/description	min	typ	max	units
dimensions	0.689 x 0.354 x 0.453 (11.50 x 9.00 x 17.50 mm)				inch
case material	plastic (UL94-V0)				
weight			4.0		g

MECHANICAL DRAWING

units: mm [inches]
 tolerance: ±0.25 [±0.010]
 pin section tolerance: ±0.10 mm [±0.004]

V78XX-2000

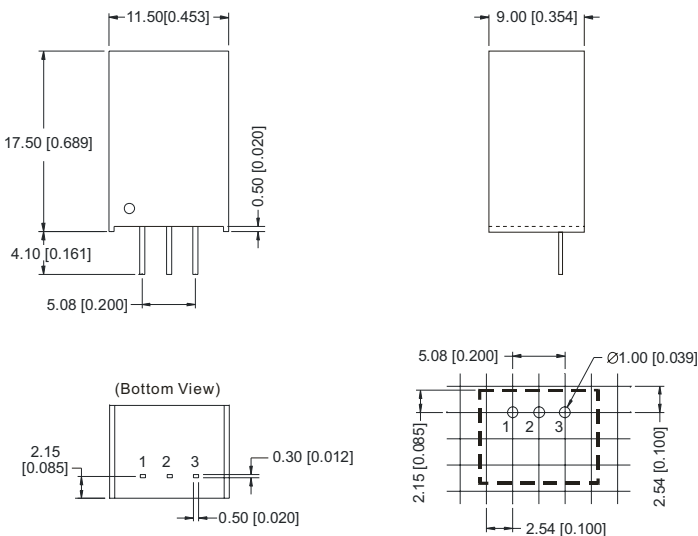

V78XX-2000R

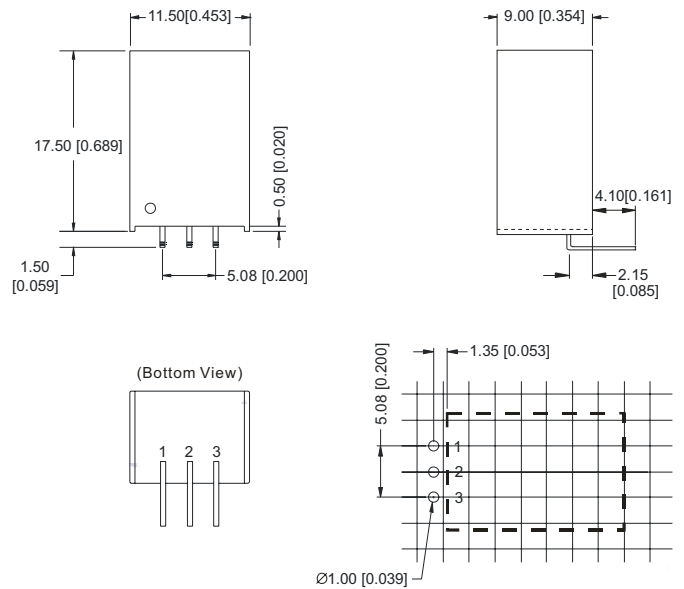

PIN CONNECTIONS	
PIN	FUNCTION
1	+Vin
2	GND
3	+Vo

EXTERNAL CAPACITOR TABLE

Part Number	C1 (Ceramic capacitor)	C2 (Ceramic capacitor)
V7802-2000	10 μ F/25V	22 μ F/6.3V
V7803-2000	10 μ F/25V	22 μ F/6.3V
V7805-2000	10 μ F/25V	22 μ F/16V
V7806-2000	10 μ F/25V	22 μ F/16V

TYPICAL APPLICATION CIRCUIT

Positive Output

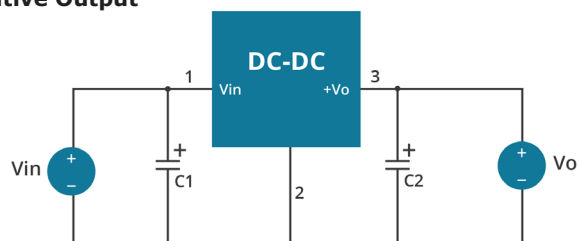

Negative Output

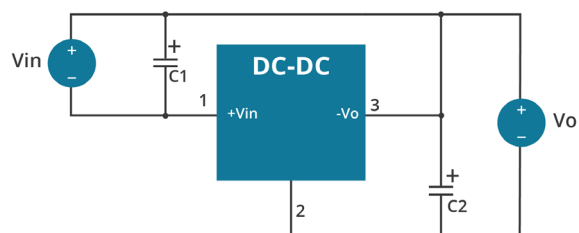

APPLICATION EXAMPLE

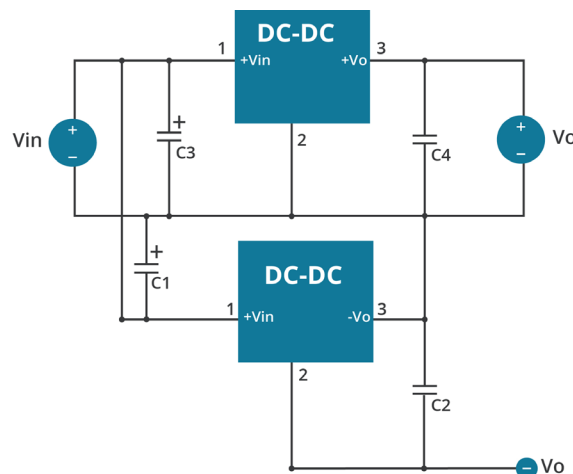

Note:

1. C1 and C2 are required and should be fitted close to the converter pins.
2. The capacitance of C1 and C2 sees external capacitor table, it can be increased properly if required, and tantalum or low ESR electrolytic capacitors may also suffice.
3. No parallel connection or plug and play.

INPUT FILTER CIRCUIT

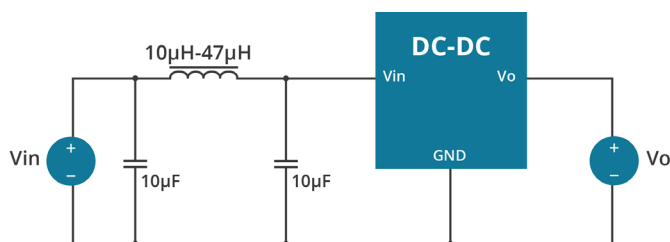

OUTPUT FILTER CIRCUIT

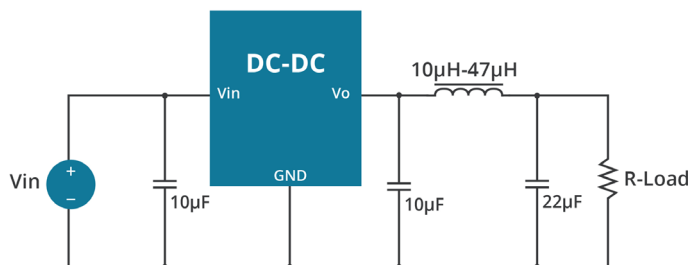

EMC RECOMMENDED CIRCUIT

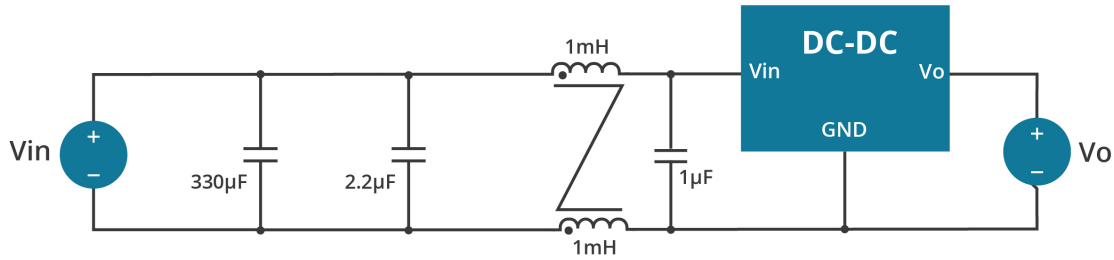

TEST CONFIGURATION

Efficiency and Output Voltage Ripple Test

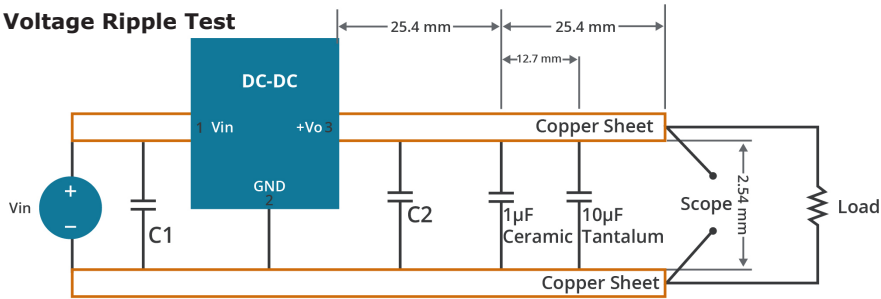

Start-up and Load Transient Response Test

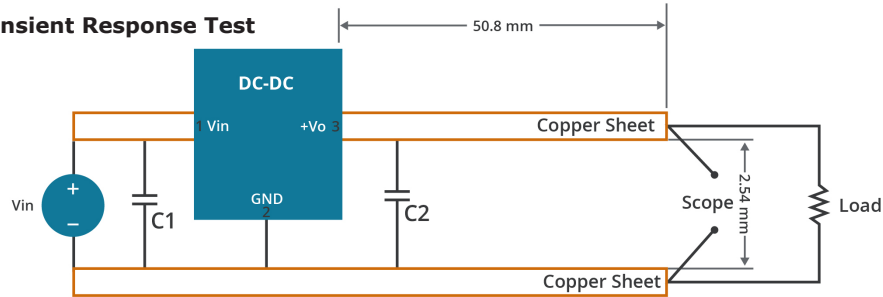

EFFICIENCY AND RIPPLE CURVES

EFFICIENCY VS INPUT VOLTAGE (full load)

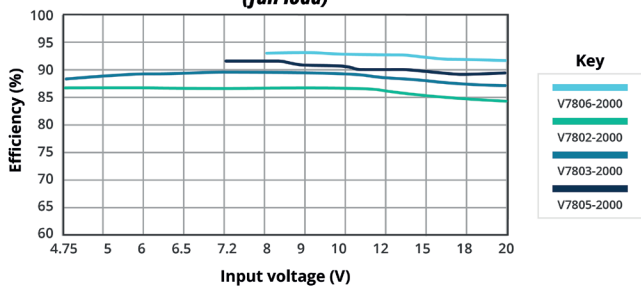

RIPPLE VS OUTPUT LOAD (nominal Vin)

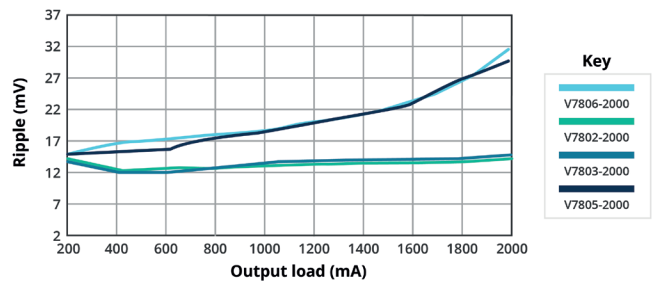

EFFICIENCY VS INPUT VOLTAGE (full load)

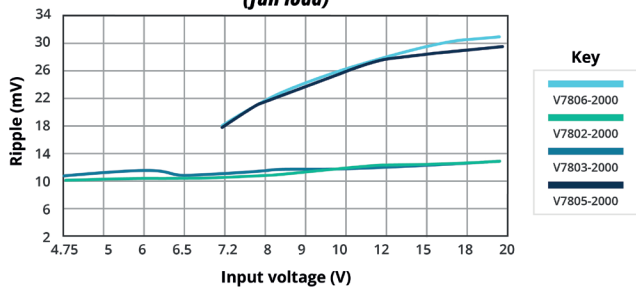

RIPPLE VS OUTPUT LOAD (nominal Vin)

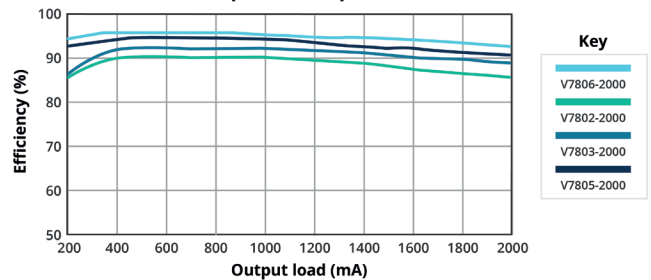

REVISION HISTORY

rev.	description	date
1.0	initial release	06/17/2010
1.01	V-Infinity branding removed	09/06/2012
1.02	updated typical application circuits	09/25/2012
1.03	discontinued model V7802-2000	03/21/2014
1.04	company logo updated	04/14/2021
1.05	derating curve, efficiency curves and circuit figures updated	09/22/2021

The revision history provided is for informational purposes only and is believed to be accurate.



CUI INC
a bel group

Headquarters
20050 SW 112th Ave.
Tualatin, OR 97062
800.275.4899

Fax 503.612.2383
cui.com
techsupport@cui.com

CUI offers a two (2) year limited warranty. Complete warranty information is listed on our website.

CUI reserves the right to make changes to the product at any time without notice. Information provided by CUI is believed to be accurate and reliable. However, no responsibility is assumed by CUI for its use, nor for any infringements of patents or other rights of third parties which may result from its use.

CUI products are not authorized or warranted for use as critical components in equipment that requires an extremely high level of reliability. A critical component is any component of a life support device or system whose failure to perform can be reasonably expected to cause the failure of the life support device or system, or to affect its safety or effectiveness.