

SKiiP 03NAC12T4V1



MiniSKiiP[®]0

3-phase bridge rectifier +
3-phase bridge inverter

SKiiP 03NAC12T4V1

Features

- Trench 4 IGBTs
- Robust and soft freewheeling diodes in CAL technology
- Highly reliable spring contacts for electrical connections
- UL recognised file no. E 63532

Remarks

- V_{CEsat} , V_F = chip level value
- Case temp. limited to $T_C = 125^\circ\text{C}$ max. (for baseplateless modules $T_C = T_S$)
- product rel. results valid for $T_{j \leq 150}$ (recomm. $T_{op} = -40 \dots +150^\circ\text{C}$)
- Temp.Sensor: No basic insulaton to main circuit, max. potential difference 850V to -DC

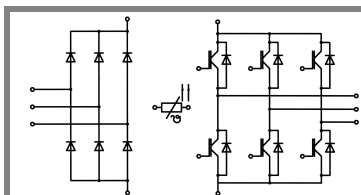

NAC

Absolute Maximum Ratings		$T_S = 25^\circ\text{C}$, unless otherwise specified		
Symbol	Conditions	Values	Units	
IGBT - Inverter				
V_{CES}	$T_s = 25 (70)^\circ\text{C}$	1200	V	
I_C		7,5 (7,5)	A	
I_{CRM}		24	A	
V_{GES}		± 20	V	
T_j		-40...+175	$^\circ\text{C}$	
Diode - Inverter				
I_F	$T_s = 25 (70)^\circ\text{C}$	9 (9)	A	
I_{FRM}		24	A	
T_j		-40...+175	$^\circ\text{C}$	
Diode - Rectifier				
V_{RRM}	$T_s = 70^\circ\text{C}$	1600	V	
I_F		35	A	
I_{FSM}		$t_p = 10 \text{ ms, sin } 180^\circ, T_j = 25^\circ\text{C}$	220	A
i^2t		$t_p = 10 \text{ ms, sin } 180^\circ, T_j = 25^\circ\text{C}$	240	A^2s
T_j		-40...+150	$^\circ\text{C}$	
Module				
I_{tRMS}	per power terminal (20 A / spring)	20	A	
T_{stg}		-40...+125	$^\circ\text{C}$	
V_{isol}	AC, 1 min.	2500	V	

Characteristics		$T_S = 25^\circ\text{C}$, unless otherwise specified			
Symbol	Conditions	min.	typ.	max.	Units
IGBT - Inverter					
V_{CEsat}	$I_{Cnom} = 8 \text{ A}, T_j = 25 (150)^\circ\text{C}$		1,85 (2,25)	2,1 (2,5)	V
$V_{GE(th)}$	$V_{GE} = V_{CE}, I_C = 1 \text{ mA}$	5	5,8	6,5	V
$V_{CE(TO)}$	$T_j = 25 (150)^\circ\text{C}$		0,8 (0,7)	0,9 (0,8)	V
r_T	$T_j = 25 (150)^\circ\text{C}$		131 (194)	150 (213)	$\text{m}\Omega$
C_{ies}	$V_{CE} = 25 \text{ V}, V_{GE} = 0 \text{ V}, f = 1 \text{ MHz}$		0,49		nF
C_{oes}	$V_{CE} = 25 \text{ V}, V_{GE} = 0 \text{ V}, f = 1 \text{ MHz}$		0,05		nF
C_{res}	$V_{CE} = 25 \text{ V}, V_{GE} = 0 \text{ V}, f = 1 \text{ MHz}$		0,03		nF
$R_{th(j-s)}$	per IGBT		1,84		K/W
$t_{d(on)}$	under following conditions		32		ns
t_r	$V_{CC} = 600 \text{ V}, V_{GE} = \pm 15 \text{ V}$		34		ns
$t_{d(off)}$	$I_{Cnom} = 8 \text{ A}, T_j = 150^\circ\text{C}$		295		ns
t_f	$R_{Gon} = R_{Goff} = 47 \Omega$		68		ns
E_{on}	inductive load		0,9		mJ
E_{off}			0,7		mJ
Diode - Inverter					
$V_F = V_{EC}$	$I_{Fnom} = 8 \text{ A}, T_j = 25 (150)^\circ\text{C}$		2,4 (2,45)	2,75 (2,8)	V
$V_{(TO)}$	$T_j = 25 (150)^\circ\text{C}$		1,3 (0,9)	1,5 (1,1)	V
r_T	$T_j = 25 (150)^\circ\text{C}$		138 (194)	156 (213)	$\text{m}\Omega$
$R_{th(j-s)}$	per diode		2,53		K/W
I_{RRM}	under following conditions		7,7		A
Q_{rr}	$I_{Fnom} = 8 \text{ A}, V_R = 600 \text{ V}$		1,23		μC
E_{rr}	$V_{GE} = 0 \text{ V}, T_j = 150^\circ\text{C}$		0,5		mJ
	$di_F/dt = 335 \text{ A}/\mu\text{s}$				
Diode - Rectifier					
V_F	$I_{Fnom} = 15 \text{ A}, T_j = 25^\circ\text{C}$		1,1		V
$V_{(TO)}$	$T_j = 150^\circ\text{C}$		0,8		V
r_T	$T_j = 150^\circ\text{C}$		20		$\text{m}\Omega$
$R_{th(j-s)}$	per diode		1,5		K/W
Temperature Sensor					
R_{ts}	3 %, $T_r = 25 (100)^\circ\text{C}$		1000(1670)		Ω
Mechanical Data					
w			20		g
M_s	Mounting torque	2		2,5	Nm

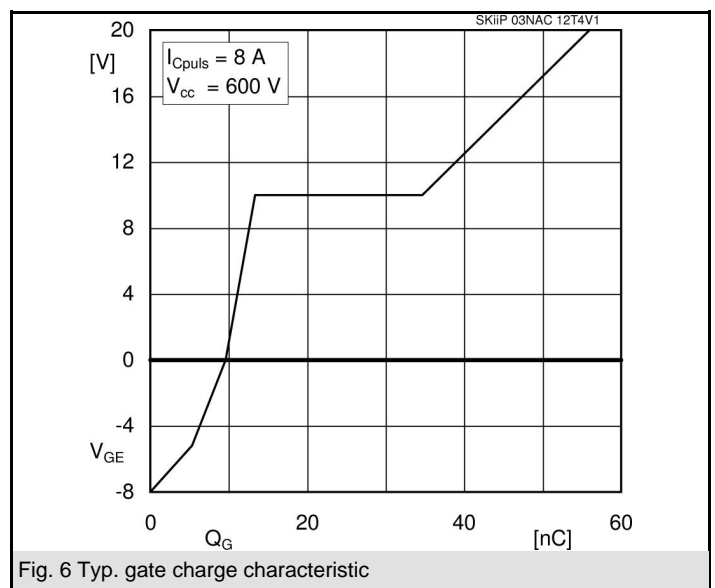
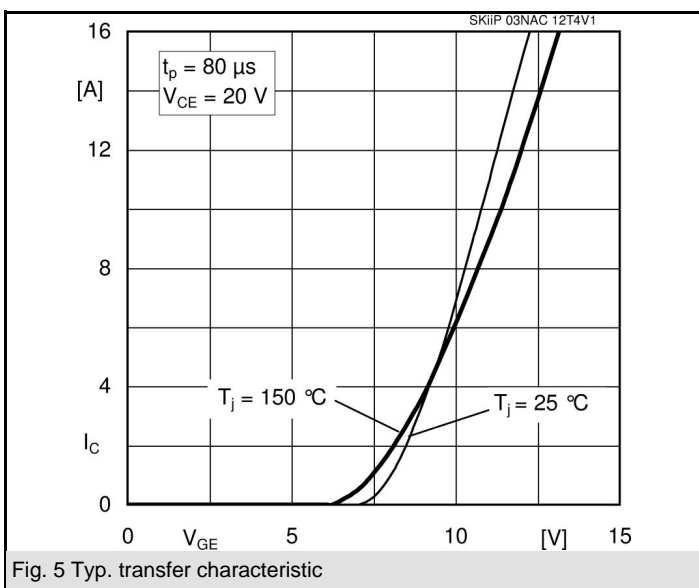
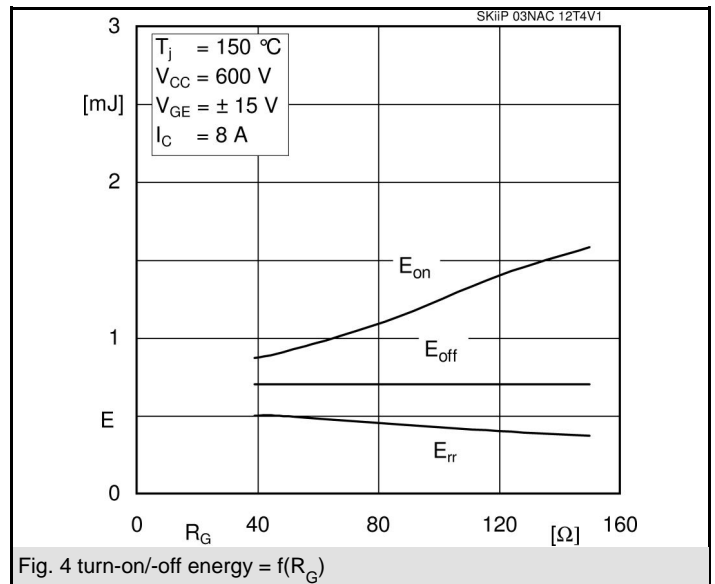
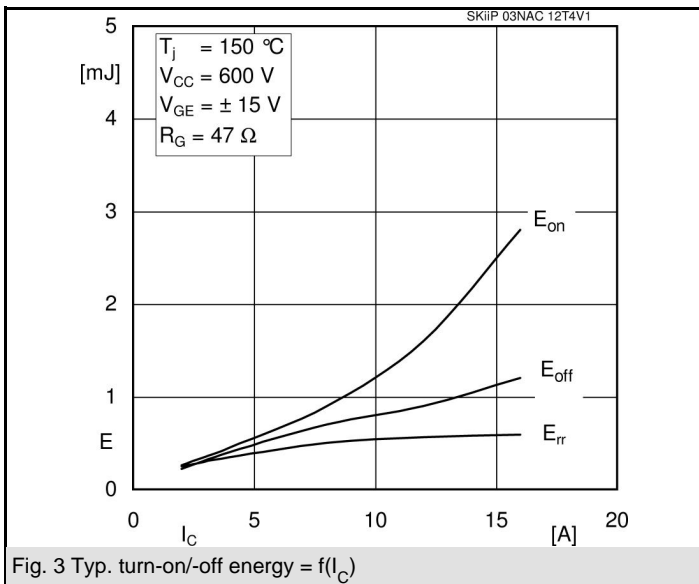
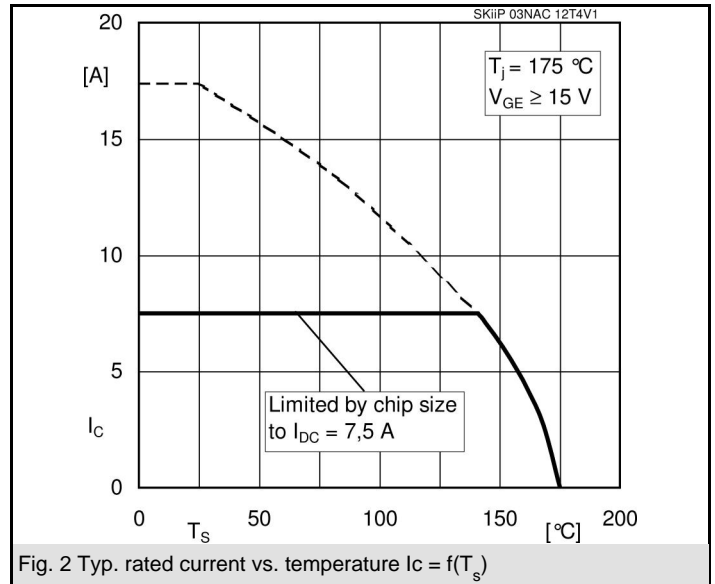
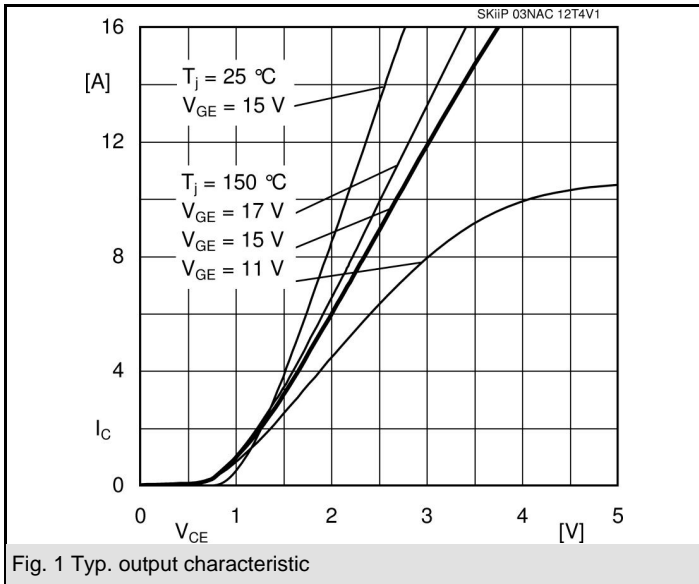

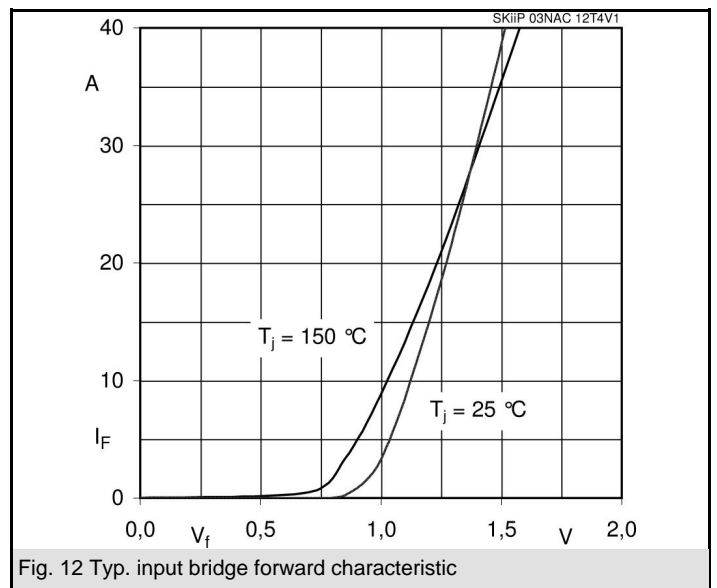
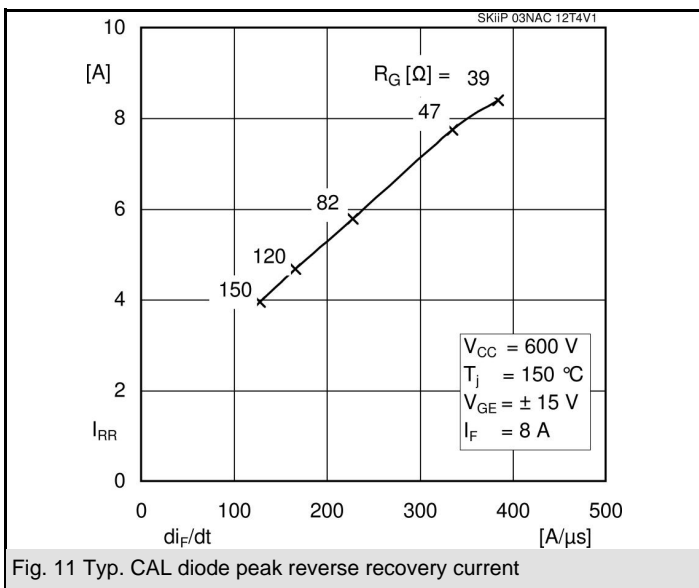
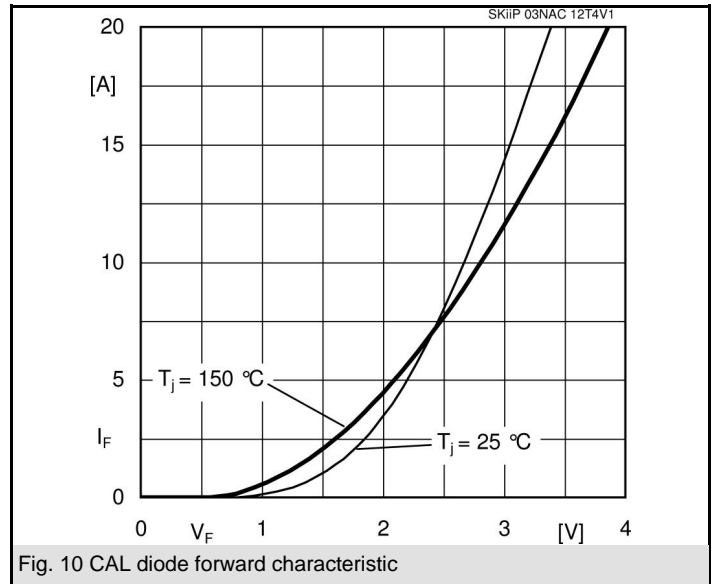
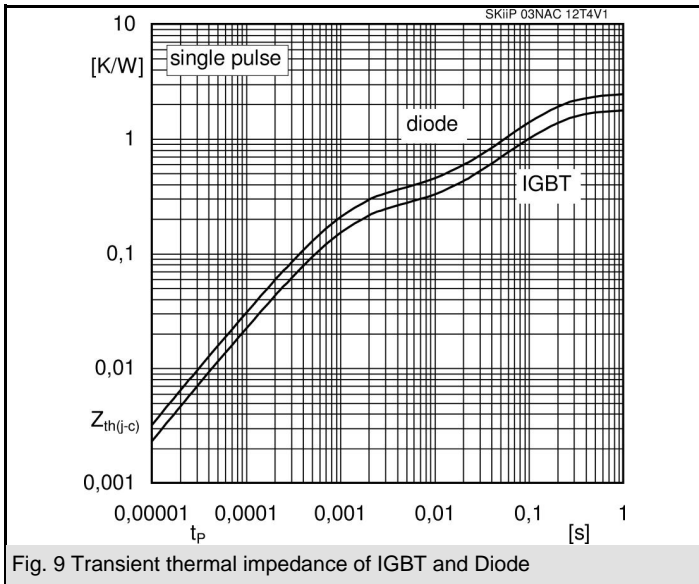
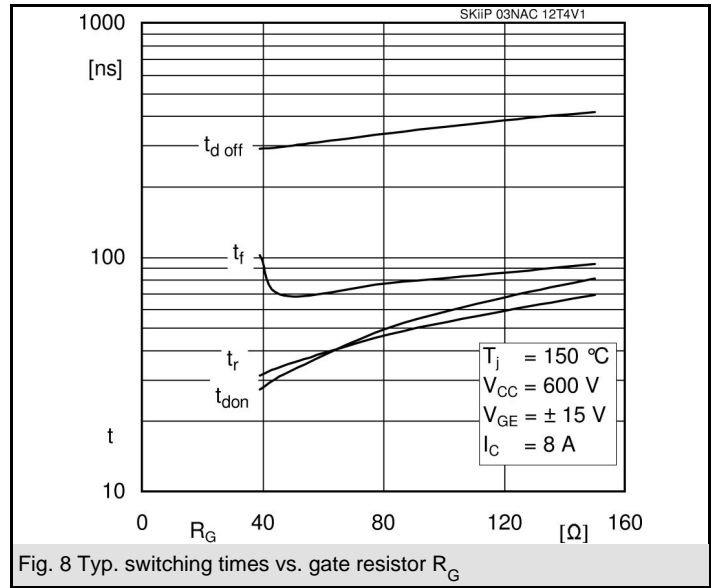
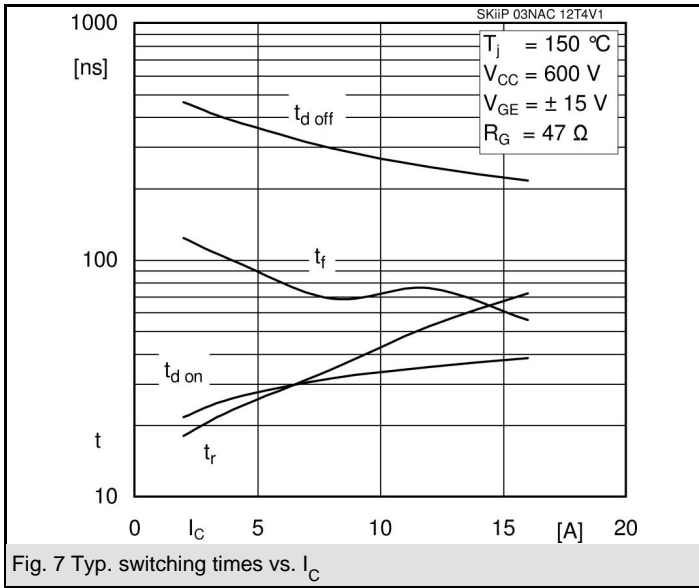

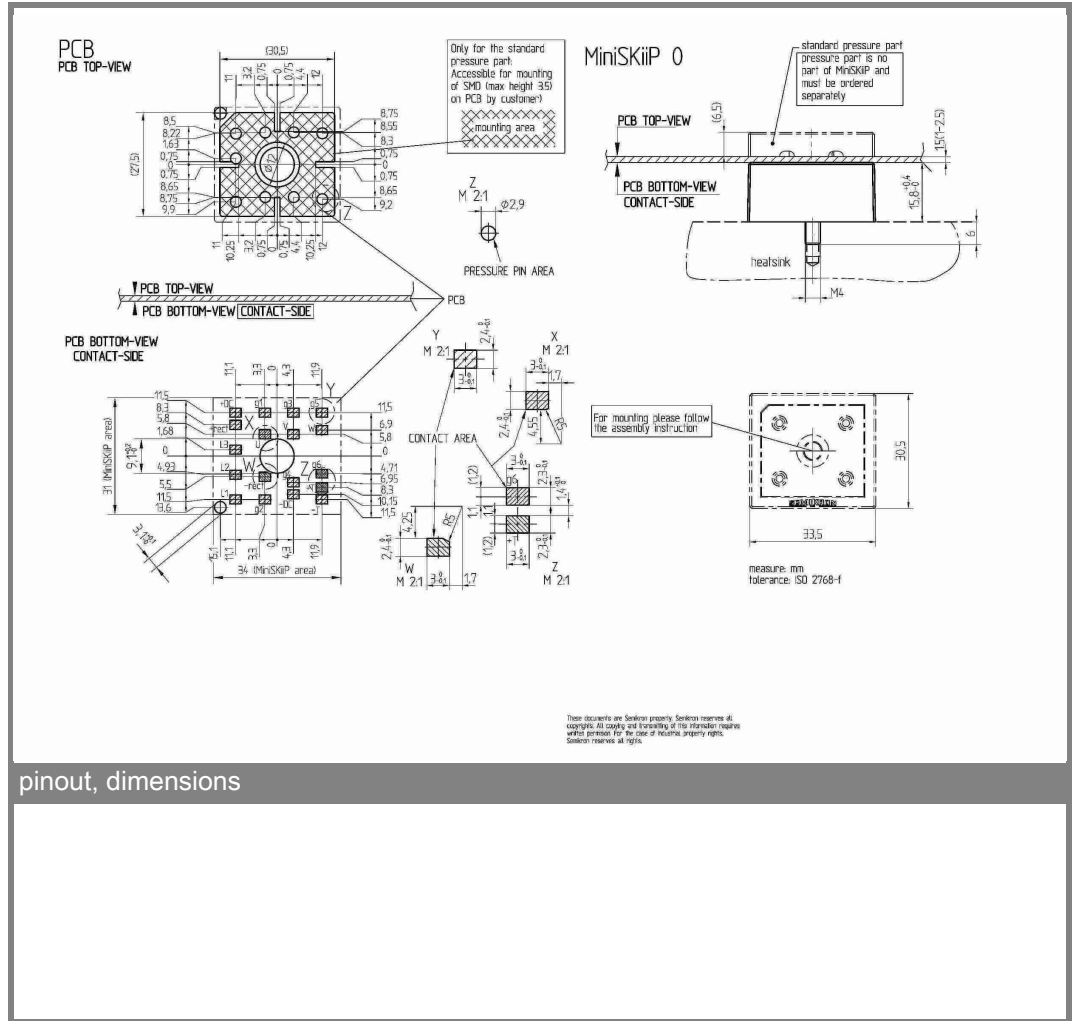
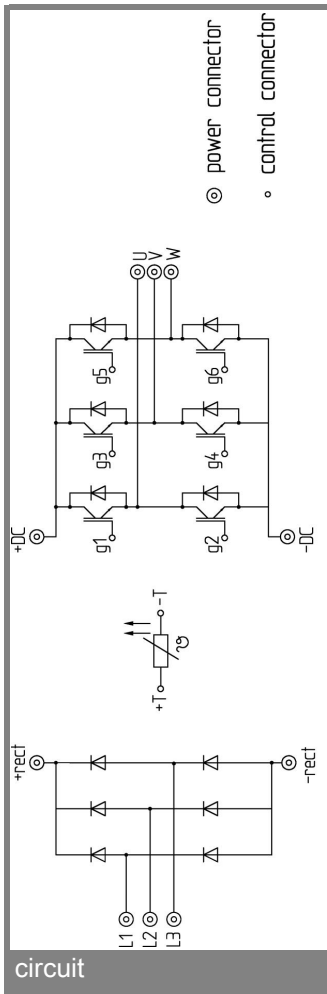

pinout, dimensions

This is an electrostatic discharge sensitive device (ESDS), international standard IEC 60747-1, Chapter IX.

* The specifications of our components may not be considered as an assurance of component characteristics. Components have to be tested for the respective application. Adjustments may be necessary. The use of SEMIKRON products in life support appliances and systems is subject to prior specification and written approval by SEMIKRON. We therefore strongly recommend prior consultation of our personal.