

### Features

- 2μA Ground Current at no Load
- ±2% Output Accuracy
- 500mA Output Current
- 10nA Disable Current ( by option )
- Wide Operating Input Voltage Range: 1.2V to 5.5V
- Dropout Voltage: 0.32V at 500mA/ V<sub>OUT</sub> 3.3V
- Support Fixed Output Voltage 1.2V, 1.5V, 1.6V, 1.8V, 2.5V, 2.8V, 3.0V, 3.3V
- Stable with Ceramic or Tantalum Capacitor
- Current Limit Protection
- Over Temperature Protection
- SOT23-5, SOT89-3 Packages

### General Description

The HT78XX series are a group of low-dropout ( LDO ) voltage regulators offering the benefits of wide input voltage range from 1.2V to 5.5V, low dropout voltage, low power consumption, and miniaturized packaging. Quiescent current of only 2μA makes these devices ideal for powering the battery-powered, always-on systems that require very little idle-state power dissipation to a longer service life. There is an option of

### Applications

- Portable, Battery Powered Equipment
- Low Power Microcontrollers
- Laptop, Palmtops and PDAs
- Wireless Communication Equipment
- Audio/Video Equipment
- Car Navigation Systems

shutdown mode by selecting the parts with the EN pin and pulling it low. The shutdown current in this mode goes down to only 10nA ( typical ).

The HT78XX series of linear regulators are stable with the ceramic output capacitor over its wide input range from 1.2V to 5.5V and the entire range of output load current ( 0mA to 500mA ).

### Ordering Information

**HT7833**

Output voltage: 12=1.2V  
15=1.5V  
18=1.8V  
30=3.0V  
33=3.3V  
XX=X.XV

**PIN CONFIGURATION**

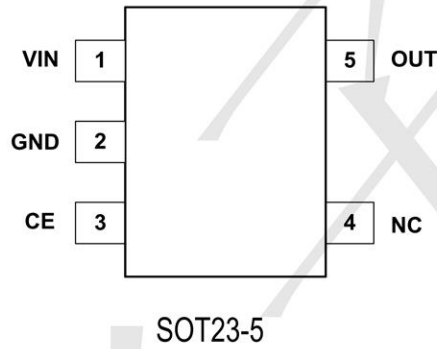
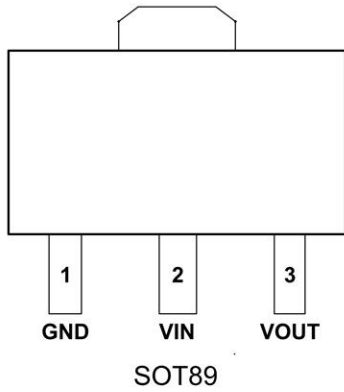

**Typical Application Circuit**

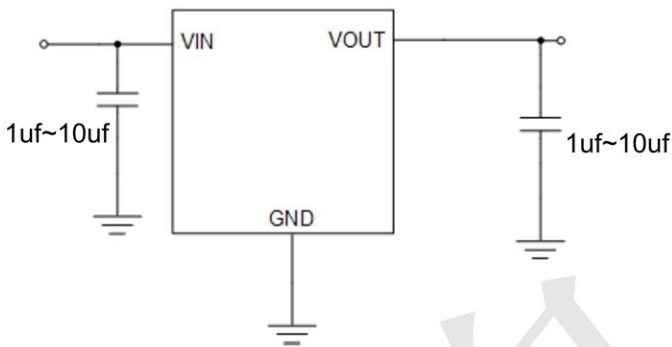

Figure 1: Application circuit of Fixed  $V_{OUT}$  LDO

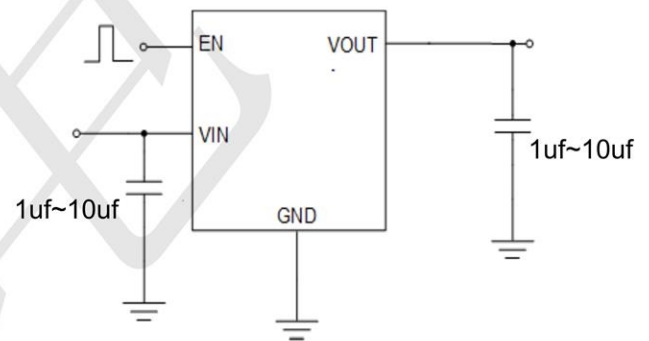

Figure 2: Application circuit of Fixed  $V_{OUT}$  LDO with enable function

**ABSOLUTE MAXIMUM RATINGS**

Parameter		Value	Unit
Supply Voltage		-0.3~+6.5	V
Power Dissipation	SOT-23-5	400	mW
	SOT-89	600	mW
Thermal Resistance, Junction-to-Ambient	SOT-23-5	380	°C/W
	SOT-89	180	°C/W
Operating Junction Temperature		-40 ~ +125	°C
Storage Temperature Range		-65 ~ +150	°C
Lead Temperature (Soldering, 10 sec)		300	°C

**Electrical Characteristics** ( $T_A=25\text{ C}$  unless otherwise noted)

( $V_{IN}=5V$ ,  $V_{EN}=5V$   $T_A=25^\circ\text{C}$  unless otherwise specified)

Parameter	Symbol	Test Conditions	Min	Typ	Max	Unit	
Supply Voltage	$V_{IN}$		1.2	--	5.5	V	
DC Output Voltage Accuracy		$I_{LOAD}=0.1\text{mA}$	-2		2	%	
Dropout Voltage ( $I_{LOAD}=600\text{mA}$ ) (Note 3)	$V_{DROP\_3V}$	$V_{OUT} \geq 3V$		0.32		V	
	$V_{DROP\_2.8V}$	$V_{OUT} = 2.8V$		0.36			
	$V_{DROP\_2.5V}$	$V_{OUT} = 2.5V$		0.36			
	$V_{DROP\_1.8V}$	$V_{OUT} = 1.8V$		0.57			
	$V_{DROP\_1.5V}$	$V_{OUT} = 1.5V$		0.71			
	V	$V = 1.2V$		0.8			
Ground Current	$I_Q$	$I_{LOAD}=0\text{mA}$		2		$\mu\text{A}$	
Shutdown Ground Current	$I_{SD}$	$V_{EN}=0V$ ,		0.01	0.5	$\mu\text{A}$	
$V_{OUT}$ Shutdown Leakage Current	$I_{LEAK}$	$V_{OUT}=0V$		0.01	0.5		
Enable Threshold Voltage	$V_{IH}$	EN Rising			2	V	
	$V_{IL}$	EN Falling	0.6				
EN Input Current	$I_{EN}$	$V_{EN}=5V$		10	100	nA	
Line Regulation	$\Delta_{LINE}$	$I_{LOAD}=30\text{mA}$ , $1.5V \leq V_{IN} \leq 5.5V$ or $(V_{OUT} + 0.2V) \leq V_{IN} \leq 5.5V$		0.2		%	
Load Regulation	$\Delta_{LOAD}$	$10\text{mA} \leq I_{LOAD} \leq 0.3A$		0.2		%	
Output Current Limit	$I_{LIM}$	$V_{OUT}=0$	500	800		mA	
Power Supply Rejection Ratio ( $I_{LOAD}=5\text{mA}$ )	PSRR	$V_{OUT}=1.2V$ , $V_{IN}=2V$	f = 100Hz	--	80	--	dB
			f = 1kHz	--	75	--	
Output Voltage Noise (BW = 10Hz to 100kHz, $C_{OUT}=1\mu\text{F}$ .)		$V_{IN}=3.5V$ $I_{LOAD}=0.1A$	$V_{OUT}=0.9V$	--	40	--	$\mu\text{V}_{RMS}$
			$V_{OUT}=2.8V$	--	50	--	
Thermal Shutdown Temperature	$T_{SD}$	$I_{LOAD}=10\text{mA}$		--	155	--	$^\circ\text{C}$
Thermal Shutdown Hysteresis	$\Delta T_{SD}$			--	15	--	$^\circ\text{C}$
Discharge Resistance		$EN=0V$ , $V_{OUT}=0.1V$	--	100	--	$\Omega$	

**Note 1.** Stresses beyond those listed “Absolute Maximum Ratings” may cause permanent damage to the device. These are stress ratings only, and functional operation of the device at these or any other conditions beyond those indicated in the operational sections of the specifications is not implied. Exposure to absolute maximum rating conditions may affect device reliability.

**Note 2.**  $\theta_{JA}$  is measured at  $T_A = 25^\circ\text{C}$  on a TECH PUBLICboard.

**Note 3.**  $V_{DROP} = V_{IN} - V_{OUT}$  when the  $V_{OUT}$  is 98% of its target value.



**Typical Characteristics**

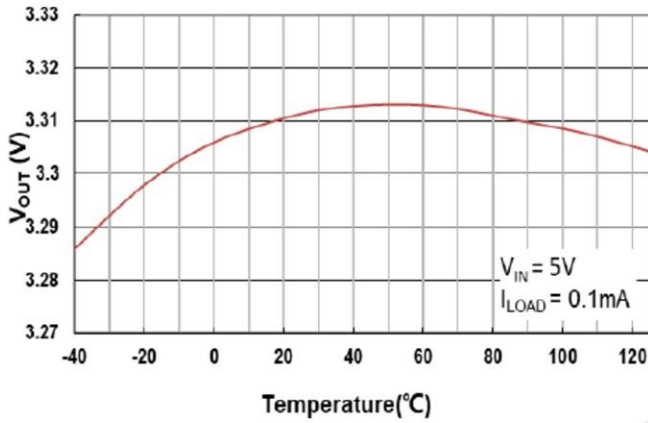

Fig. 5 Output Voltage vs. Temperature

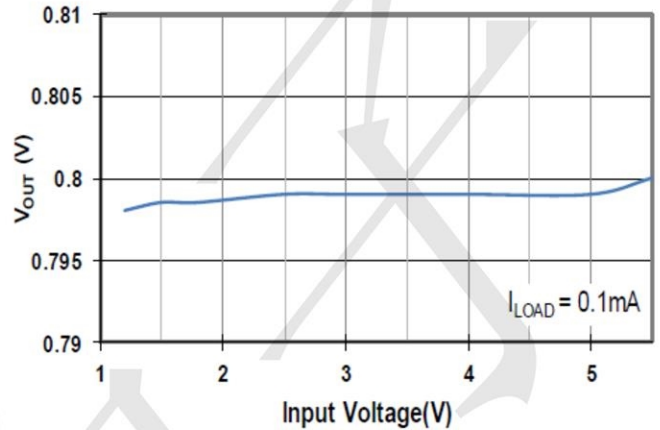

Fig. 6 Output Voltage vs. Input Voltage

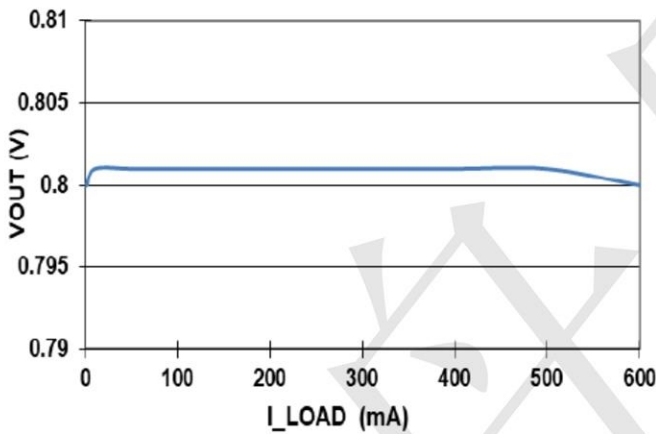

Fig. 7 Output Voltage vs. Load Current

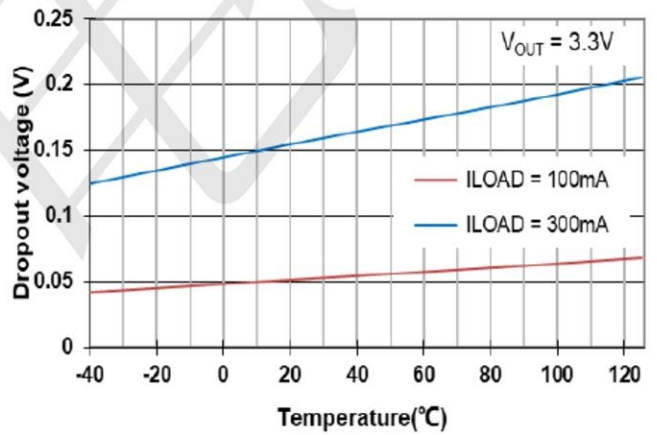

Fig. 8 Dropout Voltage vs. Temperature

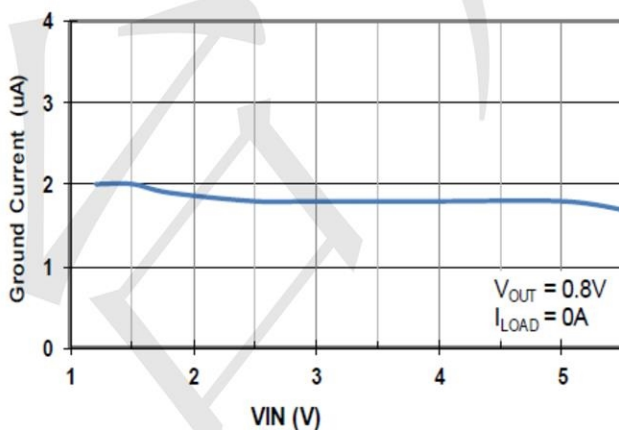

Fig. 9 Ground Current vs. Input Voltage

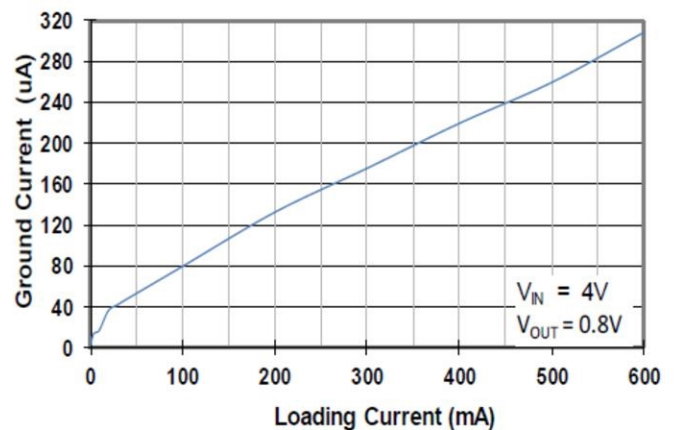
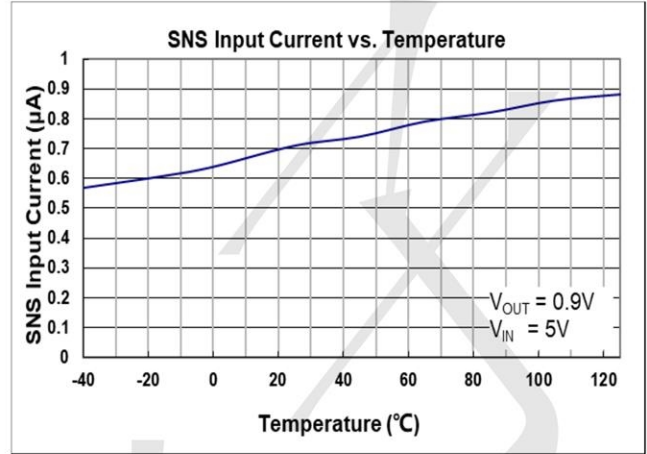
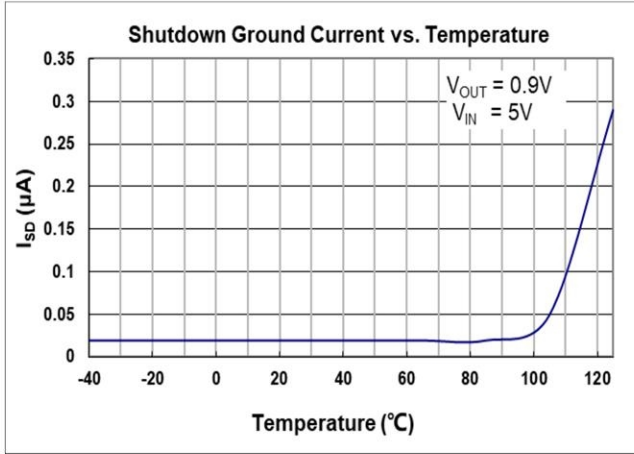
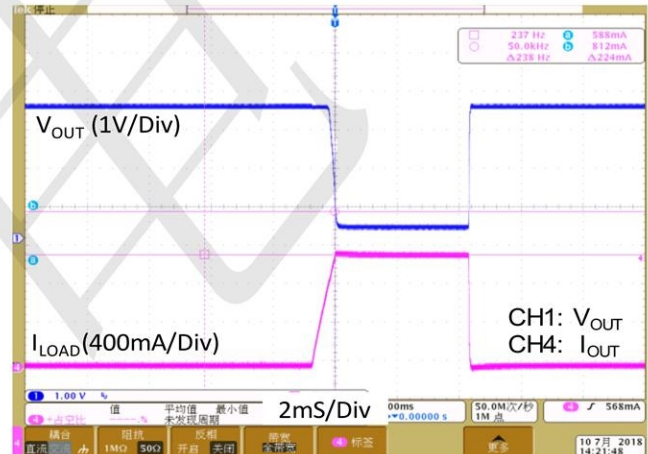
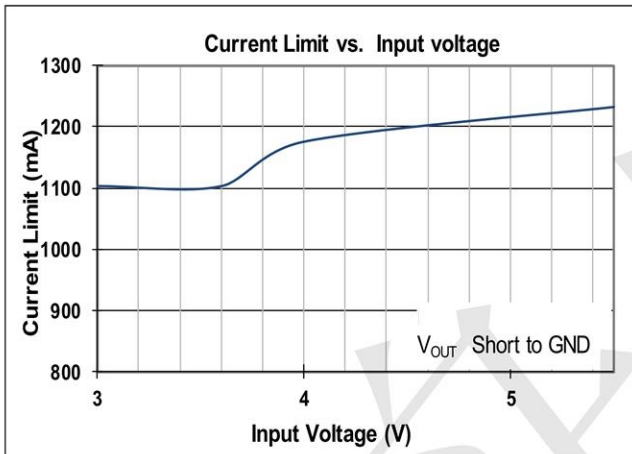

Fig. 10 Ground Current vs. Loading Current



**Current Limit Response**



**Load Transient Response I**

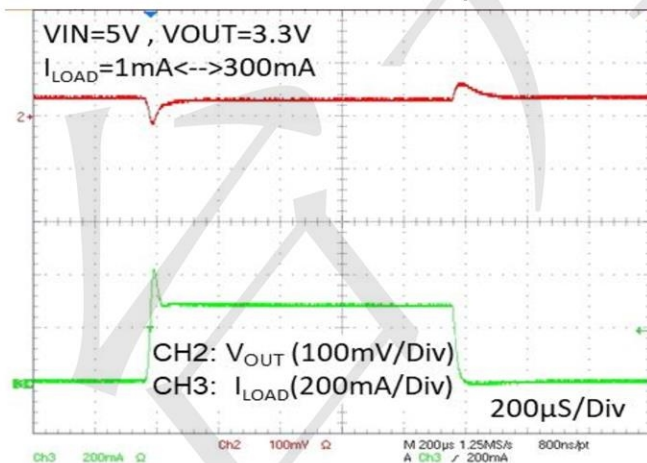

**Load Transient Response II**

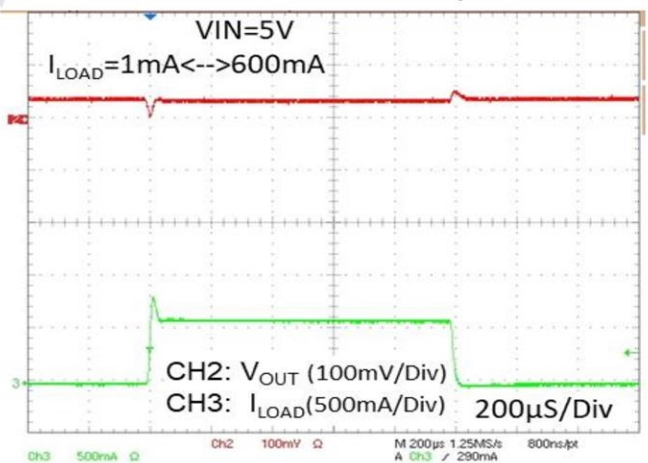

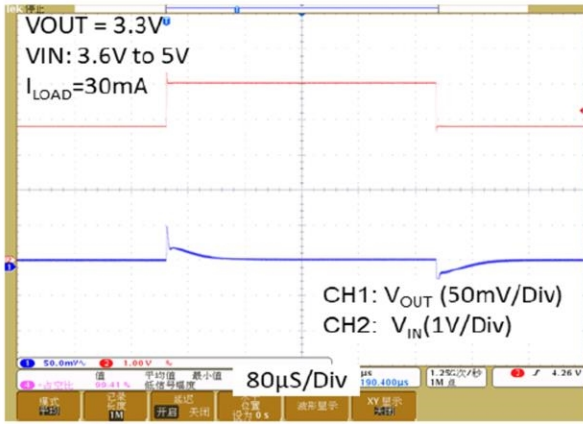

Fig. 17 Line Transient Response

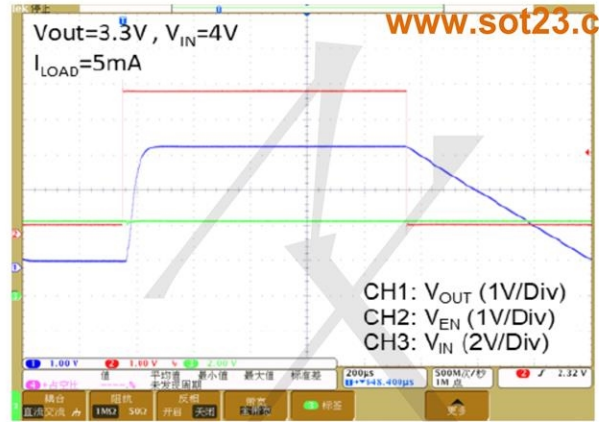

Fig. 18 V<sub>OUT</sub> Turn On/Off by EN

**BLOCK DIAGRAM**

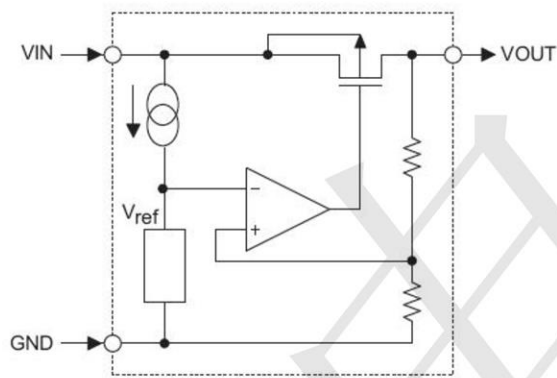
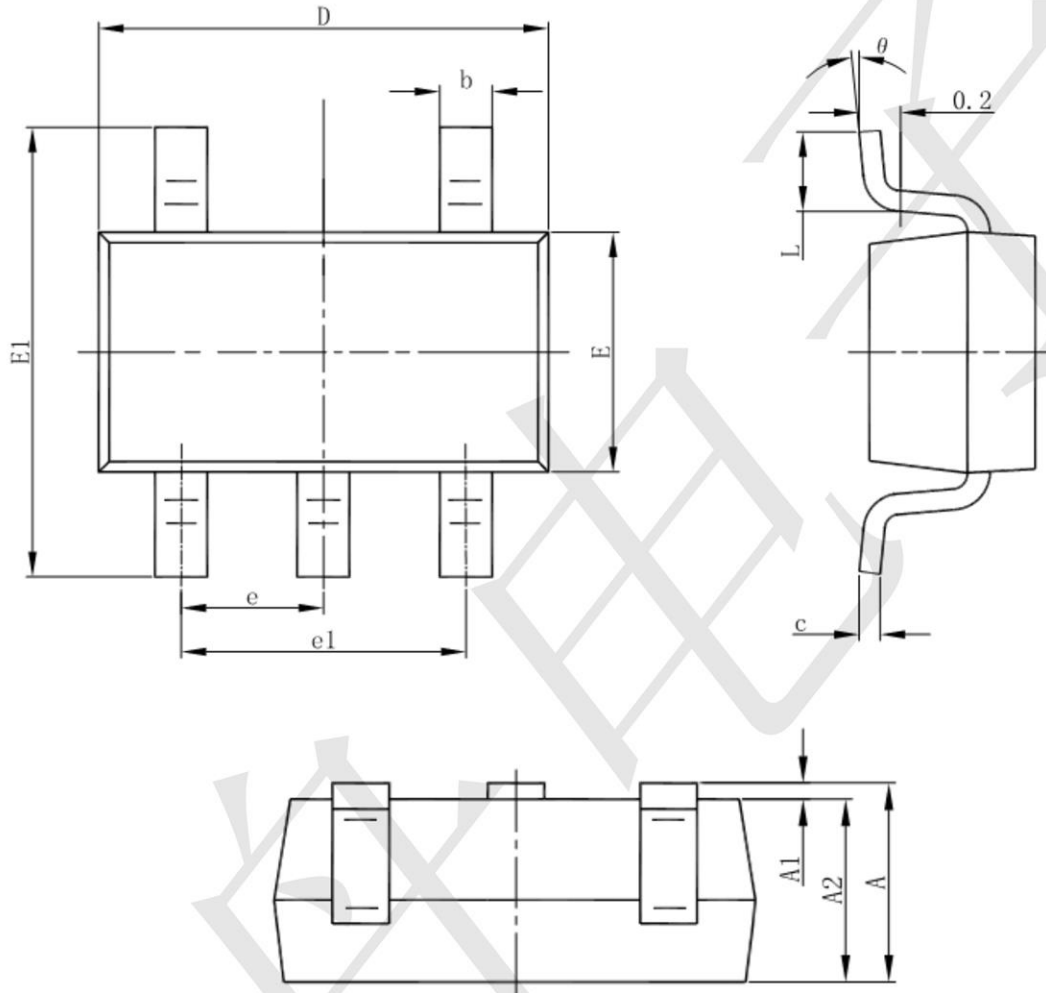

Figure 2.HT75XX Block Diagram



**Package informantion**

SOT23-5



Symbol	Dimensions In Millimeters		Dimensions In Inches	
	Min	Max	Min	Max
A	1.050	1.250	0.041	0.049
A1	0.000	0.100	0.000	0.004
A2	1.050	1.150	0.041	0.045
b	0.300	0.500	0.012	0.020
c	0.100	0.200	0.004	0.008
D	2.820	3.020	0.111	0.119
E	1.500	1.700	0.059	0.067
E1	2.650	2.950	0.104	0.116
e	0.950(BSC)		0.037(BSC)	
e1	1.800	2.000	0.071	0.079
L	0.300	0.600	0.012	0.024
theta	0°	8°	0°	8°



**Package information**  
SOT89-3

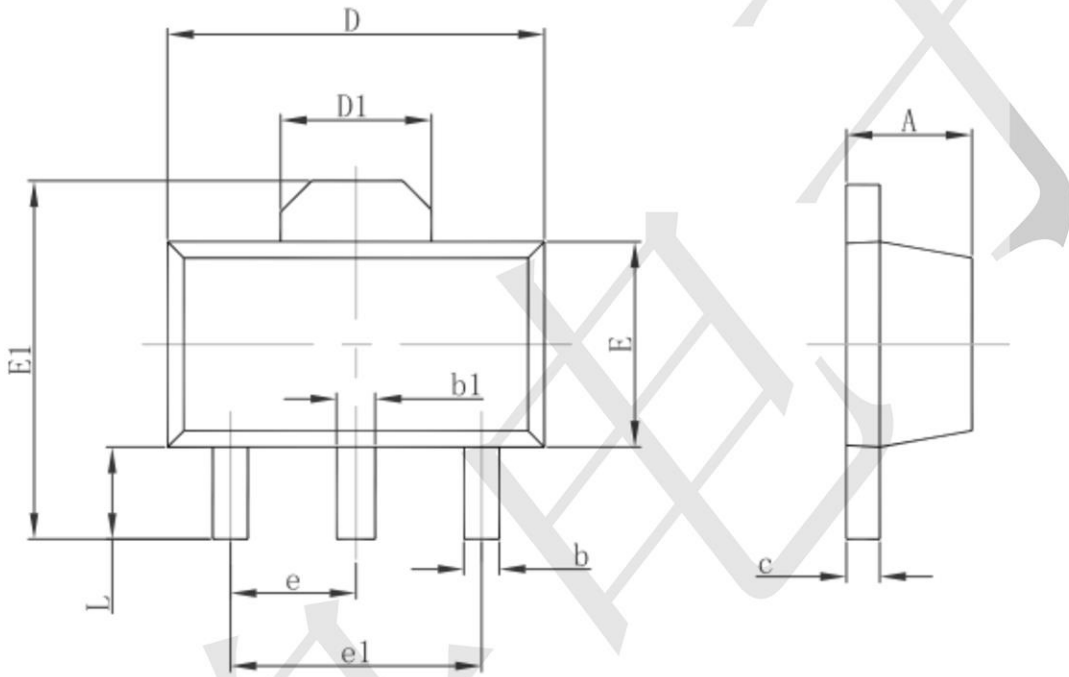

Symbol	Dimensions In Millimeters		Dimensions In Inches	
	Min.	Max.	Min.	Max.
A	1.400	1.600	0.055	0.063
b	0.320	0.520	0.013	0.020
b1	0.400	0.580	0.016	0.023
c	0.350	0.440	0.014	0.017
D	4.400	4.600	0.173	0.181
D1	1.550 REF.		0.061 REF.	
E	2.300	2.600	0.091	0.102
E1	3.940	4.250	0.155	0.167
e	1.500 TYP.		0.060 TYP.	
e1	3.000 TYP.		0.118 TYP.	
L	0.900	1.200	0.035	0.047