

Vector Network Analyzers

TTR500 Series Datasheet



Legendary support and quality meets ease-of-use and affordability. The Tektronix TTR500 series 2-port, 2-path VNA is our latest breakthrough - an unmatched combination of measurement performance and convenience. Get the power to make everyday measurements with the accuracy and confidence you expect from Tektronix, all without breaking your budget.

Key performance specifications

- 100 kHz to 6 GHz frequency range
- > 122 dB dynamic range
- -50 to +7 dBm output power
- < 0.008 dB RMS trace noise

Key features

- Full 2-port 2-path S-parameter measurement (S_{11} , S_{21} , S_{12} , S_{22}) in a variety of formats.
- Complete vector network analysis capability with Tektronix VectorVu-PC™ software.
- Built-in bias tee accessible on both ports to bias active devices.
- Application programming interface (API) for Microsoft Windows environment and LabView driver.
- Robust SCPI command interface (compatible with current VNA models) to optimize code migration.
- Touchstone file support (import/export) for use with Electronic Design Automation (EDA) simulation tools.
- Offline simulation mode for analysis of S-parameter files when disconnected from the instrument.
- Industry-leading three year warranty.
- Time domain with gating.
- Automatic calibration support.

Applications

- Antenna matching and tuning
- RF component design and validation
- Education

Benchtop performance at a fraction of the cost

The TTR500 offers industry-leading price and performance. With more than 122 dB dynamic range and less than 0.008 dB RMS trace noise, the TTR500 has performance similar to expensive, conventional benchtop VNAs.

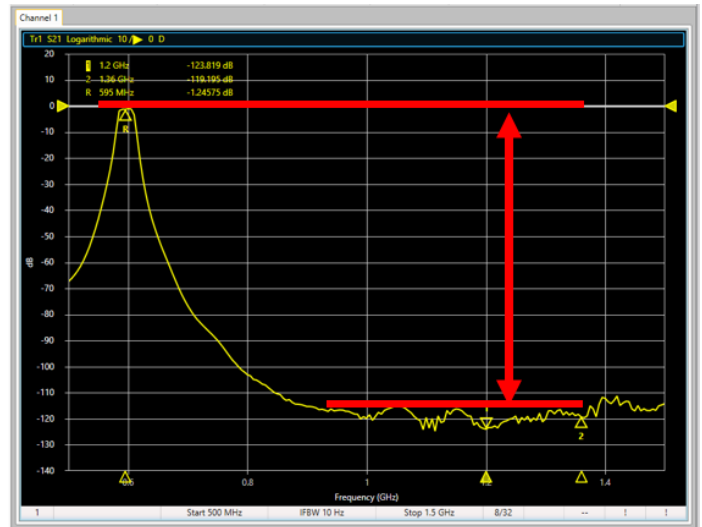

Compact and transportable: Take test where you need it

Gone are the days when you had to roll a cart with a heavy, shared VNA. Weighing under 3.5 lbs (1.59 kg), the TTR500 has a form factor small enough to fit in a briefcase. With a price tag to match, you can put a VNA on every engineering bench to improve efficiency and uptime. In a classroom, students can get hands-on experience with industry standard test instrumentation.



Performance, size, reliability, affordability - choose four

The TTR500A series VNA includes an impressive array of technological and patented advances that allowed us to bend many of the traditional trade-offs between RF performance, size, reliability, and cost.

Performance: Inside the VNA is a tightly integrated, single-board design. At its core lies a proprietary ASIC that implements all of the transmitting and receiving functions. Along with decades of experience in RF front-end and shielding design, this integration allowed us to implement advanced DSP and patented error correction techniques that dramatically improve measurement accuracy and dynamic range.

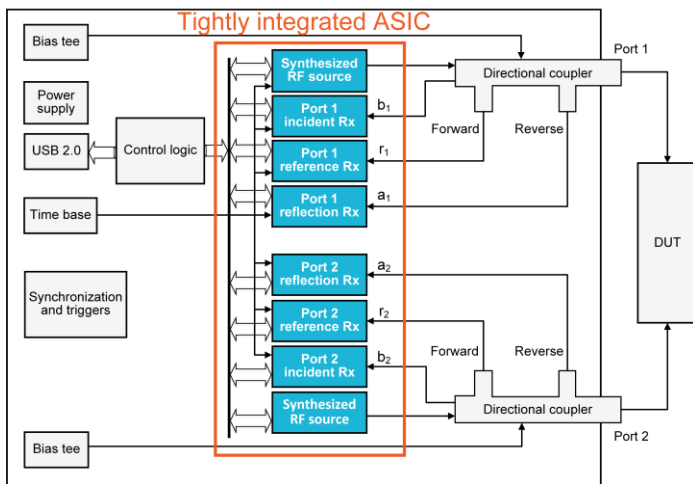

Convenience: Traditional benchtop VNAs have a computer inside that typically becomes obsolete by the time the product hits the market. Our architecture enables significant improvements in size, cost, and reliability by communicating over USB to your PC, while adding additional benefits and convenience. For example, run VectorVu-PC with other applications, share data seamlessly, and save individual application setups on your PC when multiple users share the TTR500.

Size: A compact single-board design without heavy input and display components allows the TTR500 to pack a lot of powerful functionality in a tablet-sized frame. Store it in a drawer, pack it in your briefcase, or carry it on a plane. Take quality test and measurement technology wherever you need it.

Reliability: In addition to reduced part count, integration on a singleboard consumes less energy than traditional benchtop VNAs. The board generates less heat, resulting in lower component stresses and higher reliability. A fanless design provides a quieter operation. We back all of this with a three year warranty.

Affordability: With fewer parts and an integrated design, we created a handheld VNA that delivers traditional benchtop performance and convenience at an unrivaled price. Why settle for less?

Integrated bias tee for active devices

Use the built-in bias tee (standard in both models) to provide a DC bias to active devices without the expense and complication of external circuitry. Power the bias tee directly through BNC connectors on the rear panel.

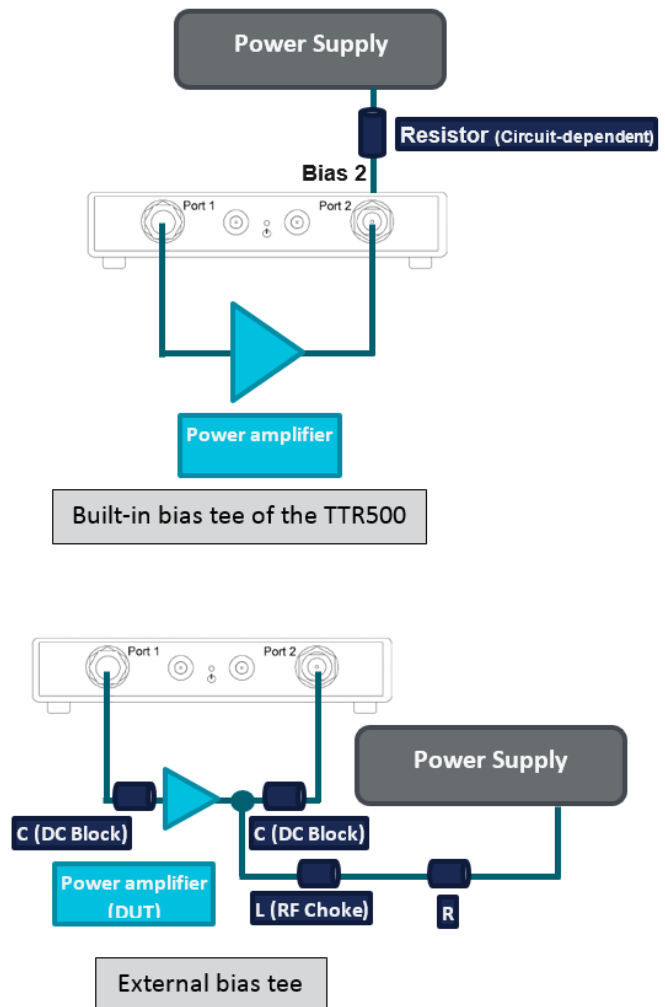

Complete line of affordable accessories

To simplify shopping for the complete VNA solution, Tektronix offers a range of accessories for high-accuracy measurements. Select from calibration kits (electronic and mechanical), phase-stable cables, adapters, attenuators, rackmount, rugged carry case, and a training kit. See Ordering Information for a full list of available accessories.



Full 2-port 2-path S-parameter measurements



*PC not included.

An independent RF source and three RF receivers for each port of the TTR500 enable you to take high-accuracy magnitude and phase measurements with a 1-port or 2-port device under test (DUT). Use the TTR500 to perform complete S_{11} , S_{12} , S_{21} , and S_{22} measurements of the DUT and display data in a variety of formats (see measurement functionality table).

VectorVu-PC measurement functionality

| Sweep types | Measured parameters |
|--|---|
| Frequency (linear or log) Segmented Power | S_{11} , S_{12} , S_{21} , S_{22} Absolute receiver level |
| Data display formats | Channel/trace functions |
| Logarithmic magnitude Linear magnitude Phase Expanded phase Group delay Smith chart Polar SWR Real/Imaginary | Up to 16 channels Up to 16 traces/channel Up to 9 markers/trace + reference marker Memory math Averaging Smoothing Save/load state, calibration, and trace data |
| Calibration | Trigger |
| Response (Reflection/Transmission) Enhanced response Full 1-port SOL Full 2-port SOLT User-defined calibration kit Electronic calibration | Manual Internal External SCPI command |
| Sweep modes | Analysis tools |
| Fast Normal | Limit line test Ripple limit test Bandwidth test Time domain with gating |

Rapid measurement and analysis with VectorVu-PC

VectorVu-PC (available as free download) features an industry-standard interface that minimizes the learning curve so you have more time to test your design. The software delivers a traditional look and feel to control and calibrate the instrument, while providing touchscreen compatibility for Windows PC, laptop, or tablet. For automated test systems, we include a SCPI programming interface that is compatible with common legacy VNAs. A LabView driver is also available for analysis and control. See the TTR500 programmer manual for more information.

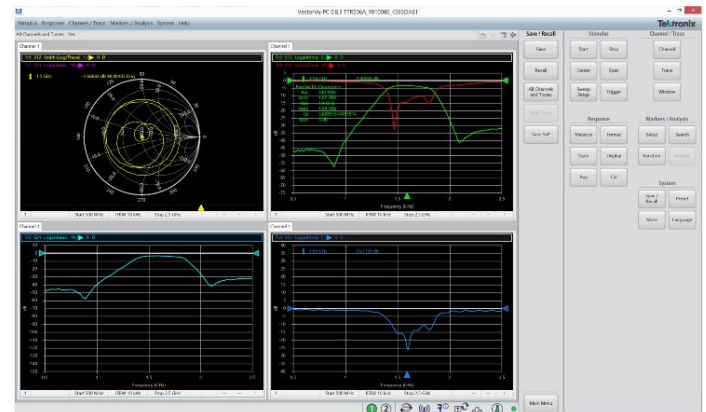

Offline simulation mode for convenient data analysis

VectorVu-PC features a simulation mode to analyze S-parameter data when disconnected from the TTR500. Capture measurements at the test site and analyze the data anywhere. Share it with your team or class when access to the TTR500 is limited.

Compatibility with EDA simulation tools

VectorVu-PC supports the Touchstone (S1P, S2P) file format to import and export S-parameter data in the simulation mode. You can also share data in this format with common EDA simulation tools.

Accelerate test with electronic calibration support

The Tektronix TCAL™ 500 makes calibration of Tektronix vector network analyzers fast, easy, and accurate. Cut calibration time down to roughly half the time compared to using traditional mechanical calibration kits. What normally takes 8 connections and 8 button-presses with a traditional cal kit, takes only 2 connections and 1 button press with the TCAL™ 500. The TCAL™ 500 is ideal for integration on production lines or R&D labs where speed, repeatability, and accuracy are critical.

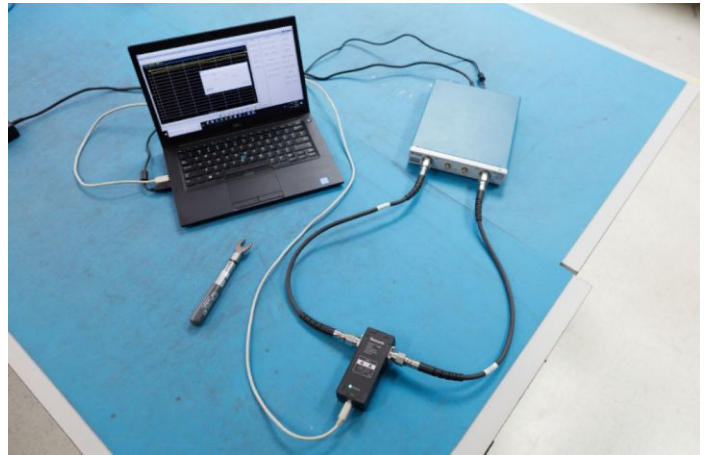

Time domain measurements with gating

Time domain (TDR) measurements are supported as a field-upgradeable software license option to allow for S-parameter data to be analyzed in the time-domain. This is useful for detecting and locating faults in cables and transmission lines, analyzing impedance variations in connectors and traces, gating out the effects of fixtures and in-line elements, or simplifying filter tuning. Various supported modeled stimulus types include bandpass, lowpass impulse, and lowpass step.

Tektronix: A name you can trust

For over 70 years, Tektronix has delivered industry-leading solutions to the people who drive technological progress. We maintain unrivaled standards of quality, reliability, service, and support with every product, like free access to our Technical Support Centers around the world.

Specifications

All specifications are warranted performance characteristics with guaranteed tolerance limits, unless noted otherwise. All specifications are valid between 18 °C and 28 °C ambient temperature and apply to all models unless noted otherwise.

Nominal refers to the features or characteristics of the design.

Typical indicates that 80% of units will meet the published typical performance with 80% confidence, unless otherwise noted. Typical performance is not warranted.

Typical-Mean indicates the mean performance measured on a sample of units immediately after performing an alignment. Typical-Mean performance is not warranted.

General

Frequency range

| | |
|----------------|--------------------|
| TTR503A | 100 kHz to 3.0 GHz |
| TTR506A | 100 kHz to 6.0 GHz |

Ports 2-ports, Type-N female connectors

Measurements Two-port, two-path S-parameters (S_{11} , S_{12} , S_{21} , S_{22}) and related measurements.

Connectivity USB 2.0

Software VectorVu-PC™ (requires Windows® 7/8/10, 64-bit)

Corrected system performance with calibration kit

Tektronix TCAL500 35mm SMA-type electrical calibration kits

(TCAL500-35F, TCAL500-35MF, TCAL500-35M)

| Frequency | Directivity (dB) | Source match (dB) | Load match (dB) | Reflection tracking (±dB) | Transmission tracking (±dB) |
|--|------------------|-------------------|-----------------|---------------------------|-----------------------------|
| 300 kHz to < 500 kHz | -47.5 | -36.6 | -47 | 0.062 | 0.066 |
| 500 kHz to < 2MHz | -50.7 | -39.6 | -47 | 0.062 | 0.042 |
| 2 MHz to < 10 MHz | -50.7 | -39.6 | -47 | 0.062 | 0.042 |
| 10 MHz to < 200 MHz | -50.7 | -39.6 | -47 | 0.062 | 0.042 |
| 200 MHz to < 1.5 GHz | -46.6 | -34.8 | -37.1 | 0.08 | 0.073 |
| 1.5 GHz < 3 GHz | -46.6 | -34.8 | -37.1 | 0.08 | 0.073 |
| 3 GHz to 6 GHz | -39.7 | -25.3 | -36 | 0.166 | 0.156 |
| 18 °C to 28 °C, within 1 °C of calibration temperature and at the same ambient humidity conditions in which calibration was performed. | | | | | |

Tektronix TCAL500 N-type electrical calibration kits

(TCAL500-NF, TCAL500-NMF, TCAL500-NM)

| Frequency | Directivity (dB) | Source match (dB) | Load match (dB) | Reflection tracking (±dB) | Transmission tracking (±dB) |
|--|------------------|-------------------|-----------------|---------------------------|-----------------------------|
| 300 kHz to < 500 kHz | -45.8 | -33.8 | -47 | 0.062 | 0.066 |
| 500 kHz to < 2MHz | -45.8 | -36.3 | -47 | 0.062 | 0.042 |
| 2 MHz to < 10 MHz | -45.8 | -39.1 | -47 | 0.062 | 0.042 |
| 10 MHz to < 200 MHz | -45.8 | -39.1 | -47 | 0.062 | 0.042 |
| 200 MHz to < 1.5 GHz | -41.5 | -34.8 | -37.1 | 0.08 | 0.073 |
| 1.5 GHz < 3 GHz | -41.5 | -34.8 | -37.1 | 0.08 | 0.073 |
| 3 GHz to 6 GHz | -35.7 | -25.3 | -35 | 0.166 | 0.156 |
| 18 °C to 28 °C, within 1 °C of calibration temperature and at the same ambient humidity conditions in which calibration was performed. | | | | | |

Spinner Type-N mechanical calibration kit BN533861

User Correction ON.

Two 60 cm Tektronix cables 012-1765-00 or 012-1768-00

| Frequency | Directivity (dB) | Source match (dB) | Load match: Insertable devices (dB) | Load match with M-M or F-F thru (dB) | Reflection tracking (dB) | Transmission tracking: Insertable devices (dB) |
|--|------------------|-------------------|-------------------------------------|--------------------------------------|--------------------------|--|
| 300 kHz to < 1 MHz | -38 | -34 | -37 | -35 | 0.08 | 0.05 |
| 1 MHz to < 10 MHz | -37 | -34 | -37 | -35 | 0.08 | 0.02 |
| 10 MHz to < 100 MHz | -37 | -34 | -37 | -35 | 0.08 | 0.01 |
| 100 MHz to < 1 GHz | -36 | -34 | -37 | -35 | 0.08 | 0.01 |
| 1 GHz to < 3 GHz | -36 | -34 | -37 | -35 | 0.08 | 0.02 |
| 3 GHz to 6 GHz | -36 | -34 | -36 | -35 | 0.09 | 0.02 |
| 18 °C to 28 °C, within 1 °C of calibration temperature and at the same ambient humidity conditions in which calibration was performed. | | | | | | |

Corrected system performance with calibration kitSpinner 3.5 mm mechanical
calibration kit BN533854

User Correction ON.

Two 60 cm Tektronix cables 012-1769-00 or 012-1772-00

| Frequency | Directivity (dB) | Source match (dB) | Load match: Insertable devices (dB) | Load match with M-M or F-F thru (dB) | Reflection tracking (dB) | Transmission tracking: Insertable devices (dB) |
|--|------------------|-------------------|-------------------------------------|--------------------------------------|--------------------------|--|
| 300 kHz to < 1 MHz | -36 | -33 | -37 | -35.5 | 0.1 | 0.06 |
| 1 MHz to < 10 MHz | -35 | -33 | -37 | -35.5 | 0.1 | 0.02 |
| 10 MHz to < 100 MHz | -35 | -33 | -37 | -35.5 | 0.1 | 0.01 |
| 100 MHz to < 1 GHz | -35 | -33 | -35 | -35.5 | 0.1 | 0.01 |
| 1 GHz to < 4 GHz | -35 | -33 | -35 | -35.5 | 0.1 | 0.02 |
| 4 GHz to 6 GHz | -28 | -28 | -29 | -29 | 0.22 | 0.03 |
| 18 °C to 28 °C, within 1 °C of calibration temperature and at the same ambient humidity conditions in which calibration was performed. | | | | | | |

Spinner Type-N calibration kit
BN533844

User Correction ON.

Two 60 cm Tektronix cables 012-1765-00

| Frequency | Directivity (dB) | Source match (dB) | Load match: Insertable devices (dB) | Load match with M-M or F-F thru (dB) | Reflection tracking (dB) | Transmission tracking: (dB) |
|--|------------------|-------------------|-------------------------------------|--------------------------------------|--------------------------|-----------------------------|
| 300 kHz to < 1 MHz | -32 | -31 | -32 | -31 | 0.15 | 0.07 |
| 1 MHz to < 10 MHz | -32 | -31 | -32 | -31 | 0.15 | 0.03 |
| 10 MHz to < 100 MHz | -31 | -31 | -32 | -31 | 0.15 | 0.01 |
| 100 MHz to < 1 GHz | -31 | -31 | -32 | -31 | 0.15 | 0.01 |
| 1 GHz to < 4 GHz | -31 | -31 | -32 | -31 | 0.15 | 0.02 |
| 4 GHz to 6 GHz | -25 | -25 | -26 | -26 | 0.3 | 0.04 |
| 18 °C to 28 °C, within 1 °C of calibration temperature and at the same ambient humidity conditions in which calibration was performed. | | | | | | |

Uncorrected system performance

User correction OFF. Factory correction ON.

| Frequency | Directivity (dB) | Source match (dB) | Load match (dB) | Reflection tracking (dB) | Transmission tracking (dB) |
|----------------------|------------------|-------------------|-----------------|--------------------------|----------------------------|
| 300 kHz to < 500 kHz | -25 | -25 | -4.5 | ±1 | ±1 |
| 500 kHz to < 2 MHz | -25 | -25 | -4.5 | ±1 | ±1 |
| 2 MHz to < 10 MHz | -25 | -25 | -11 | ±1 | ±1 |
| 10 MHz to < 200 MHz | -25 | -25 | -11 | ±1 | ±1 |
| 200 MHz to < 1.5 GHz | -25 | -25 | -10 | ±1 | ±1 |
| 1.5 GHz to < 4.5 GHz | -25 | -25 | -8 | ±1 | ±1 |
| 4.5 GHz to < 5 GHz | -25 | -25 | -7 | ±1 | ±1 |
| 5 GHz to 6 GHz | -25 | -25 | -7 | ±1 | ±1 |

Frequency

Range

| | |
|---------|--------------------|
| TTR503A | 100 kHz to 3.0 GHz |
| TTR506A | 100 kHz to 6.0 GHz |

Resolution 1 Hz

Accuracy ± 7.0 ppm over 1 year calibration interval, 18 °C to 28 °C

Internal reference

| | |
|------------------|-------------|
| Frequency | 10 MHz |
| Initial accuracy | ± 10 Hz |

External reference input 10 MHz ± 50 Hz

Test port output

| | 300 kHz to < 1 MHz | 1 MHz to < 2 MHz | 2 MHz to < 3 GHz | 3 GHz to < 4.5 GHz (TTR506A) | 4.5 GHz to 6 GHz (TTR506A) |
|--|---------------------------------------|---------------------|---------------------|------------------------------|----------------------------|
| Settable level | -50 dBm to + 10 dBm | -50 dBm to + 10 dBm | -50 dBm to + 10 dBm | -50 dBm to + 10 dBm | -50 dBm to +10 dBm |
| Harmonics at levels ≤ 0 dBm (typical) | -25 dB | -30 dBc | -30 dBc | -30 dBc | -30 dBc |
| Level accuracy -25 dBm to 3 dB below max specified output power | ± 2.5 dB ± 1.7 dB, typical | | | | |
| Max output power (typical) | 2 dBm | 2 dBm | 9 dBm | 8 dBm | 7 dBm |

Test port input

Dynamic range

| Description | | 300 kHz to < 1 MHz | 1 MHz to < 2 MHz | 2 MHz to < 200 MHz | 200 MHz to < 3 GHz | 3 GHz to < 4.5 GHz (TTR506A only) | 4.5 GHz to 6 GHz (TTR506A only) |
|---------------|---------------|-------------------------------------|---------------------------------------|---------------------------------------|---------------------------------------|---------------------------------------|---------------------------------------|
| Dynamic range | Typical | 112 dB | 117 dB | 124 dB | 125 dB | 123 dB | 122 dB |
| | Specification | - | - | - | 124 dB | 123 dB | 122 dB |
| Noise floor | | -110 dBm/Hz (< -115 dBm/Hz typical) | < -120 dBm/Hz (< -125 dBm/Hz typical) | < -120 dBm/Hz (< -125 dBm/Hz typical) | < -125 dBm/Hz (< -130 dBm/Hz typical) | < -125 dBm/Hz (< -130 dBm/Hz typical) | < -125 dBm/Hz (< -130 dBm/Hz typical) |

Crosstalk with load

| Description | 300 kHz to < 1 MHz | 1 MHz to < 10 MHz | 10 MHz to < 200 MHz | 200 MHz to < 1 GHz | 1 GHz to < 2 GHz | 2 GHz to 6 GHz (TTR506A only above 3 GHz) |
|--|--------------------|-------------------|---------------------|--------------------|------------------|---|
| Uncorrected crosstalk with load | -85 dB | -110 dB | -105 dB | -120 dB | -115 dB | -120 dB |
| Corrected crosstalk with load ¹ | -90 dB | -118 dB | -115 dB | -125 dB | -125 dB | -120 dB |

¹ After full 2-port SOLT calibration with isolation using a Spinner BN533861 Type-N 50 Ω load.

Dynamic accuracy and compression

Dynamic accuracy

| Received level range | 105 MHz | 2 GHz |
|----------------------|---------|---------|
| > +5 to +10 dBm | 0.65 dB | 0.4 dB |
| > 0 to +5 dBm | 0.35 dB | 0.2 dB |
| > -20 to 0 dBm | 0.2 dB | 0.15 dB |
| > -34 to -20 dBm | 0.25 dB | 0.2 dB |
| > -50 to -34 dBm | 0.35 dB | 0.3 dB |
| > -60 to -50 dBm | 0.55 dB | 0.45 dB |

Dynamic accuracy, typical-mean

| Received level range | 10 MHz | 105 MHz | 350 MHz | 783.5 MHz | 1.083 GHz | 2 GHz | 3 GHz | 4 GHz | 5.25 GHz | 6 GHz |
|----------------------|---------|---------|---------|-----------|-----------|---------|---------|---------|----------|---------|
| > +5 to +10 dBm | 0.4 dB | 0.3 dB | 0.3 dB | 0.3 dB | 0.25 dB | 0.2 dB | 0.2 dB | 0.15 dB | 0.15 dB | 0.15 dB |
| > 0 to +5 dBm | 0.25 dB | 0.25 dB | 0.1 dB | 0.1 dB | 0.1 dB | 0.05 dB | 0.05 dB | 0.05 dB | 0.05 dB | 0.05 dB |
| > -30 to 0 dBm | 0.15 dB | 0.1 dB | 0.1 dB | 0.1 dB | 0.1 dB | 0.1 dB | 0.1 dB | 0.1 dB | 0.1 dB | 0.1 dB |
| -50 to -30 dBm | 0.2 dB | 0.15 dB | 0.15 dB | 0.15 dB | 0.15 dB | 0.15 dB | 0.15 dB | 0.15 dB | 0.15 dB | 0.15 dB |

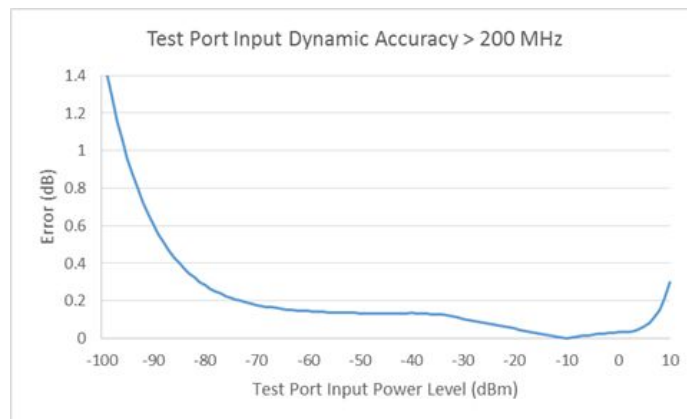
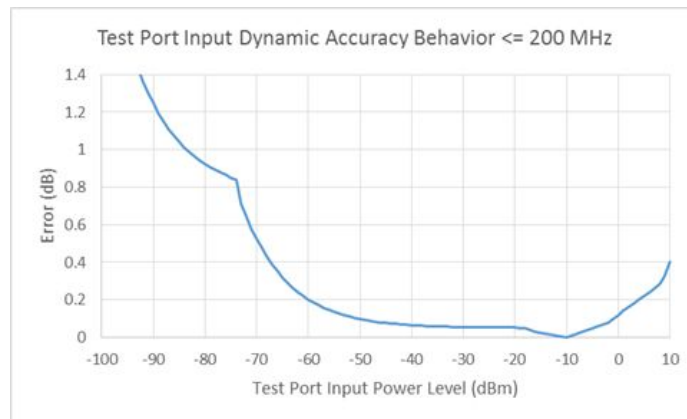

Test port compression at maximum input level

Compression at +10 dBm input level (typical-mean) is > +5 to +10 dBm

| Frequency | 10 MHz | 105 MHz | 350 MHz | 783.5 MHz | 1.083 MHz | 2 GHz | 3 GHz | 4 GHz | 5.25 GHz | 6 GHz |
|-------------|--------|---------|---------|-----------|-----------|--------|--------|--------|----------|--------|
| Compression | 0.4 dB | 0.4 dB | 0.3 dB | 0.25 dB | 0.25 dB | 0.2 dB | 0.2 dB | 0.2 dB | 0.2 dB | 0.2 dB |

Dynamic accuracy and compression

| | | | |
|------------------------------------|-----------|--------------------------------|-------------------------|
| Trace noise ² , typical | | 300 KHz to < 200 MHz | 200 MHz to 6 GHz |
| | Magnitude | 0.008 dB RMS | 0.006 dB RMS |
| | Phase | 0.05 degrees RMS | 0.04 degrees RMS |

| | | | |
|--|-----------|-------------------------|----------------------------|
| Temperature stability ³ , typical | | 300 KHz to 3 GHz | > 3 GHz to 6 GHz |
| | Magnitude | 0.008 dB/°C | 0.015 dB/°C |
| | Phase | 0.1 degrees/°C | 0.2 degrees/°C |

Maximum receiver input level

| | | | |
|----------------|-----------|--------------------|--------------------------|
| | DC | < 10 MHz | ≥ 10 MHz to 6 GHz |
| Operational | ± 24 V | 10 dBm | 10 dBm |
| Without damage | ± 30 V | 15 dBm | 20 dBm |

Output level calibration

| Manufacturer | Supported power sensors |
|-------------------------------------|--|
| Tektronix USB power sensors | PSM3000 series PSM4000 series PSM5000 series |
| Keysight USB power sensors | U848x series U2020 series U2000 series |
| Rohde and Schwarz USB power sensors | NRP-Z power sensors NRP-xxS/SN power sensors |

Connectors

Front panel



| Name | Function | Description |
|--------|------------------------|-------------------------|
| Port 1 | VNA measurement port 1 | Type N female conductor |
| Port 2 | VNA measurement port 2 | Type N female conductor |
| LO A | LO A In/Out | SMA female conductor |
| LO B | LO B In/Out | SMA female conductor |
| Power | Power indicator | Red/green LED |

² Measured in a 1 KHz IF BW, 10 dBm output power, thru connection

³ Measured in a 10 Hz IF BW, 0 dBm output power, thru connection

Connectors

Rear panel



| Name | Function | Specifications | Connector |
|----------|---------------------------------------|--|--|
| Bias 1 | Port 1 bias tee connection | ± 24 VDC ± 200 mA maximum | BNC Female |
| Bias 2 | Port 2 bias tee connection | | |
| Ref Out | 10 MHz reference output | 10 MHz ± 60 Hz > 5 dBm | |
| Ref In | 10 MHz reference input | 10 MHz ± 50 Hz -5 dBm to + 10 dBm | |
| Trigger | Trigger input | TTL ± Edge, ± Level > 250 µS duration (10 mS max.) | |
| Aux Sync | Auxiliary trigger | TTL | |
| DC input | Power supply | 4.752 to 5.25 VDC | 2.5 x 5.5 x 9.5 mm barrel connector Center positive |
| USB 2.0 | USB connector for computer connection | USB 2.0 | USB 2.0 B connector |

Power supply

| Tektronix part number | Input | Output |
|-----------------------|--|--------------------------|
| 119-8763-01 | 100 to 240 V AC, 50/60 Hz IEC60320 C14 receptacle | + 5 V ±1% 4 A maximum |

VectorVu-PC™ software

System requirements

| | Processor | Memory | Drive |
|---|-----------------|--------|-------|
| Best | Intel® Core™ i7 | 8 GB | SSD |
| Recommended | Intel® Core™ i3 | 8 GB | SSD |
| Minimum | Intel® Core™ i3 | 8 GB | HDD |
| Operating system: Windows® 7 or greater, 64-bit | | | |

Physical characteristics

Length: 11.25" (28.58 cm)

Width: 8.125" (20.64 cm)

Depth: 1.75" (4.45 cm)

Weight: 3.5 lbs. (1.59 kg)

Environmental and safety

Temperature

Operating: +5 °C to +50 °C (41 °F to 122 °F)

Non-operating: -40 °C to 71 °C (-40 °F to 159.8 °F)

Humidity (operating)

5% to 80% ±5%RH (relative humidity) in the temperature range of +10 °C to 30 °C (+50 °F to 86 °F)

5% to 75% ±5%RH above +30 °C to 40 °C (+86 °F to 104 °F)

5% to 45% ±5%RH above +40 °C up to 50 °C (+104 °F to +122 °F)

Non-condensing

Altitude

Operating: 5000 m (16,404 ft)

Non-operating: 15,240 m (50,000 ft)

Dynamics

Vibration

Operating: 0.31 GRMS: 5-500 Hz, 3 Axes at 10 min/axis

Non-operating: 2.46 GRMS: 5-500 Hz, 3 Axes at 10 min/axis

Shock

Operating: Half-sine mechanical shocks, 30 g peak amplitude, 11 msec duration, 3 drops in each direction of each axis, 18 total

Non-operating: Half-sine mechanical shocks, 40 g peak amplitude, 11 msec duration, 3 drops in each direction of each axis, 18 total

Handling and transit

Bench handling, operating: MIL-PRF-28800F Class 3

Transit drop, non-operating: MIL-PRF-28800F Class 2

Ordering information

Models

| | |
|---------|---|
| TTR503A | USB Vector Network Analyzer, 100 kHz to 3 GHz |
| TTR506A | USB Vector Network Analyzer, 100 kHz to 6 GHz |

Software license options

| | |
|-------------|--|
| VVPC-TDR-NL | License; Time Domain with Gating software for VVPC/TTR500; Node Locked |
| VVPC-TDR-FL | License; Time Domain with Gating software for VVPC/TTR500; Floating |

Power plug options

| | |
|----------|--|
| Opt. A0 | North America power plug (115 V, 60 Hz) |
| Opt. A1 | Universal Euro power plug (220 V, 50 Hz) |
| Opt. A2 | United Kingdom power plug (240 V, 50 Hz) |
| Opt. A3 | Australia power plug (240 V, 50 Hz) |
| Opt. A5 | Switzerland power plug (220 V, 50 Hz) |
| Opt. A6 | Japan power plug (100 V, 50/60 Hz) |
| Opt. A10 | China power plug (50 Hz) |
| Opt. A11 | India power plug (50 Hz) |
| Opt. A12 | Brazil power plug (60 Hz) |
| Opt. A99 | No power cord |

Service options

| | |
|-----------|---|
| Opt. C3 | Calibration Service 3 Years |
| Opt. C5 | Calibration Service 5 Years |
| Opt. D1 | Calibration Data Report |
| Opt. D3 | Calibration Data Report 3 Years (with Opt. C3) |
| Opt. D5 | Calibration Data Report 5 Years (with Opt. C5) |
| Opt. G3 | Complete Care 3 Years (includes loaner, scheduled calibration, and more) |
| Opt. G5 | Complete Care 5 Years (includes loaner, scheduled calibration, and more) |
| Opt. R5 | Repair Service 5 Years (including warranty) |
| Opt. R5DW | Repair Service Coverage 5 Years (includes product warranty period). 5-year period starts at time of instrument purchase |

Warranty

Three year warranty

Accessories

Carrying case and rackmount

| Description | Name |
|----------------------|---------------|
| TTR500 Carrying case | TTR500TRANSIT |
| TTR500 Rackmount kit | TTR500RACK |

Calibration kits

| Description | Name |
|---|--------------|
| TCAL500 automatic calibration module, 6 GHz, 3.5mm female connectors, comes with rugged carrying case, torque wrench | TCAL500-35F |
| TCAL500 automatic calibration module, 6 GHz, 3.5mm male + 3.5mm female connectors, comes with rugged carrying case, torque wrench | TCAL500-35MF |
| TCAL500 automatic calibration module, 6 GHz, 3.5mm male connectors, comes with rugged carrying case, torque wrench | TCAL500-35M |
| TCAL500 automatic calibration module, 6 GHz, N-type female connectors, comes with rugged carrying case, torque wrench | TCAL500-NF |
| TCAL500 automatic calibration module, 6 GHz, N-type male + N-type female connectors, comes with rugged carrying case, torque wrench | TCAL500-NMF |
| TCAL500 automatic calibration module, 6 GHz, N-type male connectors, comes with rugged carrying case, torque wrench | TCAL500-NM |
| 7/16 SOLT mechanical calibration kit 0 to 7.5 GHz (Spinner BN 53 38 40) | CALMECH-716 |
| Type-N SOLT mechanical calibration kit 0 to 18 GHz (Spinner BN 53 38 61) | CALMECH-N |
| 3.5mm SOLT mechanical calibration kit 0 to 32 GHz (Spinner BN 53 38 54) | CALMECH-35MM |
| 7/16 SOLT mechanical calibration kit MF Thru Option 0 to 7.5 GHz (Spinner BN 75 63 01 R000) | THRU-716-FM |
| Type-N SOLT mechanical calibration kit MF Thru Option 0 to 18 GHz (Spinner BN 533918R000) | THRU-N-FM |
| 3.5mm SOLT mechanical calibration kit MF Thru Option 0 to 32 GHz (Spinner BN 533769R000) | THRU-35MM-FM |
| 3.5 mm female SOLT 4-in-one kit | CALSOLT35F |
| 3.5 mm male SOLT 4-in-one kit | CALSOLT35M |
| 7/16 female SOLT 4-in-one kit | CALSOLT716F |
| 7/16 male SOLT 4-in-one kit | CALSOLT716M |
| Type N female SOLT 4-in-one kit | CALSOLTNF |
| Type N female SOLT 4-in-one kit 75 Ω | CALSOLTNF-75 |
| Type N male SOLT 4-in-one kit | CALSOLTNM |
| Type N male SOLT 4-in-one kit 75 Ω | CALSOLTNM-75 |

Cables

| Description | Part number |
|---|-------------|
| Cable, Rugged, Phase-stable, Type-N(m) to Type-N(m), 60 cm | 012-1768-00 |
| Cable, Rugged, Phase-stable, Type-N(m) to Type-N(f), 60 cm | 012-1765-00 |
| Cable, Rugged, Phase-stable, Type-N(m) to Type-N(m), 3.28 ft. (1 m) | 012-1767-00 |
| Cable, Rugged, Phase-stable, Type-N(m) to Type-N(f), 3.28 ft. (1 m) | 012-1766-00 |
| Cable, Rugged, Phase-stable, Type-N(m) to Type-N(m), 5 ft. (1.5 m) | 012-1746-00 |
| Cable, Rugged, Phase-stable, Type-N(m) to Type-N(f), 5 ft. (1.5 m) | 012-1745-00 |
| Cable, Rugged, Phase-stable, Type-N(m) to 7/16(f), 60 cm | 012-1747-00 |
| Cable, Rugged, Phase-stable, Type-N(m) to 7/16(m), 60 cm | 012-1752-00 |
| Cable, Rugged, Phase-stable, Type-N(m) to 7/16(m), 3.28 ft. (1 m) | 012-1750-00 |
| Cable, Rugged, Phase-stable, Type-N(m) to 7/16(f), 3.28 ft. (1 m) | 012-1748-00 |
| Cable, Rugged, Phase-stable, Type-N(m) to 7/16(m), 5 ft. (1.5 m) | 012-1751-00 |
| Cable, Rugged, Phase-stable, Type-N(m) to 7/16(f), 5 ft. (1.5 m) | 012-1749-00 |
| Cable, Rugged, Phase-stable, Type-N(m) to DIN 9.5(f), 60 cm | 012-1753-00 |
| Cable, Rugged, Phase-stable, Type-N(m) to DIN 9.5(m), 60 cm | 012-1758-00 |
| Cable, Rugged, Phase-stable, Type-N(m) to DIN 9.5(m), 3.28 ft. (1 m) | 012-1756-00 |
| Cable, Rugged, Phase-stable, Type-N(m) to DIN 9.5(f), 3.28 ft. (1 m) | 012-1754-00 |
| Cable, Rugged, Phase-stable, Type-N(m) to DIN 9.5(m), 5 ft. (1.5 m) | 012-1757-00 |
| Cable, Rugged, Phase-stable, Type-N(m) to DIN 9.5(f), 5 ft. (1.5 m) | 012-1755-00 |
| Cable, Rugged, Phase-stable, Type-N(m) to TNC(m), 60 cm | 012-1762-00 |
| Cable, Rugged, Phase-stable, Type-N(m) to TNC(f), 60 cm | 012-1761-00 |
| Cable, Rugged, Phase-stable, Type-N(m) to TNC(m), 3.28 ft. (1 m) | 012-1763-00 |
| Cable, Rugged, Phase-stable, Type-N(m) to TNC(f), 3.28 ft. (1 m) | 012-1759-00 |
| Cable, Rugged, Phase-stable, Type-N(m) to TNC(m), 5 ft. (1.5 m) | 012-1764-00 |
| Cable, Rugged, Phase-stable, Type-N(m) to TNC(f), 5 ft. (1.5 m) | 012-1760-00 |
| Cable, Rugged, Phase-stable, Type-N(m) to Type-SMA(m) 60 cm | 012-1772-00 |
| Cable, Rugged, Phase-stable, Type-N(m) to Type-SMA(f), 60 cm | 012-1769-00 |
| Cable, Rugged, Phase-stable, Type-N(m) to Type-SMA(m), 3.28 ft. (1 m) | 012-1773-00 |
| Cable, Rugged, Phase-stable, Type-N(m) to Type-SMA(f), 3.28 ft. (1 m) | 012-1770-00 |
| Cable, Rugged, Phase-stable, Type-N(m) to Type-SMA(m), 5 ft. (1.5 m) | 012-1774-00 |
| Cable, Rugged, Phase-stable, Type-N(m) to Type-SMA(f), 5 ft. (1.5 m) | 012-1771-00 |

Adapters

| Description | Part number |
|---|-------------|
| Adapter, Coaxial, 50 Ohm Type-N(f) to Type-N(f) | 013-0410-00 |
| Adapter, Coaxial, 50 Ohm Type-N(m) to Type-N(f) | 013-0411-00 |
| Adapter, Coaxial, 50 Ohm, Type-N(m) to Type-N(m) | 013-0412-00 |
| Adapter, Coaxial, 50 Ohm Type-N(m) to Type-N 7/16(m) | 013-0402-00 |
| Adapter, Coaxial, 50 Ohm Type-N(m) to Type-7/1 (f) | 013-0404-00 |
| Adapter, Coaxial, 50 Ohm Type-N(m) to Type DIN 9.5(m) | 013-0403-00 |
| Adapter, Coaxial, 50 Ohm Type-N(m) to Type-DIN 9.5(f) | 013-0405-00 |
| Adapter, Coaxial, 50 Ohm Type-N(m) to Type-SMA(f) | 013-0406-00 |
| Adapter, Coaxial, 50 Ohm Type-N(m) to Type-SMA(m) | 013-0407-00 |
| Adapter, Coaxial, 50 Ohm Type-N(m) to Type-TNC(f) | 013-0408-00 |
| Adapter, Coaxial, 50 Ohm Type-N(m) to Type-TNC(m) | 013-0409-00 |



Tektronix is registered to ISO 9001 and ISO 14001 by SRI Quality System Registrar.



Product(s) complies with IEEE Standard 488.1-1987, RS-232-C, and with Tektronix Standard Codes and Formats.



Product Area Assessed: The planning, design/development and manufacture of electronic Test and Measurement instruments.

ASEAN / Australasia (65) 6356 3900
Belgium 00800 2255 4835*
Central East Europe and the Baltics +41 52 675 3777
Finland +41 52 675 3777
Hong Kong 400 820 5835
Japan 81 (3) 6714 3086
Middle East, Asia, and North Africa +41 52 675 3777
People's Republic of China 400 820 5835
Republic of Korea +822 6917 5084, 822 6917 5080
Spain 00800 2255 4835*
Taiwan 886 (2) 2656 6688

Austria 00800 2255 4835*
Brazil +55 (11) 3759 7627
Central Europe & Greece +41 52 675 3777
France 00800 2255 4835*
India 000 800 650 1835
Luxembourg +41 52 675 3777
The Netherlands 00800 2255 4835*
Poland +41 52 675 3777
Russia & CIS +7 (495) 6647564
Sweden 00800 2255 4835*
United Kingdom & Ireland 00800 2255 4835*

Balkans, Israel, South Africa and other ISE Countries +41 52 675 3777
Canada 1 800 833 9200
Denmark +45 80 88 1401
Germany 00800 2255 4835*
Italy 00800 2255 4835*
Mexico, Central/South America & Caribbean 52 (55) 56 04 50 90
Norway 800 16098
Portugal 80 08 12370
South Africa +41 52 675 3777
Switzerland 00800 2255 4835*
USA 1 800 833 9200

* European toll-free number. If not accessible, call: +41 52 675 3777

For Further Information. Tektronix maintains a comprehensive, constantly expanding collection of application notes, technical briefs and other resources to help engineers working on the cutting edge of technology. Please visit www.tek.com.

Copyright © Tektronix, Inc. All rights reserved. Tektronix products are covered by U.S. and foreign patents, issued and pending. Information in this publication supersedes that in all previously published material. Specification and price change privileges reserved. TEKTRONIX and TEK are registered trademarks of Tektronix, Inc. All other trade names referenced are the service marks, trademarks, or registered trademarks of their respective companies.



02 Jul 2019 70W-61132-1

